

User's Guide

Designer Sapphire™ | 85

This household sewing machine is designed to comply with IEC/EN 60335-1, 60335-2-28, CSA C22.2 NO.68 and UL1594.

IMPORTANT SAFETY INSTRUCTIONS

When using an electrical appliance, basic safety precautions should always be followed, including the following:

Read all instructions before using this household sewing machine. Keep the instructions at a suitable place close to the machine. Make sure to hand them over if the machine is given to a third party.

DANGER –TO REDUCE THE RISK OF ELECTRIC SHOCK:

- A sewing machine should never be left unattended when plugged in. The electrical socket, to which the machine is plugged in should be easily accessible. Always unplug this sewing machine from the electric outlet immediately after using and before cleaning, removing covers, lubricating or when making any other user servicing adjustments mentioned in the instruction manual.

WARNING –TO REDUCE THE RISK OF BURNS, FIRE, ELECTRIC SHOCK, OR INJURY TO PERSON:

- Do not allow to be used as a toy. Close attention is necessary when this sewing machine is used by or near children.
- Use this sewing machine only for its intended use as described in this manual. Use only attachments recommended by the manufacturer as contained in this manual.
- Never operate this sewing machine if it has a damaged cord or plug, if it is not working properly, if it has been dropped or damaged, or dropped into water. Return the sewing machine to the nearest authorized dealer or service center for examination, repair, electrical or mechanical adjustment.
- Never operate the sewing machine with any air openings blocked. Keep ventilation openings of the sewing machine and foot control free from the accumulation of lint, dust, and loose cloth.
- Keep fingers away from all moving parts. Special care is required around the sewing machine needle.
- Always use the proper needle plate. The wrong plate can cause the needle to break.
- Do not use bent needles.
- Do not pull or push fabric while stitching. It may deflect the needle causing it to break.
- Wear safety glasses.
- Switch the sewing machine off (“0”) when making any adjustment in the needle area, such as threading needle, changing needle, threading bobbin, or changing presser foot, etc.
- Never drop or insert any object into any opening.
- Do not use outdoors.
- Do not operate where aerosol (spray) products are being used or where oxygen is being administered.
- To disconnect, turn all controls to the off (“0”) position, then remove plug from outlet.
- Do not unplug by pulling on cord. To unplug, grasp the plug, not the cord.
- The foot control is used to operate the machine. Never place other objects on the foot control.

- Do not use the machine if it is wet.
- If the LED lamp is damaged or broken, it must be replaced by the manufacturer or its service agent or a similarly qualified person, in order to avoid a hazard.
- If the cord connected with the foot control is damaged, it must be replaced by the manufacturer or its service agent or a similarly qualified person, in order to avoid a hazard.
- This sewing machine is provided with double insulation. Use only identical replacement parts. See instructions for Servicing of Double-Insulated Appliances.

SAVE THESE INSTRUCTIONS

FOR CENELEC COUNTRIES ONLY:

This appliance can be used by children aged from 8 years and above and persons with reduced physical, sensory or mental capabilities or lack of experience and knowledge if they have been given supervision or instruction concerning use of the appliance in a safe way and understand the hazards involved. Children shall not play with the appliance. Cleaning and user maintenance shall not be made by children without supervision.

The noise level under normal operating conditions is less than 80dB(A).

The machine must only be used with foot control of type FR5 manufactured by Shanghai Binao Precision Mould Co., Ltd.

FOR NON CENELEC COUNTRIES:

This sewing machine is not intended for use by persons (including children) with reduced physical, sensory or mental capabilities, or lack of experience and knowledge, unless they have been given supervision or instruction concerning use of the sewing machine by a person responsible for their safety. Children should be supervised to ensure that they do not play with the sewing machine.

The noise level under normal operating conditions is less than 80dB(A).

The machine must only be used with foot control of type FR5 manufactured by Shanghai Binao Precision Mould Co., Ltd.

SERVICING OF DOUBLE INSULATED PRODUCTS

In a double-insulated product, two systems of insulation are provided instead of grounding. No ground means is provided on a double-insulated product, nor should a means for grounding be added to the product. Servicing of a double-insulated product requires extreme care and knowledge of the system and should be done only by qualified service personnel. Replacement parts for a double-insulated product must be identical to those parts in the product. A double-insulated product is marked with the words 'DOUBLE INSULATION' or 'DOUBLE INSULATED'.

Federal Communication Commission Interference Statement

For the USA and Canada

Responsible party: Singer Sourcing Limited LLC
1714 Heil Quaker Boulevard, Suite 130, LaVergne, TN 37086

Product name: HUSQVARNA® VIKING® DESIGNER SAPPHIRE™ 85 sewing machine

Model number: SFV1

This device complies with Part 15 of the FCC Rules. Operation is subject to the following two conditions: (1) This device may not cause harmful interference, and (2) this device must accept any interference received, including interference that may cause undesired operation.

To satisfy radio frequency exposure requirements, a separation distance of 8" (20 cm) or more should be maintained between this device and persons during device operation. To ensure compliance, operations at closer than this distance is not recommended. The built-in antenna used for this transmitter must not be co-located in conjunction with any other antenna or transmitter.

This equipment has been tested and found to comply with the limits for a Class B digital device, pursuant to Part 15 of the FCC Rules. These limits are designed to provide reasonable protection against harmful interference in a residential installation. This equipment generates, uses and can radiate radio frequency energy and, if not installed and used in accordance with the instructions, may cause harmful interference to radio communications. However, there is no guarantee that interference will not occur in a particular installation. If this equipment does cause harmful interference to radio or television reception, which can be determined by turning the equipment off and on, the user is encouraged to try to correct the interference by one of the following measures:

- Reorient or relocate the receiving antenna.
- Increase the separation between the equipment and receiver.
- Connect the equipment into an outlet on a circuit different from that to which the receiver is connected.
- Consult the authorized HUSQVARNA® VIKING® retailer or an experienced radio/TV technician for help.

The included interface cable should be used in order to ensure compliance with the limits for a Class B digital device.



Any changes or modifications not expressly approved by the party responsible for compliance could void the user's authority to operate this equipment.

Declaration of Conformity

For Europe

Hereby, VSM Group AB on behalf of Singer Sourcing Limited LLC (who are commonly owned by SVP-SINGER Holdings LLC, d/b/a collectively as SVP Worldwide), declares that this sewing machine is in compliance with the essential requirements and other relevant provisions of Directive 2014/53/EU. To view a copy of the Declaration of Conformity, please see RC-0234.

To satisfy radio frequency exposure requirements, a separation distance of 8" (20 cm) or more should be maintained between this device and persons during device operation. To ensure compliance, operations at closer than this distance is not recommended. The built-in antenna used for this transmitter must not be co-located in conjunction with any other antenna or transmitter.

TABLE OF CONTENTS

| | | | | |
|----------|---|-----------|--|--|
| I | Introduction | 11 | | |
| | Machine Overview | 12 | | |
| | Front | 12 | | |
| | Needle Area | 13 | | |
| | Rear | 13 | | |
| | Accessory Tray | 13 | | |
| | Embroidery Unit..... | 13 | | |
| | Function Buttons..... | 14 | | |
| | Speed..... | 14 | | |
| | Needle Stop Up/Down..... | 14 | | |
| | Cut Function..... | 14 | | |
| | Reverse | 14 | | |
| | START/STOP | 15 | | |
| | FIX function | 15 | | |
| | STOP function | 15 | | |
| | Presser Foot Down and Pivot..... | 15 | | |
| | Presser Foot Up and Extra Lift..... | 15 | | |
| | Accessories..... | 16 | | |
| | Included Accessories | 16 | | |
| | Included Hoops | 16 | | |
| | Presser Feet..... | 17 | | |
| | Stitch Overview..... | 19 | | |
| | Utility Stitches | 19 | | |
| | Stitch Menu Overview | 23 | | |
| | Alphabets | 23 | | |
| | Basic Gestures for the Multi-Touch Screen | 24 | | |
| | Smart Toolbox..... | 24 | | |
| 2 | Preparations | 25 | | |
| | Unpacking Machine and Embroidery Unit..... | 26 | | |
| | Connect the Power Cord and Foot | | | |
| | Control..... | 26 | | |
| | Pack Away After Sewing | 27 | | |
| | USB Port | 27 | | |
| | Using a USB device | 27 | | |
| | Getting Started with WiFi and <i>mySewnet</i> [™] Cloud | 28 | | |
| | LED Lights | 28 | | |
| | Free Arm..... | 28 | | |
| | Manual Thread Cutter | 28 | | |
| | Thread Sensor | 29 | | |
| | Spool Pins..... | 29 | | |
| | Horizontal Position | 29 | | |
| | Vertical Position..... | 29 | | |
| | Auxiliary Spool Pin..... | 30 | | |
| | Threads | 31 | | |
| | Needles..... | 32 | | |
| | Important Needle Information..... | 32 | | |
| | Changing the Needle..... | 33 | | |
| | Threading the Upper Thread..... | 33 | | |
| | Horizontal Spool Pin | 33 | | |
| | Needle threader | 34 | | |
| | Selecting Correct Thread/Needle Combination | 35 | | |
| | Threading for Twin Needle..... | 36 | | |
| | Bobbin Winding..... | 37 | | |
| | Bobbin Winding through the Needle | 37 | | |
| | Winding Specialty Threads..... | 37 | | |
| | Bobbin Winding while Embroidering or Sewing | 38 | | |
| | Inserting the Bobbin..... | 38 | | |
| | Changing the Presser Foot..... | 38 | | |
| | Attaching the Sensor One-Step Buttonhole Foot | 39 | | |
| | Attaching the Sensor Q-Foot..... | 39 | | |
| | Interchangeable Dual Feed Foot | 39 | | |
| | Changing to Straight Stitch Plate | 40 | | |
| 3 | Embroidery Preparations | 41 | | |
| | Embroidery Unit..... | 42 | | |
| | Embroidery Hoop Overview..... | 42 | | |
| | Sensor Q-Foot..... | 42 | | |
| | Straight Stitch Plate..... | 42 | | |
| | Designs..... | 43 | | |
| | DESIGNER SAPPHIRE [™] 85 Sampler Book ... | 43 | | |
| | Connect the Embroidery Unit..... | 43 | | |
| | Remove the Embroidery Unit..... | 43 | | |
| | Hoop the Fabric | 44 | | |
| | Slide on/off the Hoop | 44 | | |
| 4 | The Multi-Touch Screen | 45 | | |
| | Common Functions..... | 46 | | |
| | OK..... | 46 | | |
| | Cancel..... | 46 | | |
| | Embroidery Edit..... | 46 | | |
| | Embroidery Stitch Out..... | 46 | | |
| | Touch & Hold | 46 | | |
| | Topbar | 47 | | |
| | WiFi | 47 | | |
| | <i>mySewnet</i> [™] | 48 | | |
| | Wireless Firmware Update..... | 48 | | |
| | Home Screen..... | 48 | | |
| | Quick Help | 49 | | |
| | Settings | 49 | | |
| | Sewing/Embroidery Mode Toggle | 49 | | |
| 5 | WiFi & <i>mySewnet</i>[™] Services..... | 51 | | |
| | WiFi Introduction | 52 | | |
| | Getting Started With WiFi..... | 52 | | |
| | Hidden Network..... | 52 | | |
| | Firmware Update Using WiFi..... | 53 | | |
| | Firmware Update Using a USB Device..... | 53 | | |
| | Complimentary Software (PC and MAC) | 54 | | |
| | <i>mySewnet</i> [™] Services..... | 55 | | |
| | <i>mySewnet</i> [™] Account..... | 55 | | |

| | | | |
|--|-----------|---|-----------|
| <i>mySewnet</i> [™] Cloud | 56 | Baste..... | 86 |
| Installation of <i>mySewnet</i> [™] Cloud Sync Tool | | Blind Hem..... | 87 |
| for Computer | 57 | Hem..... | 87 |
| Apps..... | 57 | Buttonholes | 88 |
| <i>mySewnet</i> [™] Menu | 57 | Programmable Button Sew On..... | 89 |
| <i>mySewnet</i> [™] Library | 57 | Dimensional Stitches – Menu L..... | 89 |
| <i>mySewnet</i> [™] Blog..... | 57 | Theme Stitches – Menu M..... | 89 |
| 6 Home Screen | 59 | Embellished Stitches – Menu N | 90 |
| Home Screen— Overview..... | 60 | Tapering Stitches – Menu Q | 90 |
| User Profile..... | 61 | Taper Satin Stitch Exercise..... | 91 |
| Welcome Center..... | 61 | 4-Way Stitches – Menu S..... | 92 |
| <i>mySewnet</i> [™] Blog..... | 61 | 8-Way Stitches – Menu T | 93 |
| Filter <i>mySewnet</i> [™] Blog Posts..... | 61 | Special Stitches For Optional Presser Feet..... | 93 |
| Minimize/expand <i>mySewnet</i> [™] Blog..... | 61 | Sewing Pop-up Messages..... | 94 |
| Home Screen — Common Functions | 62 | 8 Embroidery Edit..... | 95 |
| Search | 62 | Getting Started to Embroider..... | 96 |
| Minimize/Expand Project files..... | 62 | Embroidery Edit – Overview..... | 97 |
| Start New | 62 | Grid/Background Color | 98 |
| Continue | 62 | Background color..... | 98 |
| Load Smart Save | 63 | Alignment..... | 98 |
| Project Menu..... | 63 | Grid options | 98 |
| Project Viewer..... | 63 | <i>mySewnet</i> [™] Library..... | 99 |
| JoyOS ADVISOR [™] | 66 | Load a Design..... | 99 |
| SEWING ADVISOR [™] – Overview | 66 | Load a Stitch..... | 100 |
| QUILT ADVISOR– Overview..... | 69 | Load a Font | 100 |
| EMBROIDERY ADVISOR [™] – Overview | 70 | File Manager | 100 |
| Knowledge Center – Overview..... | 71 | How to Select Designs | 100 |
| 7 Sewing..... | 73 | Hoop Selection..... | 102 |
| Getting Started to Sew..... | 74 | Arrange | 102 |
| Sewing Mode – Overview | 75 | Multi-Select..... | 102 |
| What is a Stitch? | 76 | Select All | 102 |
| Select a Stitch or Letter | 76 | Group/Ungroup..... | 103 |
| Load a Stitch or Letter From Another | | Stitch Out Design Before/After..... | 103 |
| Location..... | 76 | Edit Functions | 103 |
| Sewing Recommendations..... | 77 | Move to Hoop..... | 103 |
| Stitch Settings | 77 | Delete | 103 |
| Stitch Width..... | 78 | Duplicate..... | 103 |
| Stitch Positioning | 78 | Mirror Side to Side and End to End | 104 |
| Stitch Length..... | 78 | Touch Functions..... | 104 |
| Stitch Density..... | 79 | Position..... | 104 |
| Button Size | 79 | Rotate | 104 |
| Sew On Button..... | 79 | Scale | 105 |
| Sensor Foot Pressure | 80 | Pan..... | 105 |
| <i>deLuxe</i> [™] Stitch System..... | 80 | Zoom | 105 |
| Mirroring..... | 81 | Zoom Options | 106 |
| Stitch Re-Start | 81 | Undo/Redo..... | 106 |
| Save Stitch | 82 | Design Stitch Out Order | 106 |
| Smart Save..... | 82 | Total Number of Stitches in Design | |
| Balance | 83 | Combination..... | 106 |
| Free Motion Options..... | 84 | Save Design | 107 |
| Basic Sewing Techniques..... | 86 | Smart Save | 107 |
| Seam..... | 86 | Send Design..... | 108 |
| Overcast..... | 86 | GO..... | 108 |
| Seam and Overcast..... | 86 | | |

| | | | |
|---|------------|---|------------|
| Edit an Existing Design or Text..... | 108 | Embroidery Stitch Out Pop-up Messages | 135 |
| Thread Color Edit..... | 109 | | |
| Program Embroidery Text..... | 111 | 10 Program | 137 |
| Create a Text..... | 111 | Program – Overview..... | 138 |
| Add a Letter..... | 111 | Create New Program..... | 139 |
| Delete a Letter..... | 111 | To Edit a Created Program..... | 140 |
| Text Shaping..... | 111 | Edit Stitch or Lettering Program..... | 140 |
| Design Shaping..... | 113 | Adjust the Entire Program..... | 141 |
| Select Spacing..... | 114 | Stitch Program Commands..... | 141 |
| Select Line Positioning..... | 114 | Save Program..... | 142 |
| Select Side Positioning..... | 115 | Sew or Embroider Your Stitch Program..... | 142 |
| Fixed Design Angle..... | 115 | Program Pop-Up Messages..... | 142 |
| Set Number of Designs..... | 115 | | |
| Design Appliqué..... | 116 | 11 Settings..... | 145 |
| Resize..... | 117 | Temporary Sewing Settings..... | 146 |
| Resize Adjustments..... | 117 | <i>deLuxe</i> [™] Stitch System..... | 146 |
| Start Resizing..... | 118 | Sensor Presser Foot Lift..... | 146 |
| Important Resize Information..... | 118 | Automatic Thread Cutter..... | 147 |
| Embroidery Edit Pop-up Messages..... | 119 | Automatic FIX..... | 147 |
| | | Stitch Limiting Options..... | 147 |
| | | Feed Teeth Options..... | 148 |
| | | Temporary Embroidery Settings..... | 149 |
| 9 Embroidery Stitch Out..... | 121 | <i>deLuxe</i> [™] Stitch System..... | 149 |
| Embroidery Stitch Out – Overview..... | 122 | Embroidery Foot Type..... | 150 |
| Welcome to Embroidery Stitch Out..... | 123 | Thread Cut Options..... | 150 |
| Color Block List..... | 124 | Twin Needle Options..... | 151 |
| Zoom..... | 124 | Default Sewing Settings..... | 152 |
| Zoom Options..... | 125 | <i>deLuxe</i> [™] Stitch System – Default..... | 152 |
| Corner Check..... | 125 | Sensor Presser Foot Lift – Default..... | 152 |
| Hoop Position Options..... | 125 | Automatic Thread Cutter – Default..... | 152 |
| Current Stitch Position..... | 125 | Automatic FIX – Default..... | 152 |
| Park Position..... | 125 | Free Motion Options – Default..... | 152 |
| Trim Position..... | 125 | Default Embroidery Settings..... | 153 |
| Center/Remove Hoop Position..... | 126 | <i>deLuxe</i> [™] Stitch System – Default..... | 153 |
| Design Positioning..... | 127 | Thread Cut Options – Default..... | 153 |
| Design Positioning Wizard..... | 128 | Embroidery Pivot Height – Default..... | 153 |
| Zoom to Cursor..... | 129 | My Hoops..... | 153 |
| Set Cursor Point..... | 129 | Machine Settings..... | 154 |
| <i>deLuxe</i> [™] Stitch System..... | 129 | Language..... | 154 |
| Smart Save..... | 130 | Audio Volume..... | 154 |
| Auto Smart Save..... | 130 | Audio Repeat..... | 154 |
| Thread Color Spools..... | 130 | Machine Nickname..... | 154 |
| Return to Embroidery Edit..... | 131 | Color Theme..... | 154 |
| Step Stitch-by-Stitch/Go to Stitch..... | 131 | Lock Screen..... | 154 |
| Number of Stitches in Current Color | | LED Work Light Brightness..... | 154 |
| Block..... | 131 | Units..... | 154 |
| Number of Stitches in Embroidery | | Clock Settings..... | 155 |
| Combination..... | 131 | Usage..... | 155 |
| Remaining Embroidery Time by Color | | WiFi Settings..... | 156 |
| Block..... | 131 | <i>mySewnet</i> [™] Settings..... | 156 |
| Color Options..... | 132 | Machine Information..... | 156 |
| Color Block Sort..... | 132 | | |
| Color Block Merge..... | 132 | 12 File Manager | 157 |
| Monochrome..... | 132 | File Manager – Overview..... | 158 |
| Highlight Current Color Block..... | 133 | File Formats..... | 159 |
| Basting Options..... | 134 | | |

| | |
|---|------------|
| Browse File Manager..... | 159 |
| Open a File or Folder..... | 159 |
| Move Up One Folder Level | 160 |
| List/Thumbnail View | 160 |
| mySewnet™ Cloud Folder | 160 |
| Built-in Designs | 160 |
| USB Device | 160 |
| Organize..... | 161 |
| Create New Folder | 161 |
| Rename a File or Folder | 161 |
| Move a File or Folder..... | 161 |
| Copy a File or Folder..... | 161 |
| Delete a File or Folder | 161 |
| Toggle Between Edit and Filter View..... | 162 |
| Filter Files..... | 162 |
| File Manager Pop-up Messages | 163 |
| 13 Maintenance | 164 |
| Cleaning the Machine Exterior..... | 165 |
| Removing the Needle Plate and Cleaning the Bobbin Area | 165 |
| Cleaning Under the Bobbin Area..... | 165 |
| Replacing the Needle Plate..... | 165 |
| Troubleshooting..... | 166 |
| Troubleshooting Connectivity | 169 |
| Service | 169 |
| Non-Original Parts and Accessories | 169 |
| Technical Specification | 170 |
| Index | 171 |

I Introduction

Machine Overview

Front

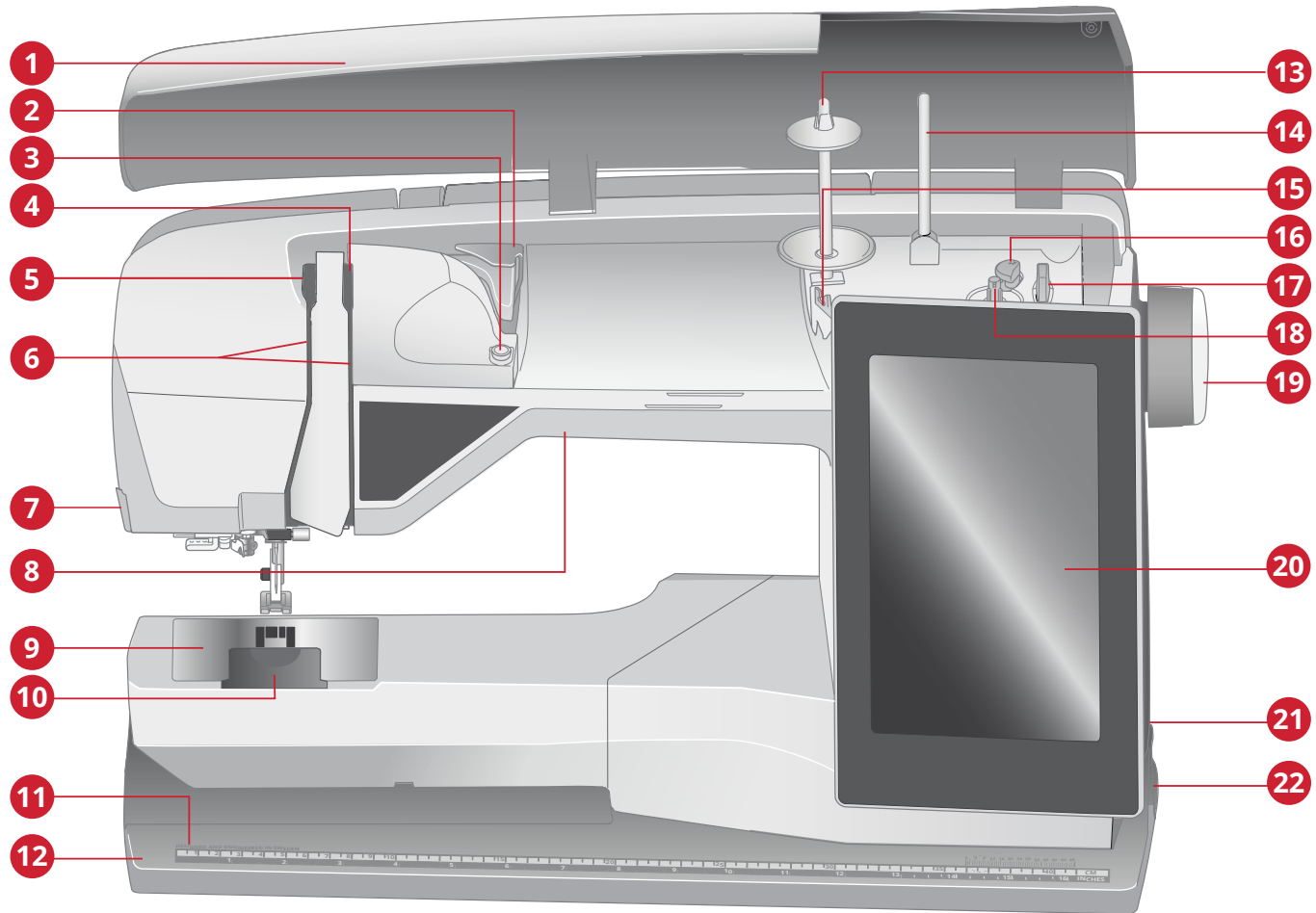

- | | |
|---|---|
| 1. Lid | 13. Main spool pin |
| 2. Pre-tension thread guide | 14. Auxiliary spool pin |
| 3. Thread tension disc for bobbin winding | 15. Bobbin winding thread guides |
| 4. Thread tension discs | 16. Bobbin winding lever |
| 5. Thread take-up lever | 17. Thread cutter for bobbin winding |
| 6. Threading slots | 18. Bobbin winder |
| 7. Thread cutter | 19. Handwheel |
| 8. LED light | 20. Multi-touch screen |
| 9. Needle plate | 21. Built-in USB ports |
| 10. Bobbin cover | 22. ON/OFF switch, connectors for power cord and foot control |
| 11. Built-in ruler with button ruler | |
| 12. Base plate | |

Needle Area

1. Built-in needle threader handle
2. Needle bar
3. Needle clamp
4. Needle thread guide
5. Presser foot bar and presser foot ankle
6. Presser foot

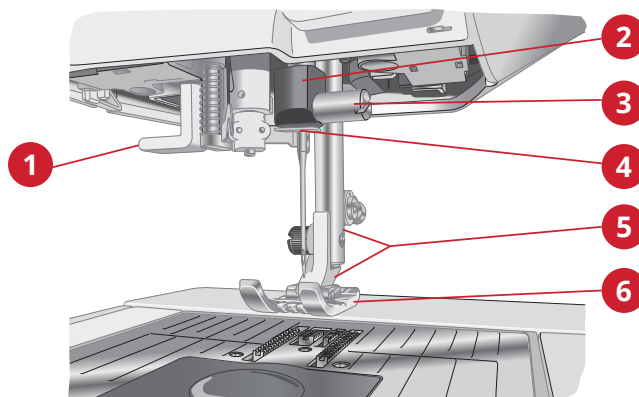

Rear

1. Handle
2. Accessory socket
3. Free arm
4. Embroidery unit socket

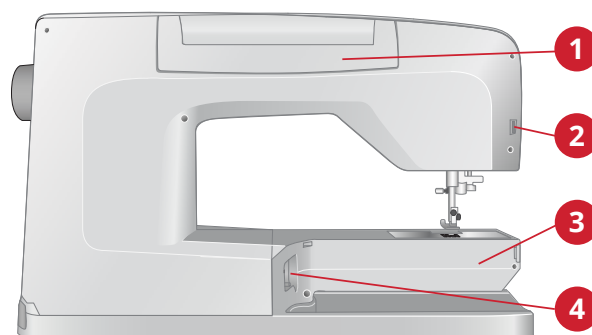

Accessory Tray

The accessory tray features special compartments for presser feet and bobbins, plus space for needles and other accessories. Store the accessories in the tray so that they are easily accessible.

1. Space for accessories
2. Spaces for presser feet
3. Removable bobbin holder
4. Holes for needles

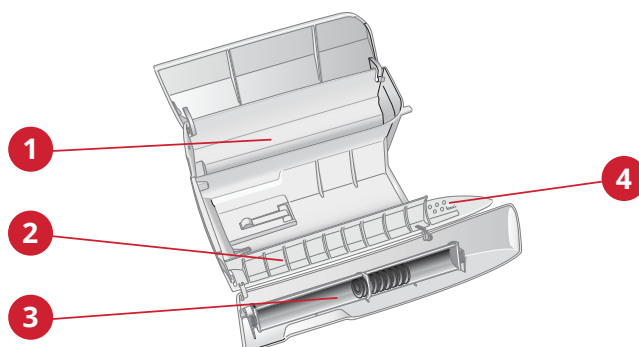

Embroidery Unit

(type BE 17)

1. Embroidery unit release button (underside)
2. Embroidery arm
3. Embroidery hoop attachment
4. Level adjustment feet
5. Embroidery unit plug

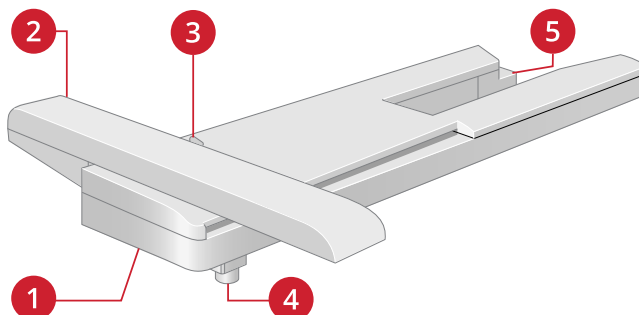

Function Buttons

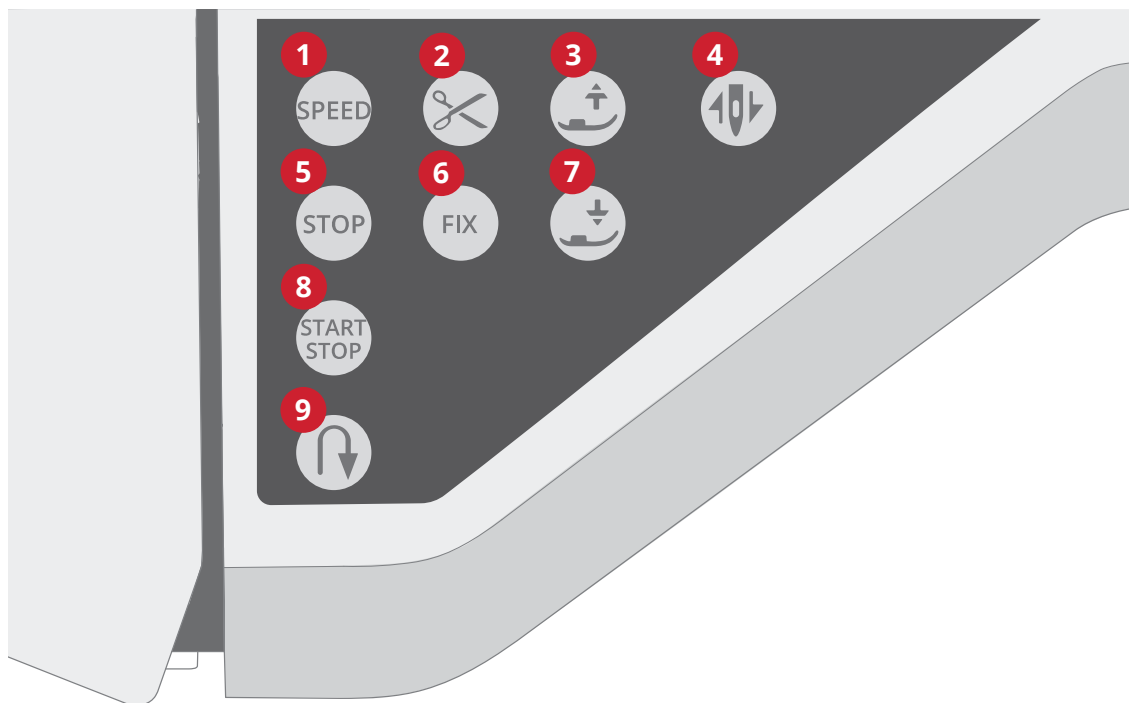

- | | | |
|-----------------------------------|------------------------|--------------------------------|
| 1. Speed | 4. Needle stop up/down | 7. Presser foot down and pivot |
| 2. Selective Thread Cutter | 5. STOP function | 8. Start/stop |
| 3. Presser foot up and extra lift | 6. FIX function | 9. Reverse |

Speed

All stitches and embroideries in your machine have a pre-set, maximum allowed sewing speed to provide a good stitch result.

The machine will never sew faster than the maximum allowed sewing speed for the selected stitch/embroidery. Touch the speed button when the machine is not running and a pop-up on the screen will indicate the speed setting. You can set the speed by touching the slider in the pop-up or by touching the speed button. Each touch of the speed button increases the sewing speed one step. If the machine is set to maximum speed, each touch will instead decrease the sewing speed until minimum speed. Then each touch increases the speed again. If you change the speed setting while sewing no pop-up will appear.

Needle Stop Up/Down

Touch needle stop up/down to set the position of the needle when you stop sewing. The needle will move up or down when you touch the button. When needle stop down is set, a needle icon with an arrow pointing down is shown on the screen.

Tip: You can also tap the foot control to raise or lower the needle once you stop sewing. Tapping the foot control does not change the set stop position.

Cut Function

Touch the cut function button and your machine cuts the upper and bobbin threads, raises the presser foot and needle, and activates the FIX function for the next start.

To cut threads at the end of a stitch or stitch program, touch the cut function button while sewing. A scissor icon will flash on the screen, alerting you that a cut is requested. When the stitch or stitch program is completed, your machine cuts the upper and bobbin threads, raises the presser foot and needle, and activates the FIX function for the next start.

Note: If automatic FIX and selective presser foot lift has been deselected in temporary sewing settings, FIX function will not be activated and presser foot will not be raised when using the cut function.

Touch the cut function button when embroidering and your machine cuts the upper and bobbin threads instantly.



Some optional accessories are attached in the two small circular holes in the needle plate just above the bobbin cover. Do not use the cut function when an accessory is attached in these holes as that may interfere with the automatic thread cutter located under the needle plate.

Reverse

When reverse is active, the reverse indicator is lit. For permanent reverse, touch the reverse button once before starting to sew. The reverse indicator will be lit and the machine sews in reverse until you touch the button again to

cancel. If you press the reverse button while sewing, the machine will sew in reverse for as long as you keep the button pressed.

Reverse is also used when sewing for example manual buttonholes, darning stitches and tapering stitches to step between the parts of the stitch.

START/STOP

Touch the START/STOP button to start and stop the machine sewing or embroidering without using the foot control. Touch START/STOP to begin and touch again to stop.

FIX function

FIX is used to tie off a stitch. Touch the button to turn the function on/off. The indicator next to the FIX function button is lit when the FIX function is active. When beginning to sew with FIX function active, your machine sews a few tie-off stitches and continues with the selected stitch. Touch FIX while sewing and your machine sews a few tie-off stitches and stops automatically.

You can activate automatic FIX in settings, see Automatic FIX.

STOP function

Touch STOP when sewing to conclude a stitch or stitch program. Your machine fixes the thread and stops automatically when the stitch or stitch program has been

completed. Touch STOP before starting to sew and your machine sews only one repetition of the stitch. Only one stitch is displayed on the screen. The indicator next to the STOP button is lit when the STOP function is active. To cancel the function, touch STOP again or select a new stitch. The STOP function is cancelled when the stitch is completed.

The STOP function is also used to repeat a sewn length when sewing tapering, (see Tapering Stitches – Menu Q) and when sewing manual buttonholes.

Presser Foot Down and Pivot

The presser foot is lowered automatically when you start sewing. To lower the presser foot before starting to sew, touch the presser foot down and pivot button. The presser foot will be completely lowered and the machine firmly holds the fabric. Touch presser foot down again to go to pivot position.

In embroidery mode touch presser foot down to lower the presser foot to embroidery position.

Presser Foot Up and Extra Lift

Touch the presser foot up button once to raise the presser foot. Touch again and the presser foot will raise to extra lift position, and the feed teeth will be automatically lowered to make it easier to get heavy fabric under the presser foot.

In embroidery mode, the extra lift makes it easier to insert or remove the hoop.

Accessories

Included Accessories

1. Thread net (2)
2. Screwdriver
3. Seam ripper
4. Brush
5. Bobbins (11)
6. Edge/Quilting guides (used attached to presser foot ankle or together with the Interchangeable Dual Feed Foot)
7. Multipurpose tool/Button reed
8. Hoop clips (16)
9. Spool cap, small (1)
10. Spool cap, medium (1)
11. Spool cap, large (2)
12. Felt pad (2)
13. Straight Stitch Plate

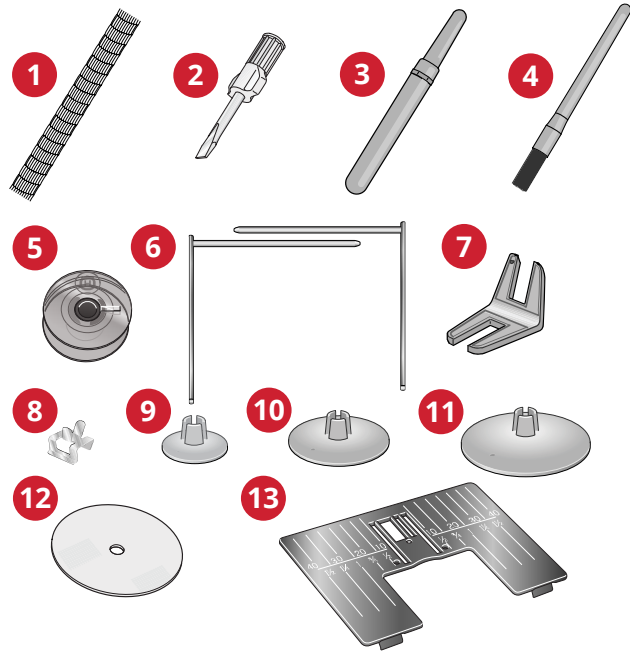

Included Accessories Not in Picture

- Complimentary software (PC and MAC) to download, see Complimentary Software (PC and MAC).
- Hard cover for machine
- Luggage style carrying bag with packing insert for embroidery unit
- Foot control
- Power cord
- Needles
- DESIGNER SAPPHIRE™ 85 Sampler book
- Scissors
- Pieces of fabric and stabilizer
- Microfiber cloth

Included Hoops

1. DESIGNER™ Royal Hoop (360x200)
2. DESIGNER™ Crown Hoop (260x200)
3. DESIGNER™ Splendid Square Hoop (120x120)

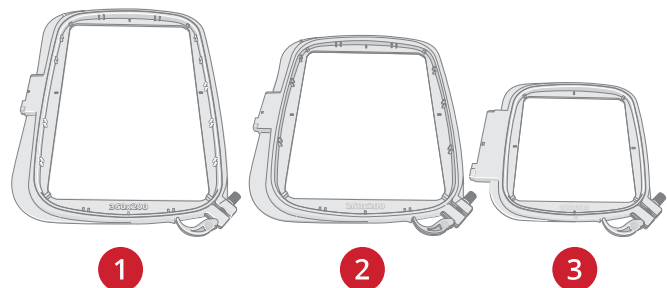

Presser Feet

Note: For the best sewing results, use only presser feet designed for and compatible with your DESIGNER SAPPHIRE™ 85 machine.

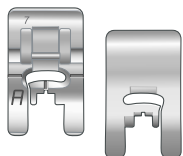

Utility Foot A

Snapped onto the machine upon delivery. Used mainly for straight stitching and zigzag stitching with a stitch length longer than 1.0mm.

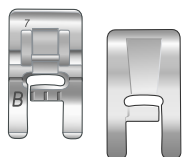

Decorative Stitch Foot B

For sewing close zigzag stitches (satin stitches) with less than 1.0mm stitch length, other utility stitches or decorative stitches, use this foot. The tunnel on the underside of the foot is designed to feed smoothly over the stitches.

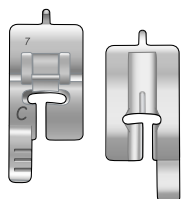

Buttonhole Foot C

For manual buttonholes. This foot has guidelines to determine buttonhole length. The middle measures 5/8" (15mm) from the fabric edge. The two tunnels on the underside of the foot ensure smooth feeding over the buttonhole columns. The finger on the back of the foot holds cording for corded buttonholes.

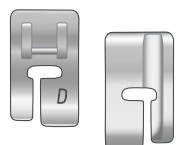

Blindhem Foot D

For blindhem stitches. The inner edge of this foot guides the fabric. The right toe of the foot is designed to ride along the hem edge.

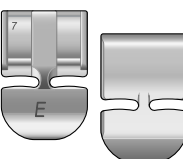

Zipper Foot E

This foot can be snapped on either to the right or to the left of the needle. This makes it easy to sew both sides of the zipper. Move needle position to right or left to sew closer to zipper teeth or for covering large cording.

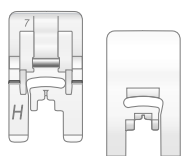

Non-Stick Glide Foot H

This foot, with a non-stick coating underneath, is used when sewing foam, vinyl, plastic, or leather to keep these materials from sticking to the foot.

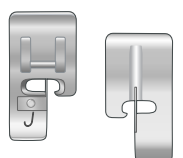

Edging Foot J

Used for overcasting and seam/overcasting, with stitches that have a stitch width of 5.0 and 5.5mm. Stitches form over the pin which prevents puckering at the edge of the fabric.

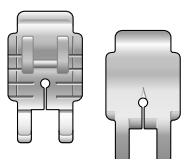

Quilter's 1/4" Piecing Foot P

Used when piecing quilt blocks. The foot has distance guideline marks 1/4" (6mm) and 1/8" (3mm) from the needle.

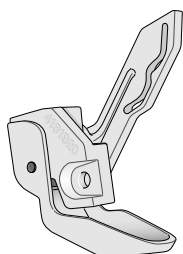

Sensor Q-Foot

The Sensor Q-Foot is recommended for hoop embroidery.

This foot is also used for free motion sewing, free motion quilting and free motion embroidering. When using the Sensor Q-Foot for free motion, select free motion spring action in the free motion options pop-up in sewing mode.

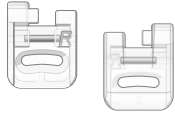

Embroidery/Darning Foot R

Used for free motion embroidery, free motion quilting, free motion stitching and free motion darning. When using this foot, select free motion floating in the free motion options pop-up in sewing mode.

This foot can also be used for hoop embroidery.

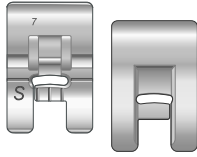

Side-Motion Foot S

Used for side-motion/omnimotion stitches.

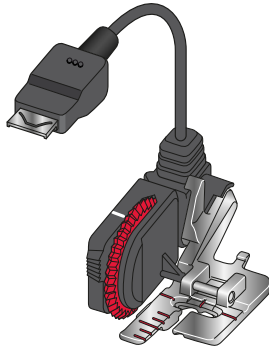

Sensor One-Step Buttonhole Foot

Plug into the machine then enter the desired buttonhole length to sew sensor one-step buttonholes. The middle mark measures a $\frac{5}{8}$ " (15mm) from fabric edge.

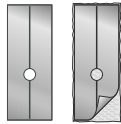

Self-Adhesive Glide Plates

If sewing on foam, vinyl, plastic, or leather, the material can stick to the foot and prevent the sewing machine from feeding properly. When using any of the above materials, sew on a piece of scrap fabric, to make sure the machine feeds smoothly. If not, fasten the self-adhesive glide plate to the underside of the presser foot.

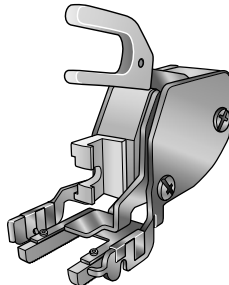





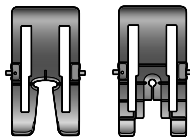













Interchangeable Dual Feed



















The Interchangeable Dual Feed Foot with changeable presser feet is designed to feed layers of fabric and/or batting evenly. It is perfect for quilting, sewing velvet, stretch fabrics, imitation leathers and fabrics that need precise pattern matching. Snap on the Changeable Straight Stitch Foot when using the straight stitch in the center needle position with a stitch length up to 6mm. Snap on the Changeable Zigzag Foot when selecting stitches up to 7mm wide and 6mm long.























Stitch Overview

Utility Stitches

| Stitch | Nº | Presser foot | Name | Description |
|---|-----|--------------|--|--|
|  | A1 | A | Straight stitch, left needle position | For all types of sewing. |
|  | A2 | A | Straight stitch, center needle position | For all types of sewing. |
|  | A3 | A | Straight stitch, right needle position | For all types of sewing. |
|  | A4 | A | Straight stitch with reinforced tie-off | For all types of sewing. Begins and ends with forward and reverse stitches. |
|  | A5 | A | Stretch stitch, left needle position | For seams in tricot and stretch fabrics. |
|  | A6 | A | Stretch stitch, center needle position | For seams in tricot and stretch fabrics. |
|  | A7 | A | Stretch stitch, right needle position | For seams in tricot and stretch fabrics. |
|  | A8 | B | Zigzag, left needle position | For sewing on lace, trims and appliqués. |
|  | A9 | B | Zigzag, center needle position | For sewing on lace, trims and appliqués. |
|  | A10 | B | Zigzag, right needle position | For sewing on lace, trims and appliqués. |
|  | A11 | A | Reinforced straight stitch, left needle position | Triple and elastic, for reinforced seams. For top stitch, increase the stitch length. |
|  | A12 | A | Reinforced straight stitch, center needle position | Triple and elastic, for reinforced seams. For top stitch, increase the stitch length. |
|  | A13 | A | Reinforced straight stitch, right needle position | Triple and elastic, for reinforced seams. For top stitch, increase the stitch length. |
|  | A14 | A | Reinforced zigzag stitch | For joining fabric edge to edge or overlapping in leather. For decorative sewing. |
|  | A15 | A | Three-step zigzag | For overcasting, mending, sewing on patches and elastic. Suitable for light and medium weight fabrics. |
|  | A16 | J | Seam/overcast stitch | Seam and overcast in one step along the edge or trim later. For light stretch and non-stretch fabrics. |
|  | A17 | B | Stretch seam/overcast stitch | Seam and overcast in one step along the edge or trim later. For medium and heavy stretch fabrics. |
|  | A18 | B | Double overlock stitch | Seam and overcast in one step along the edge or trim later. For heavy stretch and heavy woven fabrics. |
|  | A19 | B | Overlock stitch | Seam and overcast in one step along the edge or trim later. For medium stretch fabrics. |

| Stitch | № | Presser foot | Name | Description |
|---|-----|--------------|---------------------------------------|--|
|  | A20 | B | Flatlock stitch | Decorative hems and overlapped seams, belts and bands. For medium/heavy stretch fabrics. |
|  | A21 | D | Stretch blind hem stitch | Blind hems in medium and heavy stretch fabrics. |
|  | A22 | D | Woven blind hem stitch | Blind hems in medium and heavy woven fabrics. |
|  | A23 | A | Shell edge stitch | For edging, sewing over the edge on light woven fabrics. Sew woven fabrics on bias. |
|  | A24 | A | Four-step zigzag | For overcasting, mending, sewing on patches and elastics on loosely woven fabrics. |
|  | A25 | B | Elastic/casing stitch | For overlapped seams in tricot. To sew casing over narrow elastic. |
|  | A26 | A | Serpentine stitch | For mending and elastic applications. |
|  | A27 | B | Elastic or smocking stitch | Sew over two rows of elastic thread for elastic shirring. |
|  | A28 | B | Bridging stitch | For joining two pieces of fabric with finished edges and for elastic shirring. |
|  | A29 | J | Three-step zigzag | For overcasting, mending, sewing on patches and elastic. Suitable for light and medium weight fabrics. |
|  | A30 | A | Two-step zigzag | For joining two pieces of lace, and for elastic shirring. |
|  | A31 | B | Bartack | Reinforce pockets, shirt openings, belt loops as well as at lower end of a zipper. |
|  | A32 | B | Bartack, manual | Reinforce pockets, shirt openings, belt loops as well as at lower end of a zipper. |
|  | A33 | A | Darning stitch (forward and backward) | Darn and mend small holes in work clothes, jeans, tablecloths and linen towels. Stitch over hole, touch reverse for continuous darning and auto stop. |
|  | A34 | A | Darning stitch (side to side) | For mending small tears. |
|  | A35 | A | Reinforced darning stitch | Darn and mend work clothes, jeans, tablecloths and linen towels. Stitch over hole, touch reverse for continuous darning and auto stop. |
|  | A36 | B | Darning stitch (four-step) | A group of four stitches perfect for mending small tears. Stitch #1 and #3 are sewn in a forward motion, stitch #2 and #4 are sewn backwards. To change stitch and direction touch the reverse button. <i>Tip: Press fusible interfacing on the wrong side before mending the tear.</i> |
|  | A37 | A | Belt loop stitch | For securing belt loops. |
|  | A38 | A | Basting stitch | For temporary seams. The long stitches and reduced tension make the seams easy to unravel. |

| Stitch | № | Presser foot | Name | Description |
|---|-----|--------------------------|---|---|
|  | A39 | A | Straight basting stitch | To baste, press the foot control and the machine will make two stitches, stop and raise the foot. When the presser foot lifts, move the fabric to the next baste position and press the foot control. Feed teeth lowered automatically. |
|  | A40 | A | Zigzag basting | To baste, press the foot control and the machine will make two stitches, stop and raise the foot. When the presser foot lifts, move the fabric to the next baste position and press the foot control. Feed teeth lowered automatically. |
|  | A41 | A | Gathering stitch | No fix stitch in the beginning of the seam for easy gathering. |
|  | A42 | Sensor Buttonhole foot/C | Wide bartack buttonhole | For medium and heavy fabrics with extra cutting space. |
|  | A43 | Sensor Buttonhole foot/C | Bartack buttonhole | For most fabric weights. |
|  | A44 | Sensor Buttonhole foot/C | Rounded bartack buttonhole | For light weight fabrics. |
|  | A45 | Sensor Buttonhole foot/C | Round end buttonhole | For blouses and children's garments. |
|  | A46 | Sensor Buttonhole foot/C | Keyhole buttonhole | Square end for tailored jackets, coats, etc. |
|  | A47 | Sensor Buttonhole foot/C | Tapered keyhole buttonhole | Tapered end for tailored garments. |
|  | A48 | Sensor Buttonhole foot/C | Decorative fashion buttonhole | For most fabric weights. |
|  | A49 | Sensor Buttonhole foot/C | Heavy duty buttonhole | With reinforced bartacks |
|  | A50 | Sensor Buttonhole foot/C | Heavy reinforced buttonhole | For utility and heavy fabrics. |
|  | A51 | Sensor Buttonhole foot/C | Medium Reinforced Buttonhole | For medium and heavy fabrics. |
|  | A52 | C | Medium reinforced decorative buttonhole | For medium fabrics. |
|  | A53 | Sensor Buttonhole foot/C | Heirloom buttonhole | For hand look on fine and delicate fabrics. <i>Tip: For jeans buttonholes, increase length and width of the buttonhole. Use thicker thread.</i> |
|  | A54 | Sensor Buttonhole foot/C | Rounded heirloom buttonhole | For hand look on fine and delicate fabrics. |

| Stitch | № | Presser foot | Name | Description |
|---|-----|--------------|---|---|
|  | A55 | A | Leather buttonhole (straight stitch) | For leather and suede. |
|  | A56 | A | Bound buttonhole (straight stitch) | With extra cutting space for bound buttonholes. |
|  | A57 | - | Automatic button sewing | For sewing on buttons. |
|  | A58 | B | Round eyelet | For belts, laces, etc. |
|  | A59 | B | Teardrop eyelet | For laces, embellishments. |

Stitch Menu Overview

There are several different stitch menus with stitches for all purposes. For detailed description of a stitch, use the quick help function, see Quick Help.

| Stitch Menu Name | Description |
|----------------------------------|--|
| A — Utility Stitches | Stitches for garment sewing and mending. |
| B — Appliqué Stitches | For sewing appliqués with different effects. |
| C — Heirloom Stitches | Decorative stitches for traditional heirloom sewing. Stitches for hemstitching, smocking and sewing on laces and trims. |
| D — Quilt Stitches | Stitches for all types of quilting techniques. |
| E — Crafting Stitches | Decorative stitches to embellish crafts. |
| F — Decorative Stitches | For decorative sewing. |
| G — Vintage Stitches | A selection of quilt stitches for crazy patch quilting and decorative stitching. |
| H — Children Stitches | Stitches suitable for sewing on children's clothes and projects. |
| J — Scallop Stitches | Create scallop details and finish edges with beautiful scallop stitches. |
| K — Omnimotion Stitches | Program these stitches into an unlimited number of combinations. Stitches are formed with side motion. The stitch width can be up to 49mm wide. |
| L — Dimensional Stitches | Includes three types of stitches: appliqué and pop-up stitches, combinations of these two types, and sequin stitches. |
| M — Theme Stitches | Each stitch number on this menu contains a group of four stitches designed to be sewn out together in random combinations. Change to the next stitch in the selected group by touching the reverse button. |
| N — Embellished Stitches | Decorative stitches that can be used as they are, or further embellished after sewing. Use quick help for detailed information. |
| O — Single Motif Stitches | Single stitches for embellishment. The machine stops after one sewn repetition. |
| P — Specialty Stitches | Sew special techniques including candlewicking, edging and more. Extra accessories may be needed. Use quick help for detailed information. |
| Q — Decorative Tapering Stitches | Decorative stitches with tapering. |
| R — Pictogram Stitches | Pictogram satin elements to program original satin stitch designs. |
| S — 4-Way Stitches | Four directional sewing and patching using the free arm. |
| T — 8-Way Stitches | Straight stitch and reinforced straight stitch in eight different directions without turning the fabric. Can be programmed with decorative stitches to create unique borders. |

Alphabets

Stitch fonts are available in block, outline, brush line, script and Cyrillic alphabets.

Basic Gestures for the Multi-Touch Screen

Easily navigate on the multi-touch screen with the gestures described below.

1. *Touch* — Touch once on a button or setting on the screen to select.
2. *Touch & Hold* — Touch once without releasing for a few seconds to touch & hold. Used on some buttons and screen areas to access more options.
3. *Pinch/Stretch* — Touch with two fingers at the same time and without releasing increase/decrease the distance between the fingers to stretch (zoom in) or pinch (zoom out).
4. *Touch and Move* — Touch once on a selected design and, without releasing, move your finger to a different position on the screen. Used e.g. for moving a design in the embroidery area.
5. *Swipe* — Touch, move and release your finger in a swift gesture to swipe. Left-right/right-left swipe is used e.g. to scroll between stitch menus. Top-bottom/bottom-top swipe is used e.g. to scroll within a stitch menu.

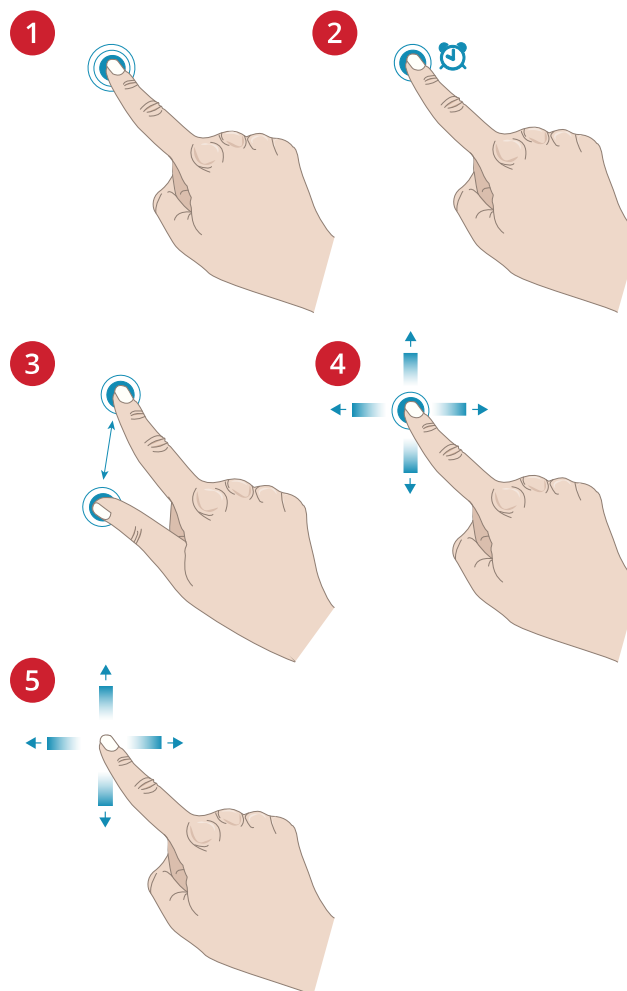

Smart Toolbox

Smart toolbox is available on a stitch or program in the sewing area or on a design, stitch or program in the embroidery area. Touch & hold on a stitch program or design to open the smart toolbox, move your finger to highlight the option you want to use and release to select the option.

The options included in the smart toolbox varies depending on where and on what it is used. Examples of options are duplicate, delete, mirroring and edit.

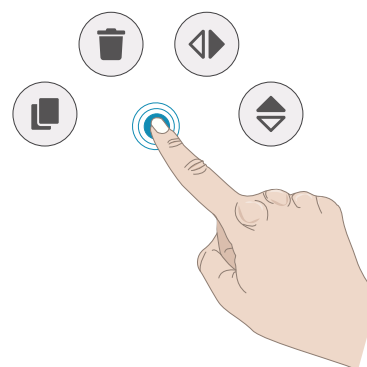

2 Preparations

Unpacking Machine and Embroidery Unit

After lifting the machine out of the box and removing all packing material and the plastic bag, wipe the machine, particularly around the needle and needle plate to remove any oil before sewing.

When unpacking the embroidery unit, do not throw away the black styrofoam inside the embroidery unit carrying bag, as this is designed for storing the embroidery unit when not in use.

Note: Your DESIGNER SAPPHIRE™ 85 machine is adjusted to provide the best stitch result at normal room temperature. Extreme hot and cold temperatures can affect the sewn result.

Connect the Power Cord and Foot Control

Among the accessories you will find the power cord and the foot control.

Note: Before plugging in the foot control, check to ensure that it is type "FR5" (see underside of foot control).

1. Pull out the cord from the foot control. Connect the foot control cord to the front socket on the bottom right side of the machine.
2. Connect the power cord to the rear socket on the bottom right side of the machine. Plug the cord into the wall socket.
3. Press the ON/OFF switch to "I" to turn on power and light.

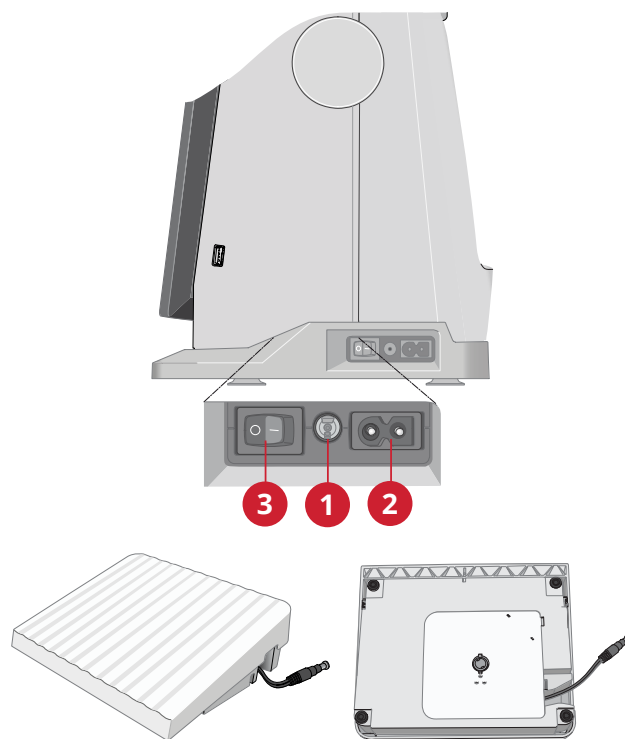

For the USA and Canada

This sewing machine has a polarized plug (one blade wider than the other). To reduce the risk of electric shock, this plug is intended to fit in a polarized outlet only one way. If the plug does not fit fully in the outlet, reverse the plug. If it still does not fit, contact a qualified electrician to install the proper outlet. Do not modify the plug in any way.

Pack Away After Sewing

1. Press the ON/OFF switch to "O".
2. Unplug the cord from the wall socket and then from the machine.
3. Unplug the foot control cord from the machine. Pull the cord gently and release. The cord will retract into the foot control.
4. Place all accessories in the accessory tray. Slide the tray on to the machine around the free arm.
5. Place the foot control in the space above the free arm.
6. Put on the hard cover.

Tip: The user's guide and power cord can be stored in the back pocket of the hard cover.

USB Port

Your machine has a USB port for connecting USB devices such as a memory stick. USB plugs can only be inserted one way – do not force them into the port! To remove, carefully pull the USB device straight out.

Note: Make sure that the USB stick you use has the format FAT32.

Using a USB device

The external device button in file manager is only active when a device is connected to the machine USB port.

Note: Do not remove the USB device if a loading spinner is shown on the screen or while the file manager is shown. Removing the device at that time can damage the files on your USB device.

Read more in File Manager – Overview.

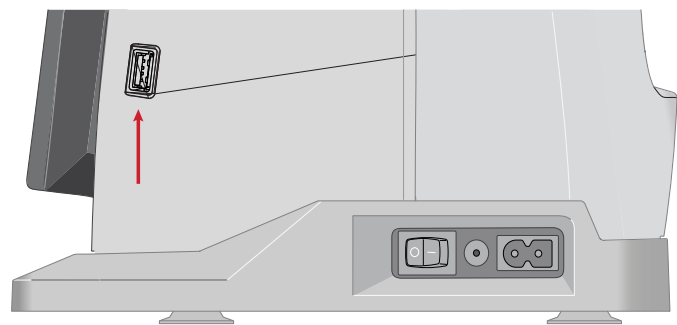

Getting Started with WiFi and mySewnet™ Cloud

Follow the steps below to connect your machine.

Connect to a Network with WiFi

Touch the WiFi button in the top left corner of the screen. Select from the list of available networks. If your network is password protected, you will be prompted to enter the password to connect.

For more information, see WiFi Introduction.



WiFi button

Connect to mySewnet™ Cloud

When you have established a WiFi connection, touch the cloud button next to the WiFi button on the screen. Touch the button to sign in. A web view opens where you can log in. If you do not have a user name and password, select Register to create an account.

For more information, see *mySewnet™* Cloud.



mySewnet™ cloud button

LED Lights

Your machine has LED lights which distribute the light evenly over the sewing area and eliminate shadows. You can adjust the brightness of the light in the settings menu, see LED Work Light Brightness .

Free Arm

To use the free arm, slide off the accessory tray. When attached, a hook keeps the accessory tray locked to the machine. Remove the tray by sliding it to the left.

Manual Thread Cutter

There are three manual thread cutters on your machine.

- The first one (A) is close to the bobbin winder spindle for cutting the thread before and after winding.
- The second one (B) is on the left side of the machine for manually cutting top and bobbin threads. Pull both threads into the cutter from the back to the front and pull down quickly.
- The third one (C) is next to the bobbin area for cutting the bobbin thread after placing the bobbin in the machine.

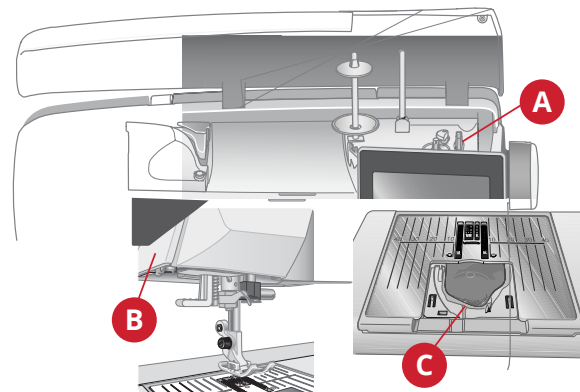

Thread Sensor

- If the needle thread breaks or bobbin thread is running low, the machine stops and a pop-up appears on the screen. If needle thread breaks: Remove the thread completely, re-thread the machine and touch OK in the pop-up.
- If bobbin thread is running low: You can continue sewing without closing the pop-up before the bobbin thread runs out completely. This gives you an opportunity to plan where to stop and change the bobbin. When the bobbin is replaced with a full one, touch OK in the pop-up.

Spool Pins

Your machine has two spool pins; a main spool pin and an auxiliary spool pin.

The spool pins are designed for all types of thread. The main spool pin is adjustable and can be used both in a horizontal position (the thread reels off the spool) and a vertical position (the thread spool rotates). Use the horizontal position for regular sewing threads and the vertical position for large spools or specialty threads.

Horizontal Position

Place a spool cap and the thread spool on the spool pin. Make sure that the thread reels off the spool counter clockwise and slide on a second spool cap.

Note: Not all thread spools are manufactured in the same way. If you experience problems with the thread, turn it in the opposite way or use the vertical position.

Use a spool cap slightly larger than the thread spool. For narrow thread spools, use a smaller spool cap in front of the spool. For large thread spools, use a larger spool cap in front of the spool.

The flat side of the spool cap should be pressed firmly against the spool. There should be no space between the spool cap and the thread spool.

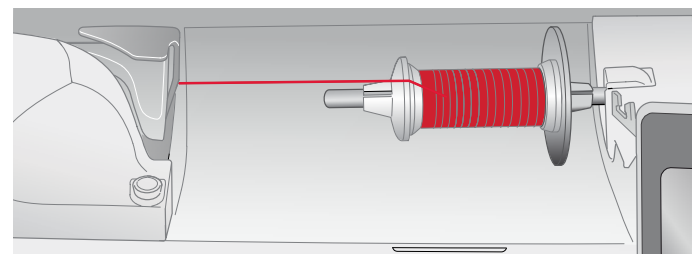
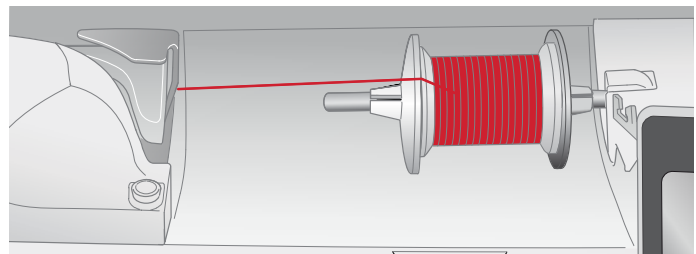

Vertical Position

Raise the spool pin to the vertical position. Slide on the large spool cap. For spools smaller than the medium size spool cap, place a felt pad under the thread spool to prevent the thread from reeling off too fast. Place thread spool on the spool pin.

Note: Do not place a spool cap on top of the vertical spool pin as it may prevent the spool from rotating.

Note: Push down the spool pin until it locks in place. This will prevent the spool pin from being folded down while sewing. To place it in horizontal position, pull the spool pin up and then fold it.

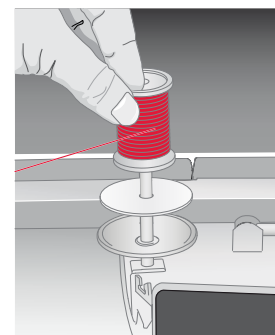

Auxiliary Spool Pin

The auxiliary spool pin is used when winding a bobbin from a second spool of thread or for a second spool when sewing with a twin needle.

Raise the auxiliary spool pin. Slide on a large spool cap and place a felt pad under the thread spool. Place thread spool on auxiliary spool pin.

Note: When sewing with two needle threads, deactivate deLuxe™ Stitch System.

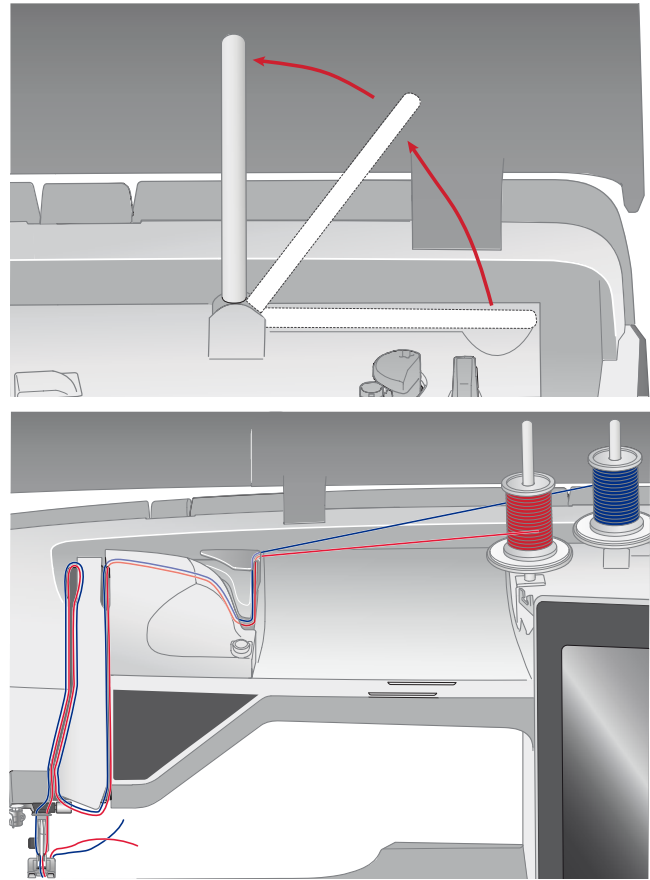

Threads

There are many threads on the market today developed for different purposes.

All Purpose Sewing Thread

All purpose sewing thread is made of synthetic, cotton or cotton covered polyester. This type of thread is used for most sewing projects, including garments, home decor, and quilting.

Embroidery Thread

Embroidery thread is made from a variety of fibers: rayon, polyester, acrylic or metallic. These threads create a smooth glossy appearance for embroidery and other decorative stitching.

Embroidery thread is not typically used in the bobbin unless both sides of the project will be seen. A light weight, embroidery bobbin thread is often used in the bobbin instead. The lighter weight thread does not build up under the embroidery.

Note: When using a metallic or a flat film thread for embroidery, you may need to use a needle with a larger eye and lower the embroidery speed.

Transparent Thread

Transparent thread, also called monofilament thread, is a single clear synthetic thread. It is used for quilting and other decorative sewing. When winding a bobbin, wind at half speed and fill the bobbin half full.

Needles

The sewing machine needle plays an important role in successful sewing. Use only quality needles. We recommend needles of system 130/705H. The needle package included with your machine contains needles of the most frequently used sizes.



*Be sure to match the needle to the thread you are using.
Heavier threads require a needle with a larger needle eye.*

Universal Needle

Universal needles have a slightly rounded point and come in a variety of sizes. For general sewing in a variety of fabric types and weights.



Stretch Needle

Stretch needles have a special scarf to eliminate skipped stitches when there is a flex in the fabric. For knits, swimwear, fleece, synthetic suedes and leathers.



Embroidery Needle

Embroidery needles have a special scarf, a slightly rounded point and a slightly larger eye to avoid damage to thread and materials. Use with metallic and other specialty threads for embroidery and decorative sewing.



Denim Needle

Denim needles have a sharp point to penetrate tightly woven fabrics without deflecting the needle. For canvas, denim, microfibers.



Wing Needle

Wing needles have wide wings on the side of the needle to poke holes in the fabric when sewing entredeux and other hemstitches on natural fiber fabrics.



Important Needle Information

Change the needle often. Always use a straight needle with a sharp point (A).

A damaged needle (B) can cause skipped stitches, breakage or snapping of the thread. It can also damage the needle plate.

Do not use asymmetrical twin needles (C), they can damage your sewing machine.

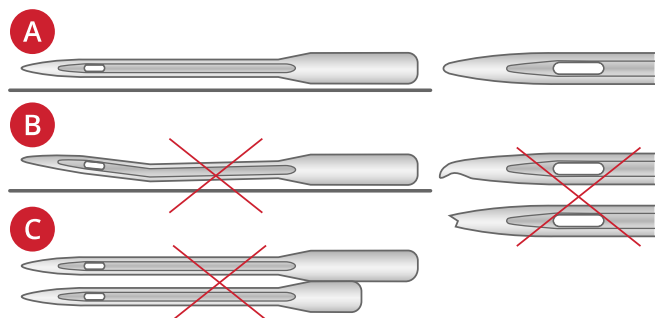

Changing the Needle

1. Use the hole in the multipurpose tool to hold the needle.
2. Loosen the needle screw with the screwdriver.
3. Remove the needle.
4. Insert the new needle using the multipurpose tool. Push the new needle upwards with the flat side away from you until it will go no further.
5. Tighten the needle screw with the screwdriver.

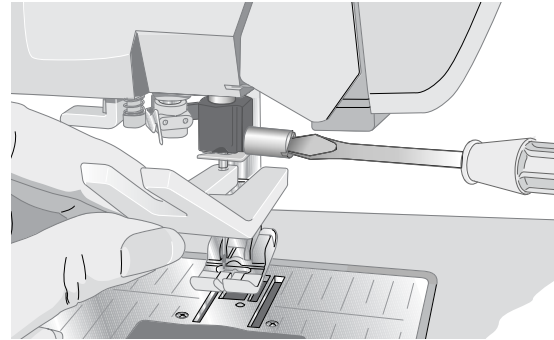

Threading the Upper Thread

Make sure that the presser foot is raised and the needle is in the up position.

Horizontal Spool Pin

1. Hold the thread near the spool using your right hand.
2. Use your left hand to bring the end of the thread over and behind the Pre-Tension Thread guide (A) and under the thread guide (B). Bring the thread between the thread tension discs (C).
3. Continue threading in the direction indicated by the arrows. Bring the thread from the right when threading into the slot on the take-up lever (D).
4. Take the thread down into the last thread guide (E) just above the needle.

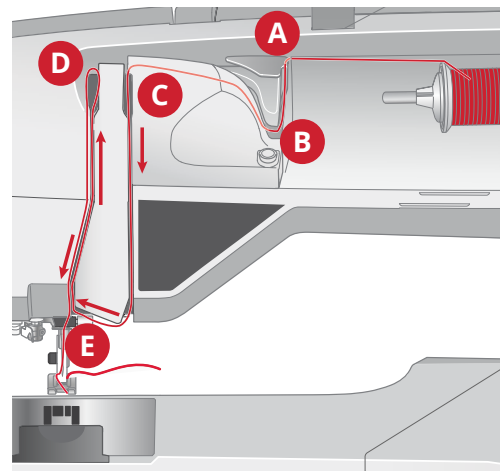

Needle threader

The needle threader allows you to thread the needle automatically. The needle must be in the up position to use the built-in needle threader.

1. Lower the presser foot.
2. Use the handle to pull the needle threader all the way down. The threader hook (A) swivels through the needle eye.
3. Place the thread from the back over the hook (B) and under the thread hook (A).
4. Let the needle threader gently swing back. The hook pulls the thread through the needle eye and forms a loop behind the needle. Pull the thread loop out behind the needle.

Note: The needle threader is designed to be used for size 70-120 needles. You cannot use the needle threader for needles size 60 or smaller, the wing needle, twin needle, triple needle or when the Sensor One-Step buttonhole foot is attached. There are also some optional accessories that require manual threading of the needle.

When threading the needle manually, make sure that the needle is threaded from front to back. The bobbin cover can be used as a magnifying glass to make threading easier.

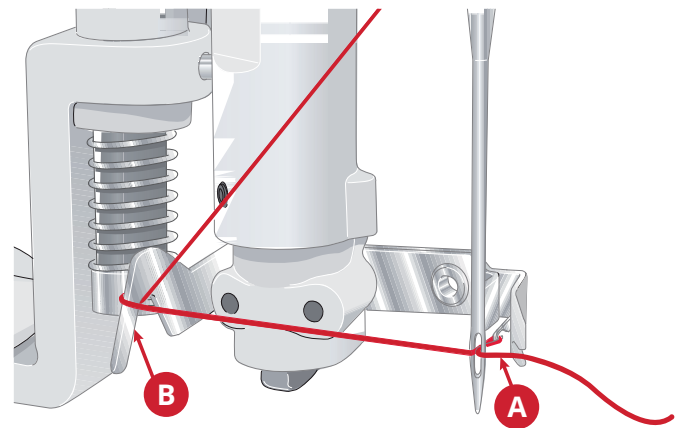
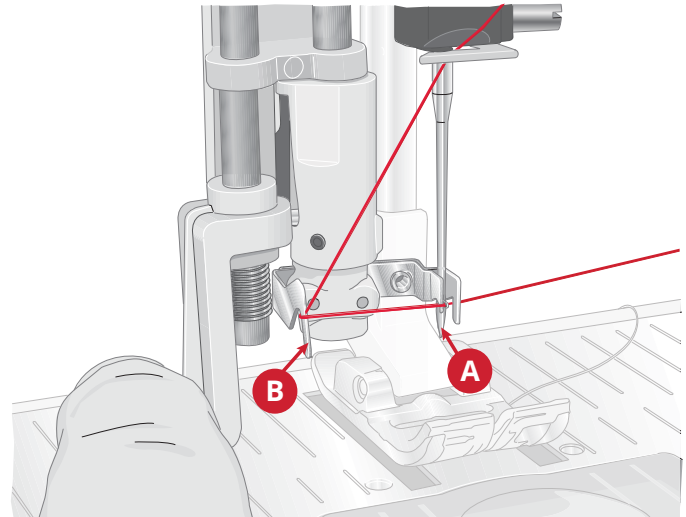

Selecting Correct Thread/Needle Combination

| Fabric | | Thread | Needle |
|----------------|---|--|---|
| Woven light | Chiffon, organza, batiste, challis, crepe de chine, etc. | Light weight threads: <ul style="list-style-type: none"> • fine cotton, polyester or silk sewing thread • rayon embroidery thread | Universal 130/705H 70/10-80/12 |
| Woven medium | Calico, quilting fabrics, crepe, broadcloth, velvet, etc. | Medium weight threads: <ul style="list-style-type: none"> • fine/normal cotton or polyester sewing thread • rayon embroidery thread | Universal 130/705H 80/12-90/14 |
| Woven heavy | Denim, tweed, canvas, terrycloth, etc. | Medium/heavy weight threads: <ul style="list-style-type: none"> • normal cotton or polyester sewing thread • top stitching thread • rayon embroidery thread | Universal 130/705H 90/14-110/18 Denim 130/705H-J 90/14 |
| Stretch light | Tricot, single knit jerseys, etc. | Light weight threads: <ul style="list-style-type: none"> • fine cotton or polyester sewing thread • rayon embroidery thread | Stretch 130/705H-S 75/11 |
| Stretch medium | Sweater knits, double knit, velour, swimwear, etc. | Medium weight threads: <ul style="list-style-type: none"> • normal cotton or polyester sewing thread • rayon embroidery thread | Stretch 130/705H-S 90/14 |
| Stretch heavy | Sweater knits, fleece, etc. | Medium weight threads: <ul style="list-style-type: none"> • normal cotton or polyester sewing thread • rayon embroidery thread | Stretch 130/705H-S 90/14 |
| Leather | Suede and leather | Medium weight threads: <ul style="list-style-type: none"> • normal cotton or polyester sewing thread • rayon embroidery thread | Stretch 130/705H-S 90/14 |
| Vinyl | Vinyl, faux leather and suede | Medium weight threads: <ul style="list-style-type: none"> • normal cotton or polyester sewing thread • rayon embroidery thread | Universal 130/705H 80/12 |

Note: Specialty fabrics and threads may require a special needle for best stitch results. Refer to your HUSQVARNA® VIKING® retailer for more information on needle types and sizes for your sewing needs.

Threading for Twin Needle

Replace the sewing needle with a twin needle. Make sure the presser foot is raised and the needle is in the up position.

1. Raise the horizontal spool pin to the vertical position. Raise the auxiliary spool pin to the vertical position. Slide a large spool cap and a felt pad on each one. Place the thread spools on the spool caps.
2. Bring the threads over and behind the Pre-Tension Thread guide (A) and under the thread guide (B). Follow the thread slot and place the thread between the thread tension discs (C). Make sure that one thread is on each side of the tension discs.
3. Thread down through the right-hand threading slot and then upwards through the left-hand threading slot.
4. Bring the threads from the right into the take-up lever (D) and down in the left-hand threading slot. Make sure that one thread is inside the needle thread guide (E) and the other one outside. Also make sure that the threads do not become twisted together.

Note: The weight and irregular surface of specialty threads such as metallic increases the amount of friction on the thread. By reducing the tension, the risk of needle breakage and thread breakage is reduced.

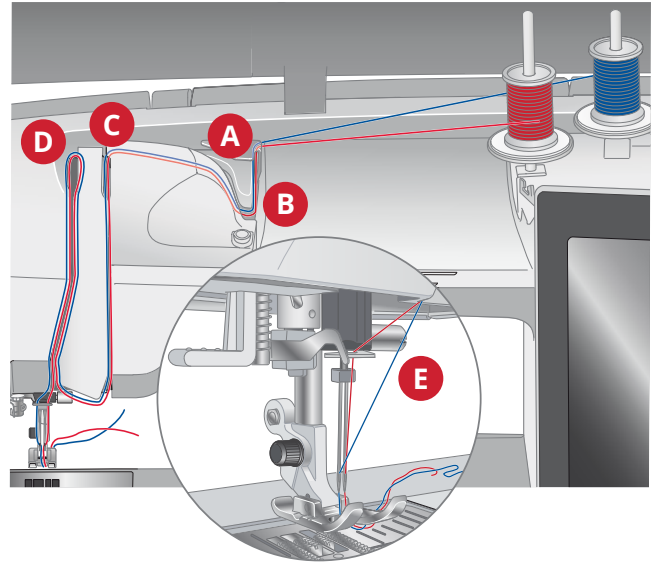

Bobbin Winding

Bobbin Winding through the Needle

Make sure that the presser foot and the needle are in the up position.

1. Place an empty bobbin on the bobbin spindle on the top of the machine. The bobbin only fits on one way, with the logo facing up. Use only original HUSQVARNA® VIKING® bobbins.
2. Thread the machine with the main spool pin in the horizontal position.

Note: If the thread spool is too large to be in horizontal position, wind the bobbin as described under “Winding Specialty Threads” below.

3. Bring the thread up from the needle, under the presser foot and up to the right through thread guide (A).

Note: Use a metal presser foot when bobbin winding from the needle.

4. Guide the thread through the hole in the bobbin from the inside to the outside.

Note: When using earlier version of HUSQVARNA® VIKING® bobbins that do not have a hole, wind a few turns of thread clockwise on the bobbin to get started.

5. Push the bobbin winding lever towards the bobbin to wind. A pop-up message appears on screen. To adjust winding speed drag the slider. Stop and start the bobbin winding with the on-screen buttons. Hold the end of the thread firmly when starting to wind. Once the bobbin begins to wind, cut the excess thread.

Note: It is important that you cut the thread end close to the bobbin.

When the bobbin is full, the bobbin winder lever will move back and the winding will stop automatically. The pop-up message closes. Remove the bobbin and cut the thread using the bobbin winding thread cutter.

Winding Specialty Threads

We do not recommend winding speciality threads such as “invisible” or other stretchy threads, metallic or flat metallic threads through the needle.

Always wind these threads at minimum speed.

1. Place an empty bobbin on the bobbin spindle at the front of the machine. The bobbin only fits on one way, with the logo facing up. Use only original HUSQVARNA® VIKING® bobbins.
2. Place the large spool cap and a felt pad under the spool on the main spool pin set in the vertical position.
3. Bring the thread over the Pre-Tension Thread guide (B) and down around the thread tension disc (C), then through thread guide (D) as illustrated.
4. See Bobbin Winding through the Needle, step 4-5.

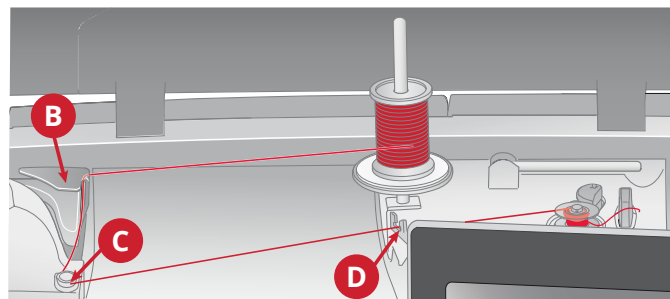
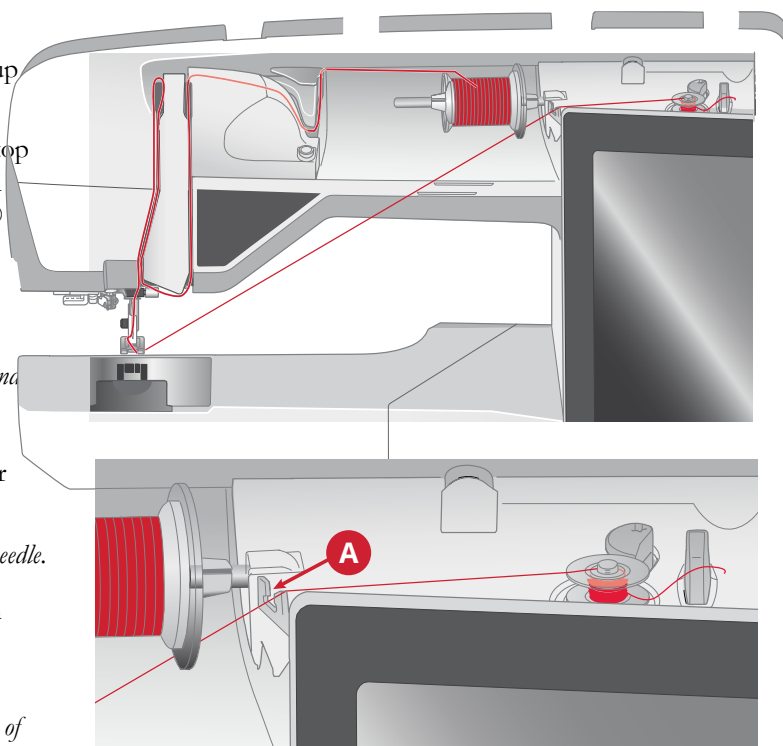

Bobbin Winding while Embroidering or Sewing

1. Raise the auxiliary spool pin. Place the large spool cap, felt pad and thread spool on the spool pin.
2. Bring the bobbin thread around the thread tension disc (A) and through the thread guide (B) as illustrated.
3. Guide the thread through the hole in the bobbin from the inside to the outside.
4. Push the bobbin winder lever towards the bobbin to wind. A pop-up message appears on screen. To adjust winding speed drag the slider with your stylus. Stop and start the bobbin winding with the on-screen buttons. Hold the end of the thread firmly when starting to wind.

When the bobbin is full, the bobbin winder lever will move back and the winding will stop automatically. The pop-up message closes. Remove the bobbin and cut the thread using the bobbin winding thread cutter.

Note: Make sure that the thread does not touch the cap of the horizontal spool pin when winding the bobbin. If it does, place the cap and spool higher on the vertical spool pin.

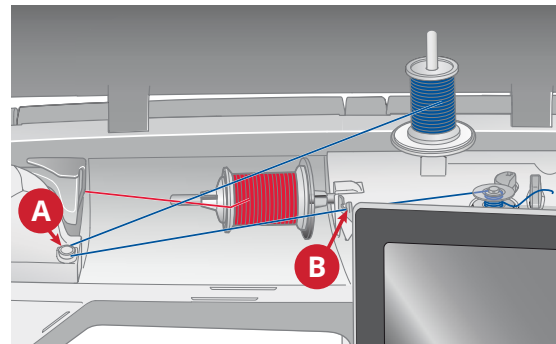

Inserting the Bobbin



Use only the bobbins designed for your DESIGNER SAPPHIRE™ 85 machine.

1. Remove the bobbin cover by sliding it towards you.
2. Place the bobbin in the bobbin case. It drops in only one way with the logo facing up. The thread unreels from the left of the bobbin. The bobbin will then rotate counter-clockwise when you pull the thread.
3. Place your finger on the bobbin to keep it from turning as you pull the thread firmly to the right and then to the left into the tension spring (A) until it “clicks” into place.

Continue threading around (B) and to the right of the thread cutter (C).

4. Slide on the bobbin cover (D). Pull the thread to the left to cut (E).

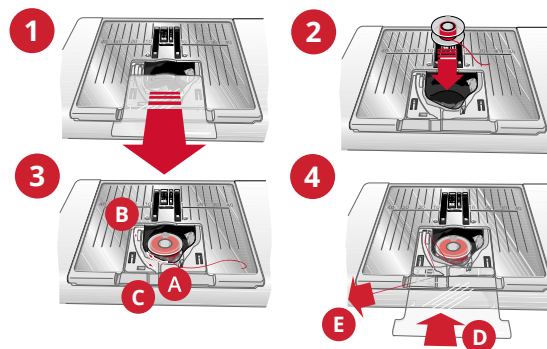

Changing the Presser Foot

1. Make sure that the needle is in the highest position. Pull the presser foot down and towards you.
2. Line up the cross pin on the foot with the gap in the presser foot ankle. Push the foot into the gap until the foot snaps into place.

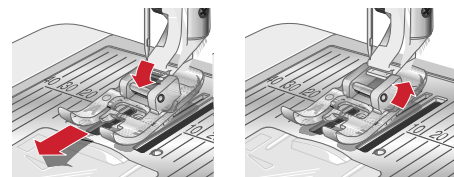

Attaching the Sensor One-Step Buttonhole Foot

1. Snap on the Sensor One-Step Buttonhole Foot.
2. Insert the plug, with the three dots facing out, into the accessory socket at the back of the sewing head.

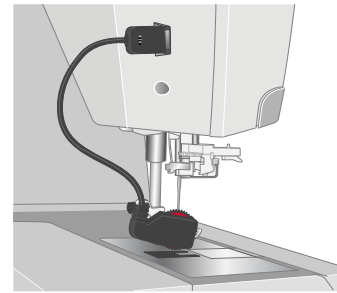

Attaching the Sensor Q-Foot

1. Using the screwdriver, remove the presser foot ankle.
2. Place the Sensor Q-foot from behind, and lower the needle into the opening of the foot by turning the handwheel towards you.

Position the foot onto the presser foot bar so that the hole on the foot matches the hole on the presser foot bar. The arm of the presser foot should rest on top of the needle screw. Insert the screw and tighten the screw with a screwdriver.

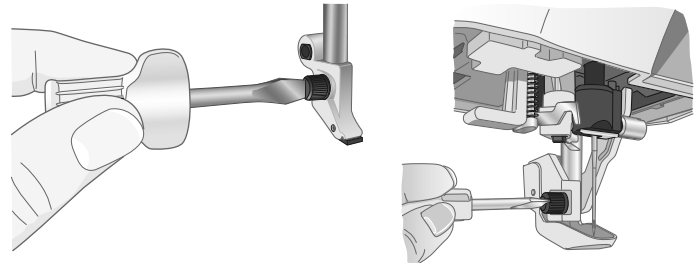

Interchangeable Dual Feed Foot

The Interchangeable Dual Feed Foot is designed to feed layers of fabric and/or batting evenly. It is perfect for quilting, sewing velvet, stretch fabrics, imitation leathers and fabrics that need precise pattern matching. Snap on the Changeable Straight Stitch Foot when using the straight stitch in the center needle position with a stitch length up to 6mm. Snap on the Changeable Zigzag Foot when selecting stitches up to 7mm wide and 6mm long.

1. Dual Feed
2. Changeable Zigzag Foot Plate
3. Changeable Straight Stitch Foot Plate

Note: Look for optional dual feed accessories in the online accessory user's guide at www.husqvarnaviking.com or at your HUSQVARNA® VIKING® retailer.

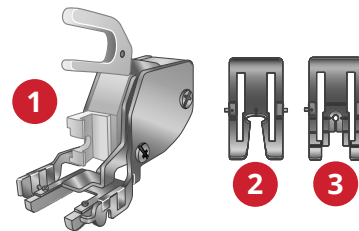

Attaching the Dual Feed

1. Use the screwdriver to remove the presser foot ankle.
2. Place the dual feed on your machine from the back, positioning the fork over the needle clamp screw. Then screw the dual feed onto the presser foot bar with the presser foot ankle screw.

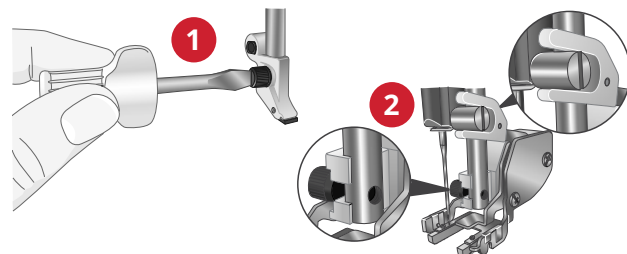

Snap on and Remove the Presser Foot

3. With presser foot bar in the up position, place the presser foot under the dual feed.
4. Push the foot upwards so that it snaps into place.
5. To remove the foot, push the front of the foot upwards until the foot snaps off.

Note: Always keep the dual feed with a foot snapped-on when it is not attached to the machine.

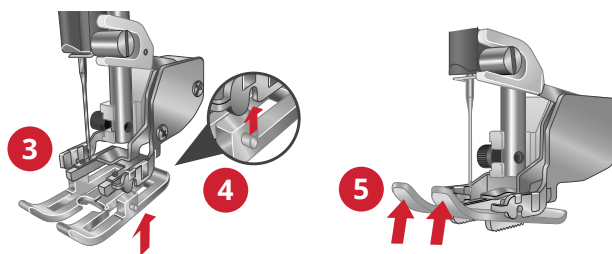

How to Attach the Guide

The two edge/quilting guides included with your machine will help you sew parallel rows of stitching side by side as in channel quilting or tucking. There is one guide for the left side, and one for the right.

6. Insert the guide into the hole in the back of the dual feed. Adjust the space between the foot and the guide by pulling it to the left or to the right.

Note: The edge guides can also be used without the dual feed. Insert one into the hole at the back of the presser foot ankle and tighten the screw.

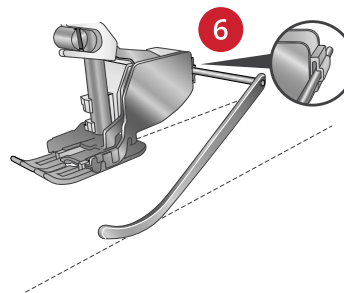

Changing to Straight Stitch Plate

The Straight Stitch Plate is recommended for embroidery. It may also be used for certain techniques in sewing mode, such as quilt piecing. The smaller hole in the Straight Stitch Plate supports the fabric closer to the needle and helps prevent the fabric from being pulled down into the bobbin area, especially at the beginning and/or end of a seam.

1. Remove the presser foot and slide off the bobbin cover.
2. Make sure that the feed teeth are lowered. Place the screwdriver under the needle plate as shown in the picture and gently turn the screwdriver to pop off the needle plate.

Note: Lower the feed teeth by touching the presser foot up and extra lift button.

Note: When changing the needle plate, clean any lint and threads from the bobbin area.

3. With feed teeth lowered, place the straight stitch plate so that it fits into the notch at the back (A). Press the straight stitch plate down until it clicks into place. Slide on bobbin cover.



To prevent needle breakage or damage to the plate, remove any accessory that is not compatible with the Straight Stitch Plate, such as twin needle.

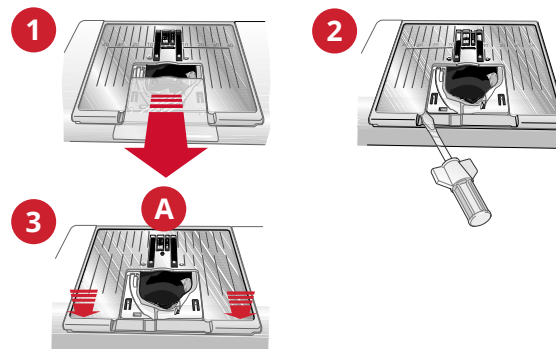

3 Embroidery Preparations

Embroidery Unit

(type BE 17)

1. Embroidery unit release button (underside)
2. Embroidery arm
3. Embroidery hoop attachment
4. Level adjustment feet
5. Embroidery unit plug

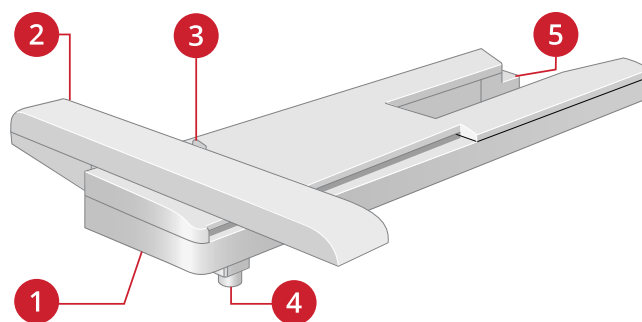

When removing the embroidery unit from the box for the first time, be sure to remove the shipping brace on the underside of the embroidery unit.

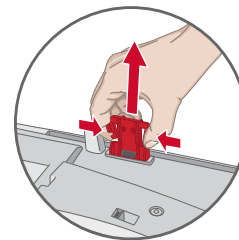

Embroidery Hoop Overview

1. Embroidery hoop connector
2. Outer hoop
3. Inner hoop
4. Center marks
5. Quick release
6. Retaining screw
7. Ribs for fitting the clips

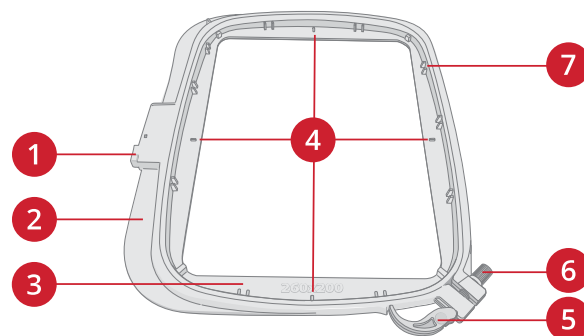

Sensor Q-Foot

The Sensor Q-foot is recommended for hoop embroidery.

See Attaching the Sensor Q-Foot, page 39.

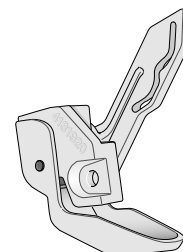

Straight Stitch Plate

The Straight Stitch Plate is recommended for hoop embroidery.

See Changing to Straight Stitch Plate, page 40.

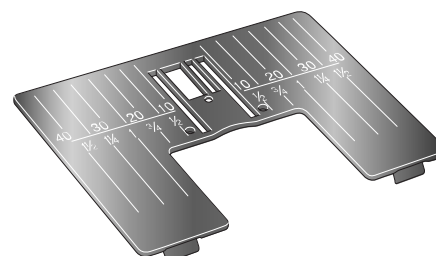

Designs

Over 620 designs are included in the machine memory. These designs, along with the eight built-in embroidery fonts, are shown in the DESIGNER SAPPHIRE™ 85 sampler book.

DESIGNER SAPPHIRE™ 85 Sampler Book

Page through the DESIGNER SAPPHIRE™ 85 sampler book for designs and fonts.

All included designs are pictured and the design number is shown. Information about stitch count (number of stitches in the design) and the design size is also shown, as well as the complete color block list including information about the technique blocks.

Connect the Embroidery Unit

1. Slide the accessory tray off.
2. Slide the embroidery unit onto the free arm of the machine until it plugs firmly into the socket at the back of the machine. If needed, use the level adjusting feet so that the machine and embroidery unit are even. If the machine is turned off, turn it on.
3. If you were already in embroidery mode or when you switch to embroidery mode, a pop-up message tells you to clear the embroidery arm and remove the hoop before calibration. Touch OK. The machine will calibrate and the embroidery arm will move to the ready position.

Note: DO NOT calibrate the machine with the embroidery hoop attached as this can damage the needle, presser foot, hoop and/or the embroidery unit. Be sure to clear all materials from around the machine before calibrating so that the embroidery arm does not bump into anything while calibrating.

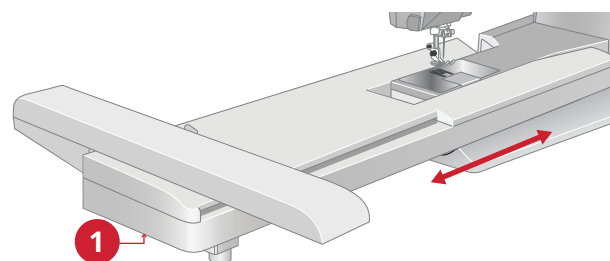

Remove the Embroidery Unit

1. To store the embroidery unit in the embroidery case, move the embroidery arm to park position. See park position .
2. Press the button at the left, underneath the embroidery unit (A) and slide the unit to the left to remove it.
3. Store the embroidery unit in the original black styrofoam packing material, placed in the soft carrying bag.

Hoop the Fabric

For the best embroidery results, place a layer of stabilizer beneath the fabric. When hooping stabilizer and fabric make sure that they are smooth and securely hooped.

1. Open the quick release (A) on the outer hoop and loosen the screw (B). Remove the inner hoop. Place the outer hoop on a firm flat surface with the screw on the lower right (B). There is a small arrow in the center of the lower edge of the hoop which will line up with a small arrow on the inner hoop.
2. Place the stabilizer and fabric, with the right sides facing up, on top of the outer hoop. Place the inner hoop on top of the fabric with the small arrow at the bottom edge. If you can see the hoop size in the lower part of the inner hoop, you have attached it correctly.
3. Push the inner hoop firmly into the outer hoop.
4. Close the quick release (A). Adjust the pressure of the outer hoop by turning the retaining screw (B). The fabric should be taut in the hoop for the best results.

Note: When embroidering additional designs on the same fabric, open the quick release, move the hoop to the new position on the fabric and close the quick release. When changing type of fabric, you might need to adjust the pressure using the retaining screw. Do not force the quick release.

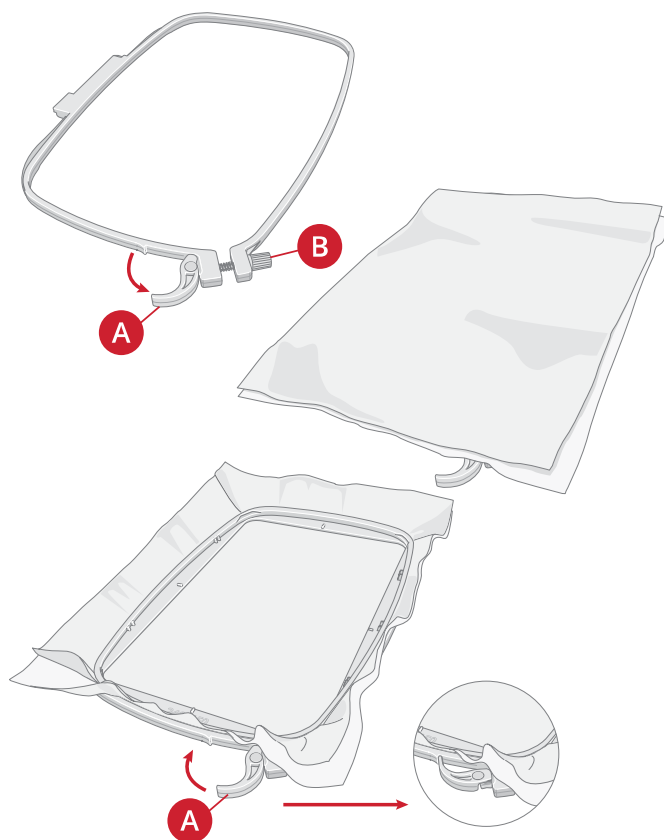

Slide on/off the Hoop

Slide the hoop connector into the hoop attachment (A) from front to back until it clicks into place.

To remove the hoop from the embroidery arm, press the grey button (B) on the hoop attachment and slide the hoop towards you.

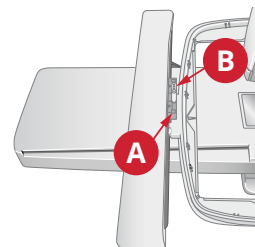

4 The Multi-Touch Screen

Common Functions

The following functions on the screen are used frequently.

OK

Confirms changes and pop-up messages.



Cancel

Cancels changes and pop-up messages.



Embroidery Edit

In the lower right corner of the embroidery edit window, there is a GO button. Touch the button to enter welcome to embroidery stitch out.



Embroidery Stitch Out

Touch the return button in the lower right corner of the embroidery stitch out window to return to embroidery edit.



Touch & Hold

Some buttons have additional functions, marked with an arrow at the lower right corner. To access those functions, touch & hold on the button for a few seconds.



Topbar

On the topbar you will find the following functions: WiFi, *mySewnet*[™], wireless firmware update, home screen, quick help, settings and sewing/embroidery mode toggle.

Note: All functions may not always be available at the same time.



- | | |
|---------------------------------|----------------------------------|
| 1. WiFi | 5. Quick help |
| 2. <i>mySewnet</i> [™] | 6. Settings |
| 3. Wireless firmware update | 7. Sewing/embroidery mode toggle |
| 4. Home screen | |

WiFi

Touch the WiFi button in the topbar and activate WiFi. Select a network from the list of available networks. If your network is password protected, you will be prompted to enter the password in the pop-up.

You can also connect to a network with WiFi in settings.

If you do not get any signal or have a low signal strength see troubleshooting.

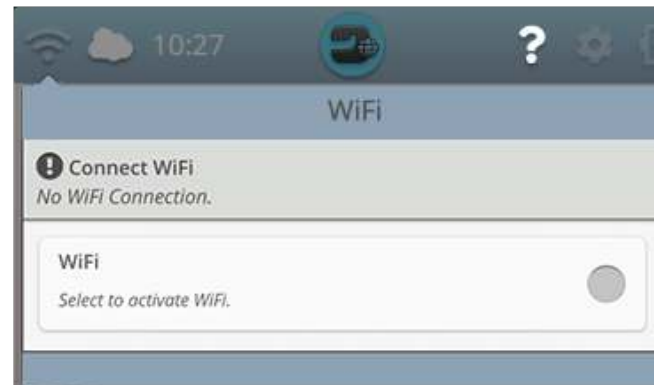

| | |
|--|--|
| | WiFi is connected with high signal strength. |
| | WiFi is connected with medium signal strength. |
| | WiFi is connected with low signal strength. |
| | WiFi is connected but the network does not work properly. |
| | WiFi is disconnected. Connect to a network through the WiFi button or WiFi settings. |

Read more about WiFi in the machine in the WiFi chapter.





mySewnet™

Touch the *mySewnet™* button on the topbar and touch sign in. Sign in to your *mySewnet™* account or create a new *mySewnet™* account.

When signed in you will see how much available space there is left in the *mySewnet™* cloud.

The synchronization status will be shown on the *mySewnet™* button on the topbar:

If your machine cannot connect to *mySewnet™* cloud or does not synchronize, see troubleshooting.

| | |
|---|---|
|  | All files in the machine and <i>mySewnet™</i> cloud are synchronized. |
|  | The machine is currently synchronizing files with the <i>mySewnet™</i> cloud. |
|  | The <i>mySewnet™</i> cloud cannot synchronize with your machine. Check if you have available space on the <i>mySewnet™</i> cloud. |
|  | Signed in to your <i>mySewnet™</i> account but the machine has no WiFi connection. Connect the machine to a WiFi network. |
|  | Not signed in to your <i>mySewnet™</i> account. Log in or create a <i>mySewnet™</i> account to be able to synchronize files from the machine to the <i>mySewnet™</i> cloud. |

Read more about *mySewnet™* cloud in the *mySewnet™* chapter.



Wireless Firmware Update

To be able to get the latest firmware you need to connect to a network using WiFi or update through a USB device. When connected, your machine will automatically search for available firmware update. Touch the firmware update button on the topbar to download and install the latest firmware.

Read more about wireless firmware update in the section firmware update using WiFi.



Home Screen

The home screen is filled with guidance, inspiration and help. Here you'll find the JoyOS ADVISOR™ feature which includes a sewing, quilting and embroidery advisor that will guide you through different techniques and automatically choose correct settings.

Get tips and inspiration through the *mySewnet™* blog, read your user's guide for instant help or find several guides and sewing instructions within the knowledge center.

Read more about the home screen.



Quick Help

Touch quick help on the topbar. Touch an icon, button or an area on the screen you want information about.

Some quick helps will refer to the built-in user's guide for more information. Touch the button to open the built-in user's guide.

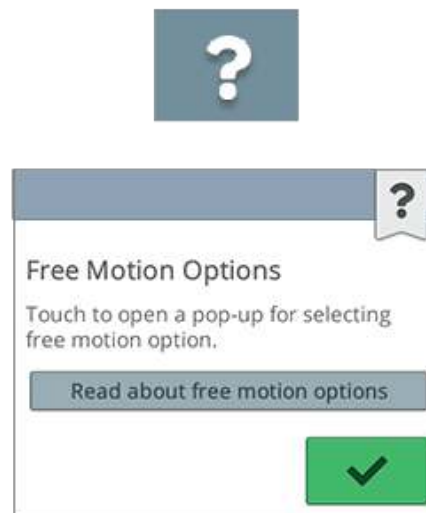

Settings

Touch settings button to open the settings window.

Settings that are recommended will automatically be set when loading stitches and/or designs from the JoyOS ADVISOR™ project menu. This will be indicated with an exclamation mark on the settings button. Touch the button to open settings and see which setting(s) has been changed.



Sewing/Embroidery Mode Toggle

Toggle between sewing and embroidery mode by touching the sewing/embroidery mode toggle in the upper right corner.



Go to sewing mode



Go to embroidery mode

5 WiFi & mySewnet™ Services

WiFi Introduction

Your DESIGNER SAPPHIRE™ 85 machine features WiFi which makes it possible to connect your machine wireless to the *mySewnet*™ services.





Getting Started With WiFi

Touch the WiFi button and activate WiFi. Select a network from the list of available networks. If your network is password protected, you will be prompted to enter the password in the pop-up to be able to connect.

Touch the “information” button to open an information pop-up about the network. You can also see the signal strength and if the network is password protected, indicated with a closed padlock.

You can also connect to a network with WiFi in WiFi settings.

If you do not get any signal or have a low signal strength see troubleshooting.

| | |
|---|--|
|  | WiFi is connected with high signal strength. |
|  | WiFi is connected with medium signal strength. |
|  | WiFi is connected with low signal strength. |
|  | WiFi is connected but the network does not work properly. |
|  | WiFi is disconnected. Connect to a network through WiFi button or WiFi settings. |



Hidden Network



Touch the button to connect to a hidden network. A pop-up will be shown on the screen where you can enter the name of the hidden network.

Firmware Update Using WiFi

It is always recommended to install the latest firmware in your machine.

To be able to get the latest firmware wirelessly you need to connect to a network using WiFi. When connected, your machine will automatically search for available firmware update. If the machine has detected that there is a newer firmware available, the firmware update button will be visible. Touch the button to download and install the latest firmware.

When the update is completed the machine will restart automatically. Check the firmware version number in settings, machine information.

| | |
|--|--|
|  | Indication that your machine does not have the latest firmware. Touch the button to open a pop-up to download and install the latest firmware. |
|  | A spinning wheel will be shown on the firmware update button indicating that the firmware is downloading. |
|  | An exclamation mark will be shown on the firmware update button to notify that there is a downloaded firmware waiting to be installed. |

Firmware Update Using a USB Device

Visit the HUSQVARNA® VIKING® website at www.husqvarnaviking.com and find your machine. Here you will find the available updates.

1. Download the update firmware zip file. Unzip the file and copy the file (.clo) to a USB device.

Note: Do not change the name of the file or do not copy the file into an existing folder on the USB device.

Note: Make sure that there is no old firmware update file (.clo) on the USB stick when copying the new firmware update file (.clo). The file name is not unique.

2. Make sure that the machine is turned off. Connect the USB device loaded with the new firmware version to a USB port on your machine.
3. Press and hold the reverse button, located on the right side of the sewing head, and turn on your machine with the ON/OFF switch. Release the reverse button when an update icon is shown on the screen.
4. The firmware update will be verified and installed. The machine may restart several times during the update process. Do not turn off the machine.
5. When the update is completed the machine will restart automatically. Check the software version number in settings, machine information.

Complimentary Software (PC and MAC)

A computer software package is available for your machine. It adds the following features:

- The *mySewnet*[™] cloud sync tool allows you to synchronize your content in the *mySewnet*[™] cloud and your sewing machine with a folder on your computer. Drag and drop files to the folder on your computer and the files will automatically be transferred to the *mySewnet*[™] cloud and accessible from your machine when signed in to the *mySewnet*[™] account.
- QuickFont program to create an unlimited number of embroidery fonts from most TrueType[™] fonts and OpenType[™] fonts on your computer.
- Plug-in for your Windows Explorer to handle embroidery designs: viewing designs as thumbnail images, reading different embroidery file formats, add trim commands and more.

Visit the HUSQVARNA® VIKING® website at www.husqvarnaviking.com to get support. Select your machine model and download the software.

More information and detailed installation instructions are available on the download page.

mySewnet™ Services

The *mySewnet*™ services contains the following:

- *mySewnet*™ account – A personal login-based account to access the different *mySewnet*™ services.
- *mySewnet*™ cloud – A cloud based service where you will save and access your personal files from three different places: the *mySewnet*™ cloud folder on the machine, the *mySewnet*™ cloud sync tool on your computer and the *mySewnet*™ menu.
- *mySewnet*™ apps – There are several apps available to download for free to your mobile device. For example, you will be able to view current machine and embroidery status through the mySewMonitor app.
- *mySewnet*™ menu – An entrance to all the web services available when you have a *mySewnet*™ account.
- *mySewnet*™ library – A subscription service where you can get access to thousands of embroidery designs. Visit our website to read more about this service and start your subscription.
- *mySewnet*™ blog – A blog with the latest product news, sewing instructions and inspiration.

mySewnet™ Account

Register an account to be able to use the *mySewnet*™ services. You can create your account from *mySewnet*™ button or in *mySewnet*™ settings.

Touch the “Register new account” button and fill in the information required.

An account can also be created through the *mySewnet*™ menu at husqvarnaviking.mysewnet.com.







mySewnet™ Cloud

mySewnet™ cloud is a service where you save and access your personal files, projects, stitches and designs, over the internet instead of on your computer's hard drive. It is available to all owners and users of a mySewnet™ cloud enabled machine. The mySewnet™ cloud offers a simple way to manage and access personal files from different devices:

- mySewnet™ enabled machine.
- PC or MAC
- Smartphone or tablet.

The synchronization status in your machine will be shown on the mySewnet™ button in the topbar:

| | |
|---|--|
|  | All files in the machine and mySewnet™ cloud are synchronized. |
|  | The machine is currently synchronizing files with the mySewnet™ cloud. |
|  | The mySewnet™ cloud cannot synchronize with your machine. Check if you have available space on the mySewnet™ cloud. |
|  | Signed in to your mySewnet™ account but there is no connection to the mySewnet™ server. |
|  | Not signed in to your mySewnet™ account. Log in or register a mySewnet™ account to be able to synchronize files from the machine to the mySewnet™ cloud. |

If your machine cannot connect to mySewnet™ cloud or does not synchronize, see troubleshooting.

Used Space in mySewnet™ Cloud

The mySewnet™ cloud will store designs, fonts, stitches and other files from your machine.

Touch the mySewnet™ button on the topbar or go to mySewnet™ settings. When only a small amount of space is left, your machine will alert you once. If you continue to fill the space, it will not remind you again, until the space is completely full. Delete or move files to a USB device to free space.

Note: The mySewnet™ cloud space gets activated the first time you sign in on your mySewnet™ account from the machine.

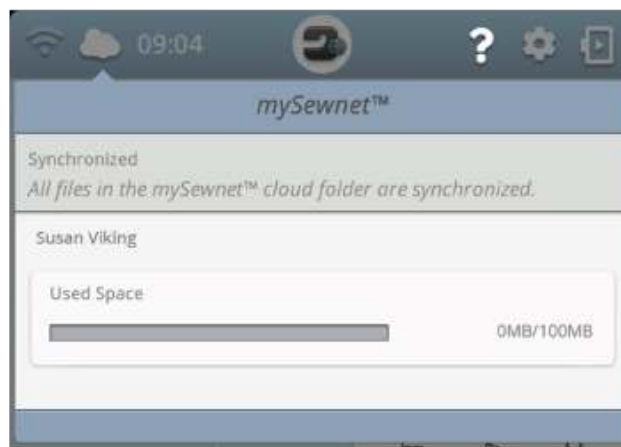

Installation of mySewnet™ Cloud Sync Tool for Computer

Install the *mySewnet*™ cloud sync tool to support synchronization of a local folder on your computer with the content stored in *mySewnet*™ cloud.

To download *mySewnet*™ cloud sync tool for your computer and get detailed installation instructions, go to cloud.mysewnet.com

Apps

There are several apps available to download for free to your mobile device. Visit our website to find and read more about our selection of apps. You can download them directly at App Store and Google Play.

mySewnet™ Menu

The *mySewnet*™ menu is the entrance to all the web services that are available when you have a *mySewnet*™ account.

You can access the menu at www.husqvarnaviking.com to access the following services:

- Account - This is where you register and handle your account.
- *mySewnet*™ cloud – Possibility to manage your personal files. The files are automatically synchronized with the *mySewnet*™ cloud folder in the DESIGNER SAPPHIRE™ 85 machine and the *mySewnet*™ cloud sync tool.
- Help Center - Get help to get started with *mySewnet*™ apps and services.
- Project Creator - A web service where you create and share step-by-step instructions.

mySewnet™ Library

mySewnet™ library is a subscription service where you can get access to thousands of embroidery designs. Visit our website to read more about this service and start your subscription.

If you have a subscription, WiFi is connected and you have logged in to your *mySewnet*™ account, the *mySewnet*™ library menu will be visible in your machine. Here you can scroll and select from all your *mySewnet*™ library designs.

Read more about *mySewnet*™ library

mySewnet™ Blog

In *mySewnet*™ blog you can view the latest product news, sewing instructions and get inspiration!

The machine needs to be connected to WiFi to be able to see the feed.

6 Home Screen

Home Screen— Overview

The home screen is filled with guidance, inspiration and help. Here you'll find the JoyOS ADVISOR™ feature which includes a sewing, quilting and embroidery advisor that will guide you through different techniques and automatically choose correct settings.

Get tips and inspiration through the *mySewnet*™ blog, read your user's guide for instant help or find several guides and sewing instructions within the knowledge center.

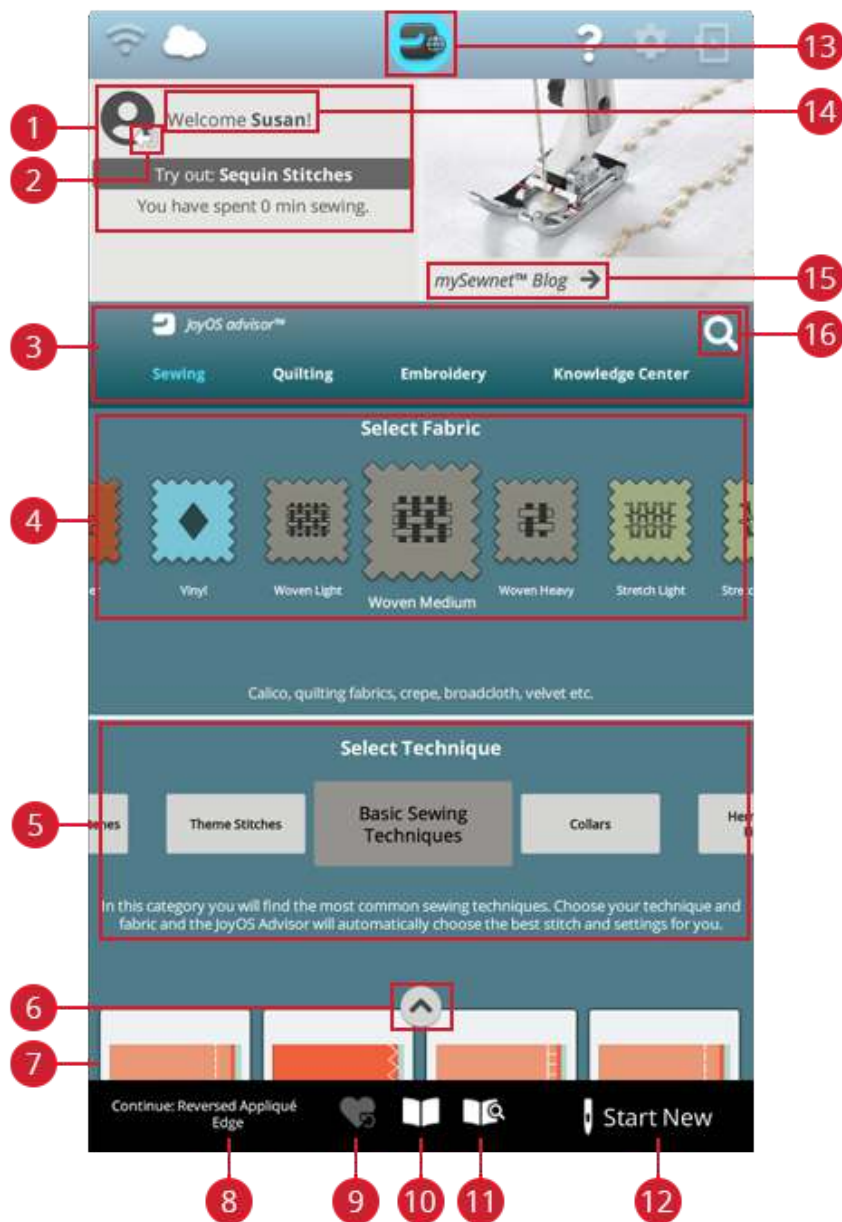

- | | | |
|--|---|----------------------------|
| 1. User profile | 6. Minimize/expand JoyOS ADVISOR™ project files | 11. User's guide |
| 2. Sign in/out <i>mySewnet</i> ™ account | 7. JoyOS ADVISOR™ project files | 12. Start new |
| 3. JoyOS ADVISOR™ feature | 8. Continue JoyOS ADVISOR™ project file | 13. Home screen button |
| 4. Fabric selection | 9. Load smart save | 14. Welcome center |
| 5. Technique selection | 10. JoyOS ADVISOR™ project viewer | 15. <i>mySewnet</i> ™ blog |
| | | 16. Search |

User Profile

If you're not signed in to your *mySewnet*[™] account, there will be a sign in button. When you are signed in to your *mySewnet*[™] account, your user name will be shown. You will receive information on for example how much time you've spent sewing on your machine.

Welcome Center

Your machine will randomly give you tips on JoyOS ADVISOR[™] project files to try out.

If you click on the edit machine nickname button, you can change name of your machine.

This can be useful when owning more than one machine to distinguish one machine from another. The name will be shown on the screensaver.

You can also change your machine's nickname in machine settings.

mySewnet[™] Blog

In *mySewnet*[™] Blog you can view the latest product news, sewing instructions and get inspiration!

Touch on a post to read the full content.

The machine needs to be connected to WiFi to be able to see the feed.

**mySewnet*[™] Blog is only available in selected regions.

If you cannot see the blog on your home screen, it's not available in your language.

Filter *mySewnet*[™] Blog Posts

You can filter blog posts by:

- Sewing instructions
- What's new
- Tips & hints
- Stay connected
- *mySewnet*[™] library

Minimize/expand *mySewnet*[™] Blog

You can minimize *mySewnet*[™] blog tab by touching minimize/expand. Touch again to expand and see the blog posts.

Home Screen — Common Functions

Search

Touch the search tab and a window will open allowing you to search within the JoyOS ADVISOR™. Enter your search and touch OK. The machine will display the search results.

You can also find the search tab in the User's Guide to enable you to search within the User's Guide.



Minimize/Expand Project files

Touch to expand the view of all available project files.

In this view, select fabric and select technique will not be visible.

Touch minimize/expand project files again to go back to default view.

Start New

Always start with selecting the fabric you will sew on. If you want to start sewing without loading any sewing technique, touch the start new button in the bottom right corner. You will enter sewing mode with the selected fabric and a straight stitch will be loaded by default. In sewing mode you can view and select all built-in stitches in the machine from the stitch menu.

If you want to start embroidering without loading an embroidery technique, touch the start new button in the bottom right corner. You will enter embroidery edit. All built-in designs will be shown in the design menu.



Continue

If a technique is loaded and you re-enter the home screen, a continue button with the current loaded JoyOS ADVISOR™ project will be shown. In sewing you can select another fabric. Touch continue button to load the selected fabric into your current JoyOS ADVISOR™ project.

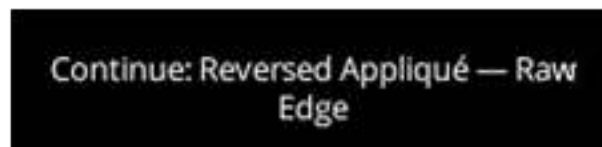

Load Smart Save

Smart save remembers and stores all sewing and embroidery adjustments and settings. This makes it possible to turn off your machine and continue sewing later.

Simply go to the home screen and touch load smart save button. The machine will load the stitch, embroidery and settings as it were when smart save was last performed.

Read about how to smart save.



Project Menu

In the project menu recommended stitches and/or designs will be shown for the current loaded sewing/embroidery technique.



Project Viewer

When loading a JoyOS ADVISOR™ project from the JoyOS ADVISOR™ feature it will be shown in the project viewer which is always accessible on the screen. When the project viewer is minimized, touch the button to expand.



JoyOS ADVISOR™ Project Viewer – Overview

1. Move the viewer on the screen to be able to reach buttons that might be hidden when following the instructions.
2. Decrease or increase the text in the viewer by touching the A- or A+ buttons.
3. Select the fabric that you will use. The stitches loaded through the project are set to fit your selected fabric.
4. To minimize, touch at the top right corner. To expand it again, touch the JoyOS ADVISOR™ project viewer button.
5. Touch the right arrow to step forward in the instruction and touch the left arrow to step backwards.
6. Information shown for each step in the instruction.
7. Every picture can be expanded by touching it in the viewer.
8. Touch the play icon to load an animation. Animations show the step in more detail.
9. Load the recommended stitch for the loaded technique by touching the stitch in the viewer.

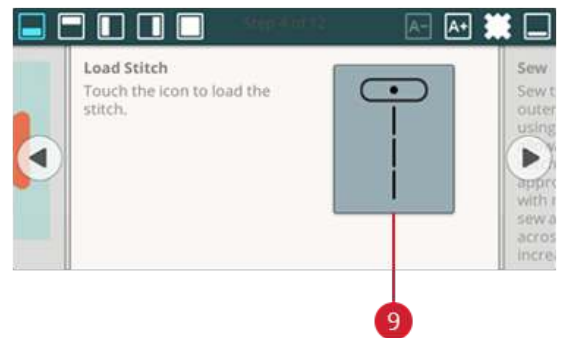
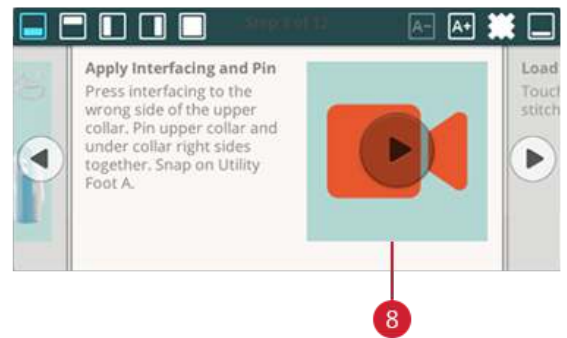
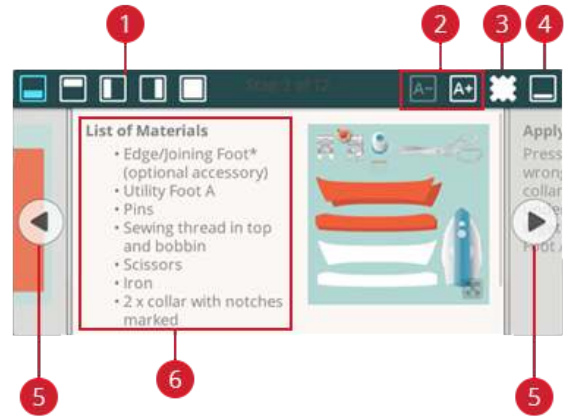

How to Play Animations

In the video player you can pause, rewind, fast forward, set the animation on repeat and turn full screen mode on/off. Touch cancel to close the video player. Touch & hold on rewind to start the animation from the beginning.

1. Watch clip/full animation
2. Rewind (Touch & hold to go to beginning)
3. Play/pause
4. Fast forward
5. Repeat on/off
6. Full screen on/off
7. Close



JoyOS ADVISOR™

SEWING ADVISOR™ – Overview

When loading a sewing technique the machine will select the best stitch and settings for your chosen fabric and project.

Depending on which choices you make, your JoyOS ADVISOR™ feature will recommend the most suitable sewing techniques.

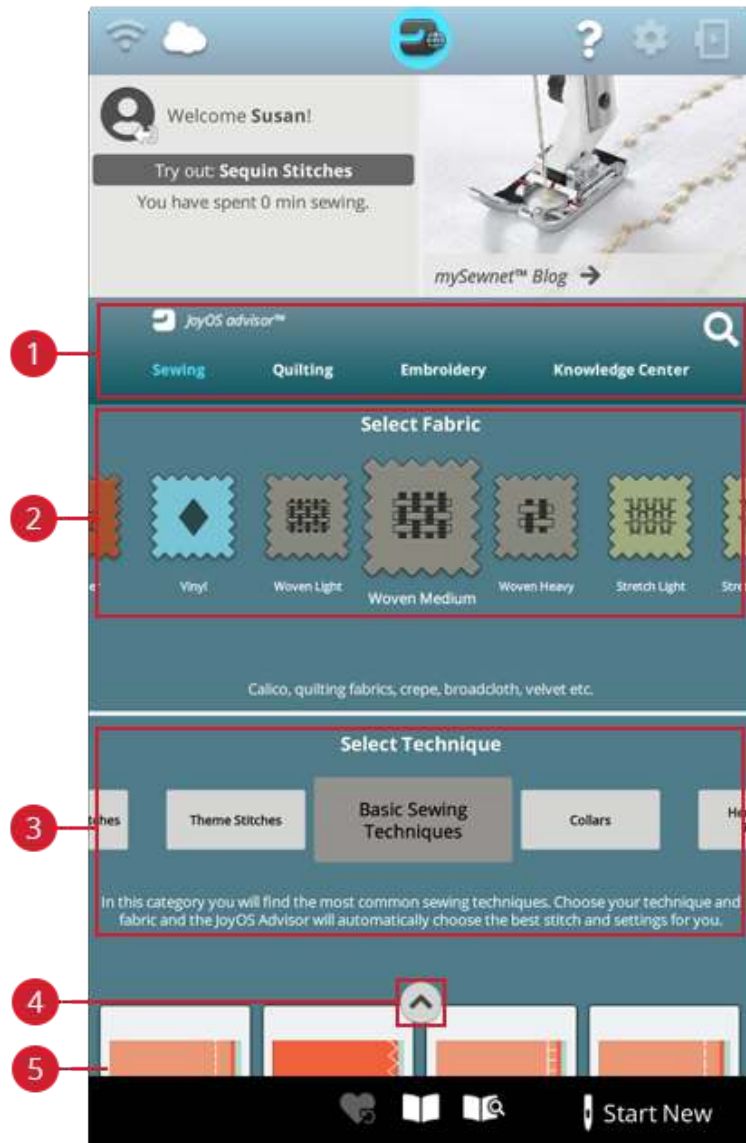

1. JoyOS ADVISOR™ feature
2. Fabric selection
3. Sewing technique groups
4. Minimize/expand JoyOS ADVISOR™ project files
5. Sewing techniques

Fabric Selection

Start your sewing by selecting the fabric that you will use. Suggested fabrics for each fabric group you can choose from are listed below.

Note: Some fabrics have excess dye which can cause discoloration on other fabrics or on your sewing machine. This discoloration may be very difficult or impossible to remove.

Fleece and denim fabric, especially red and blue, often contain excess dye.

If you suspect that your fabric/ready-to-wear garment contains a lot of excess dye, always pre-wash it before sewing/embroidering to prevent discoloration of your machine.

Woven or Knit

The difference between woven and knit fabric is the way the threads are put together. Woven fabrics are made of two thread system, warp lengthwise and weft crosswise, that intersect at right angles. A knit fabric is made of one thread system with interlaced stitches. A knit fabric usually has stretch.

As a general rule, select woven in the JoyOS ADVISOR™ feature for stable fabrics that have no stretch and stretch for fabric that have stretch.

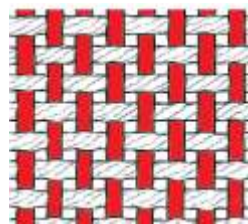

Woven fabric

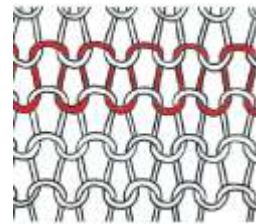

Knit fabric

Woven Fabrics

Woven Light: Chiffon, organza, batiste, challis, crepe de chine, etc.

Woven Medium: Calico, quilting fabrics, crepe, broadcloth, velvet, etc.

Woven Heavy: Denim, tweed, canvas, terrycloth, etc.

Stretch Fabrics

Stretch Light: Tricot, single knit jerseys, etc.

Stretch Medium: Sweater knits, double knit, velour, swimwear, etc.

Stretch Heavy: Sweater knits, fleece, etc.

Leather and Vinyl

For suede and leather. Leather is animal skin with the coat (fur) removed. Leather can be smooth or sueded and has some give.

For vinyl and faux leather. Vinyl is a synthetic material which often has a woven wrong side. Vinyl can be smooth or patterned and some vinyls have stretch.

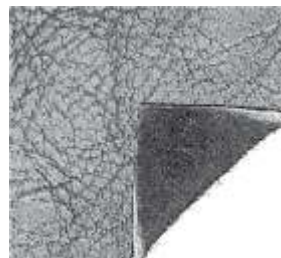

Leather fabric



Vinyl fabric

Sewing Technique Groups

After selecting a fabric, touch a sewing technique group and the JoyOS ADVISOR™ feature will recommend sewing techniques suitable for your fabric. Touch a sewing technique to load it into the JoyOS ADVISOR™ project viewer.

Example: Select woven medium and zippers to show all zipper techniques suitable for woven medium. Change fabric to stretch medium and notice that not all zipper techniques are available since all are not suitable for stretch medium.

Note: Use quick help on a sewing technique for a short description of the technique.

QUILT ADVISOR– Overview

The Quilt Advisor gives you guidance for different kinds of quilting techniques. When selecting a quilting technique the machine will show all techniques for your chosen quilting technique group.

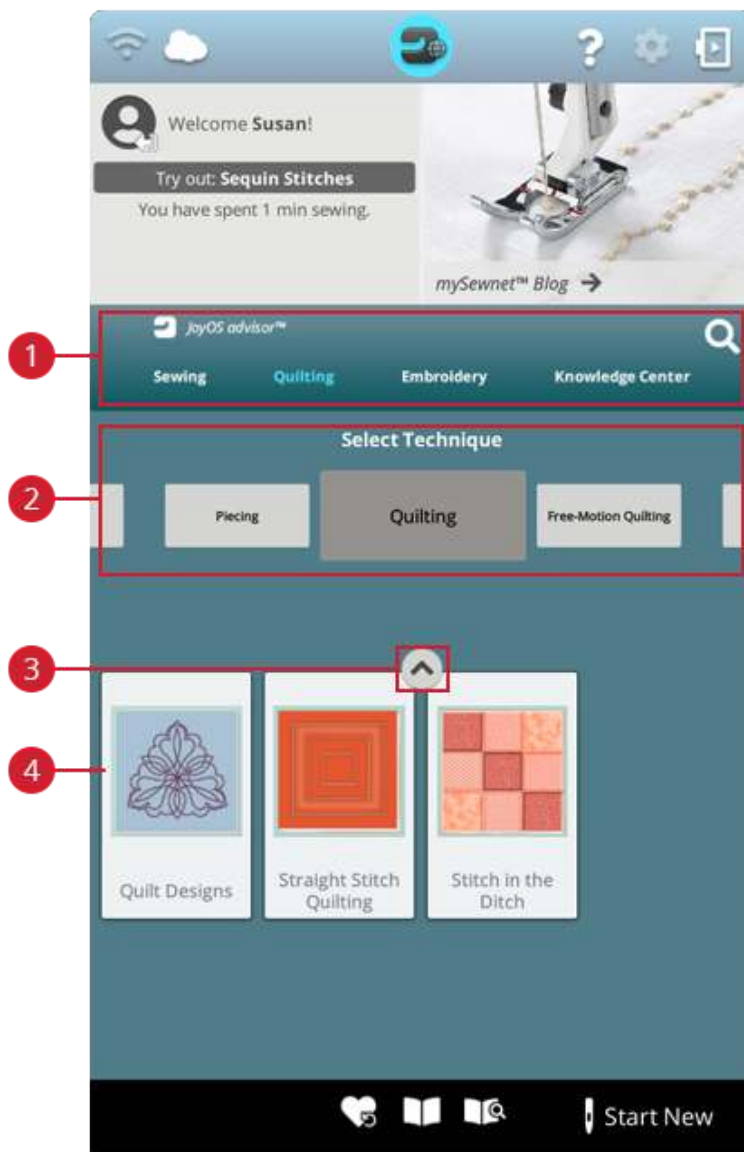

1. JoyOS ADVISOR™ feature
2. Quilting technique groups
3. Minimize/expand JoyOS ADVISOR™ project files
4. Quilting techniques

Quilting Technique Groups

Touch a quilting technique group and the JoyOS ADVISOR™ feature will show available quilting techniques in that group. Touch a quilt technique to load it into the project viewer. There are different quilting technique groups in the Quilting Advisor.

EMBROIDERY ADVISOR™ – Overview

The EMBROIDERY ADVISOR™ gives you guidance for different kinds of embroidery techniques. When selecting an embroidery technique the machine will show all techniques for your chosen embroidery technique group.

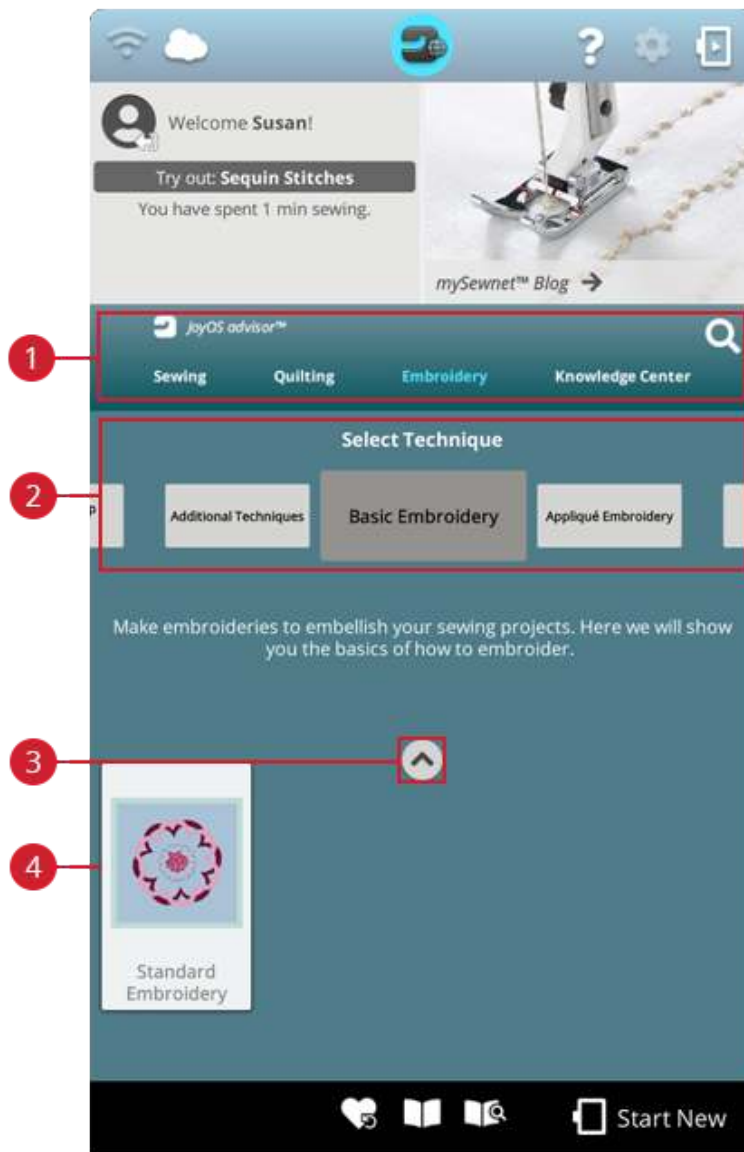

1. JoyOS ADVISOR™ feature
2. Embroidery technique groups
3. Minimize/expand JoyOS ADVISOR™ project files
4. Embroidery techniques

Embroidery Technique Groups

Touch an embroidery technique group and the JoyOS ADVISOR™ feature will show available embroidery techniques in that group. Touch an embroidery technique to load it into the JoyOS ADVISOR™ project viewer.

Note: Use quick help on an embroidery technique for a short description of the technique.

Knowledge Center – Overview

The JoyOS ADVISOR™ feature also contains a knowledge center including: stabilizer guide, quick start guide, sewing instructions, step-by-step workbook and an accessory guide.

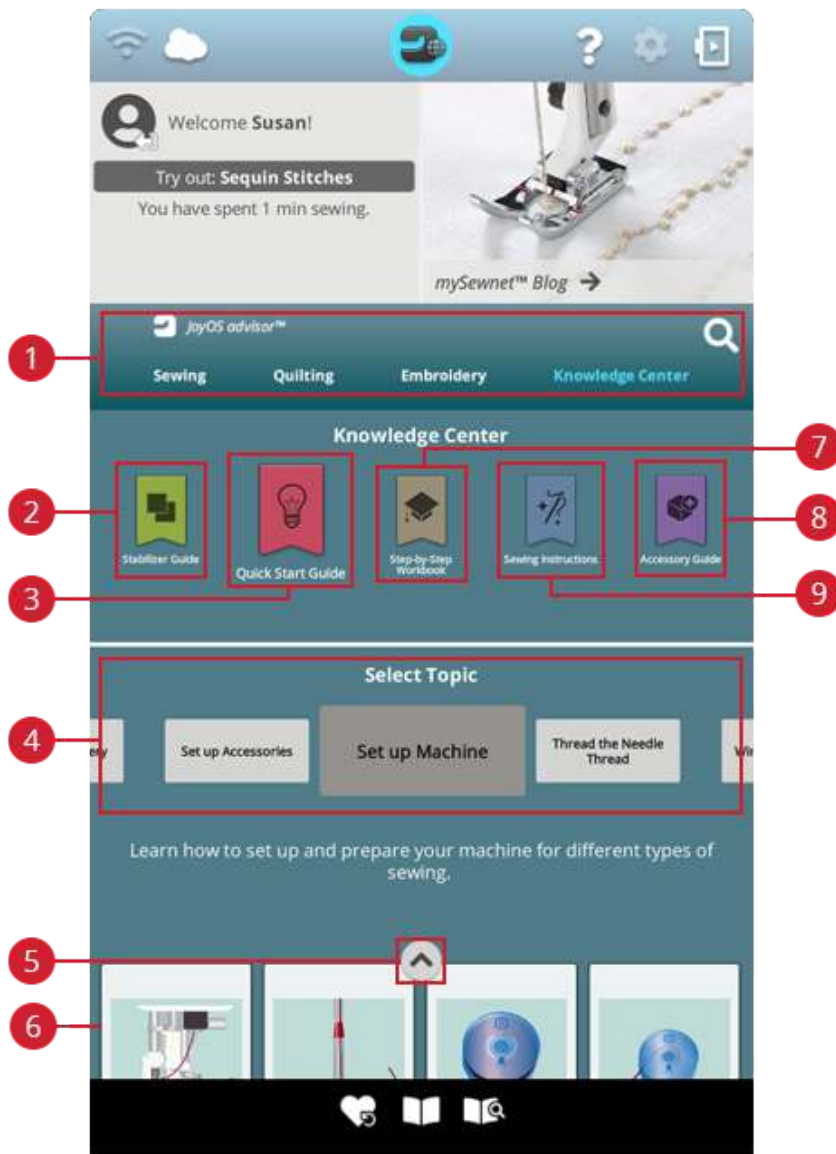

- | | |
|---|---|
| 1. JoyOS ADVISOR™ feature | 6. Available techniques of chosen group |
| 2. Stabilizer guide | 7. Step-by-step workbook |
| 3. Quick start guide | 8. Accessory guide |
| 4. Technique groups | 9. Sewing instructions |
| 5. Minimize/expand JoyOS ADVISOR™ project files | |

Stabilizer Guide

Select a stabilizer group to view different stabilizers within the group. Touch a stabilizer to see more information about when to use it. Here you'll find an overview of different types of stabilizers.

- **Cut away:** Cut away stabilizers are stabilizers that needs to be cut away by using scissors. It will stay on the fabric to make the embroidery more stable.
- **Batting:** Use batting between your top fabric and backing to add body to your JoyOS ADVISOR™ project.
- **Water soluble stabilizer:** The stabilizers in this category are stabilizers that dissolves in water. They are very useful when embroidering lace and cutwork embroideries.
- **Specialty:** In this category you will find stabilizers for special uses.
- **Tear-a-away:** Tear-a-way stabilizers are temporary stabilizers. They are easy to remove after embroidering.

Quick Start Guide

Here you'll find quick start guides e.g. on how to thread the machine. Select one of the topics to get guidance directly in the viewer.

Step-by-Step Workbook

Here you will find step-by-step instructions on how to use special techniques and functions. Select a topic to view the projects within that group. Touch to load it into the project viewer.

Note: Minimize/expand your project viewer to be able to view all functions when stepping through the technique.

Sewing Instructions

Here you'll find complete sewing instructions.

Accessory Guide

Here you'll find project files that shows you how to use different sort of accessories available for your machine.

7 Sewing

Getting Started to Sew

When your DESIGNER SAPPHIRE™ 85 machine starts, the home screen featuring the JoyOS ADVISOR™ will be opened automatically.

Always make sure that the type of fabric you intend to sew on is selected in the JoyOS ADVISOR™ feature.

Read more about the fabric selections.

After your fabric is chosen, select a special sewing technique you would like to sew or you can touch start new. When a special sewing technique is chosen you will receive detailed instructions in the JoyOS ADVISOR™ project viewer. If you touch start new you will enter sewing mode and the straight stitch will be loaded by default. Read more about the JoyOS ADVISOR™ feature.

Sewing Mode – Overview

In sewing mode you can select stitches, adjust and sew them. Your selected stitch will be shown in actual size in the stitch field. The sewing recommendations will be shown at the top.

You can also go to program mode to create your own stitch program. Read more about how to program stitches in program.

Note: All symbols and options will not be shown at the same time.

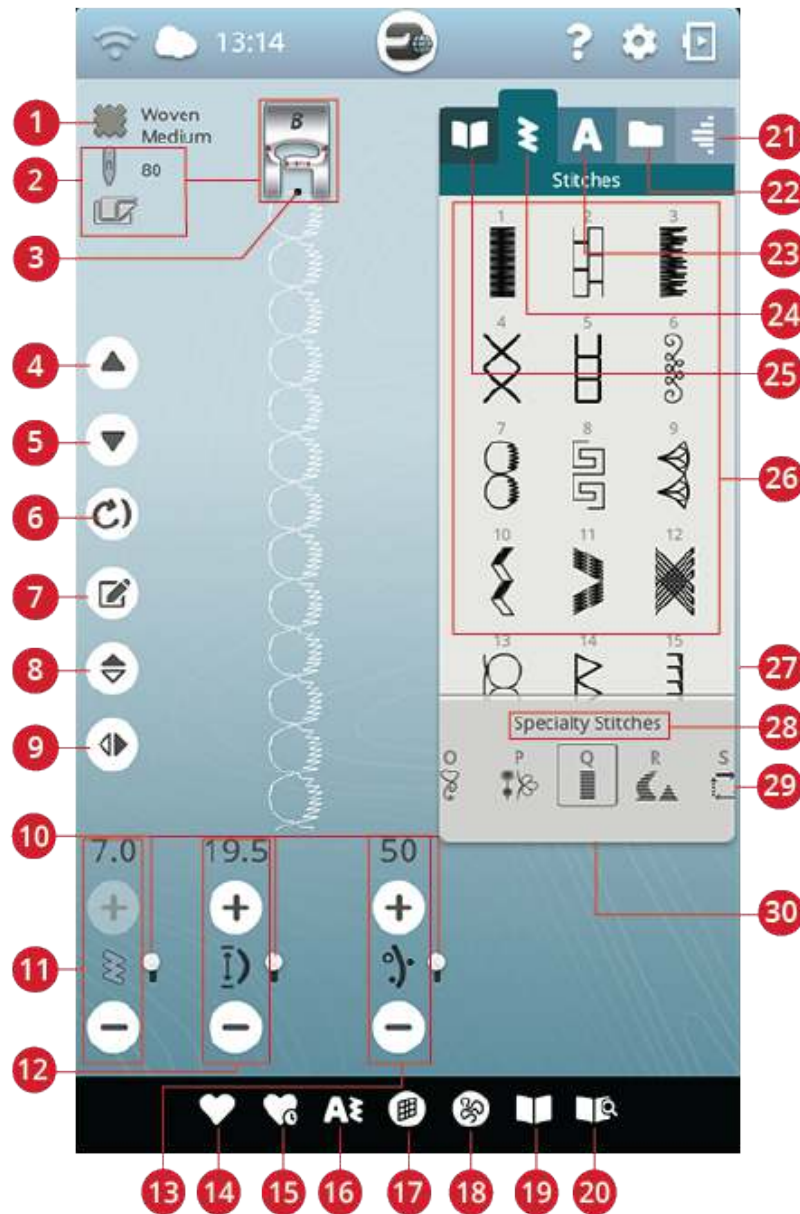

- | | | |
|-------------------------------------|---|------------------------------------|
| 1. Fabric selected | 12. Stitch length/stitch density | 22. File manager |
| 2. Sewing recommendations | 13. Thread portioning or thread tension or sensor foot pressure | 23. Font menu |
| 3. Stitch start | 14. Save | 24. Stitch menu |
| 4. Step to previous stitch | 15. Smart save | 25. JoyOS ADVISOR™ project menu |
| 5. Step to next stitch | 16. Program | 26. Selection area |
| 6. Stitch re-start | 17. Balance stitch | 27. Stitch information |
| 7. Edit stitch program | 18. Free motion options | 28. Stitch menu name |
| 8. Mirror end to end | 19. JoyOS ADVISOR™ project viewer | 29. Stitch categories |
| 9. Mirror side to side | 20. User's guide | 30. Minimize/expand selection area |
| 10. Alternative switch bar | 21. Tapering menu | |
| 11. Stitch width/stitch positioning | | |

What is a Stitch?

A stitch either consists of a single stitch as in a straight stitch, or as two individual stitches e.g. in a zigzag. Furthermore, a stitch is also the complete stitch, meaning it is made up by the total of the individual stitches in the stitch, such as a 3 step zigzag or a decorative stitch.

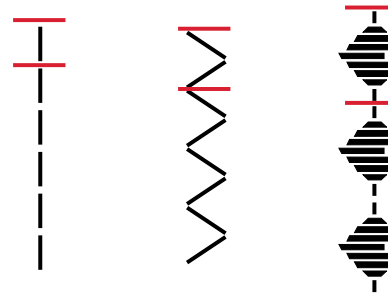

Select a Stitch or Letter

To load a stitch, open the stitch menu and touch a stitch to select it. The stitch will automatically be loaded and information will be shown in the stitch information area. Swipe up and down in the stitch menu to scroll through the stitches. Swipe left/right to scroll to and select a different stitch category. Alternatively swipe left/right in the category list and touch a category to select it.

To create text, select the font menu and touch a font to select it. When a font is selected it will automatically be loaded into program mode. Program your text by using the keyboard. Minimize the keyboard and touch OK in the program window. Your text will be loaded to sewing mode and ready to be stitched out. Learn more on how to program stitches and letters in the program chapter.

Load a Stitch or Letter From Another Location

From the file manager you can load stitches or programs that you have saved in your *mySewnet*TM cloud folder or on a USB device. Open file manager and load a stitch or program by touching & holding on the file. In file manager you will see all your saved files e.g. stitches, designs and fonts. Learn how to organize your files in file manager.

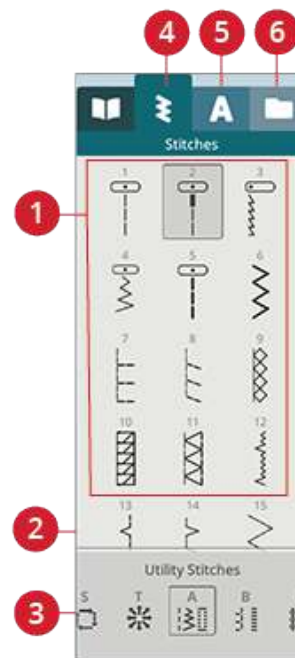

1. Selection area
2. Stitch information
3. Stitch categories
4. Stitch menu
5. Font menu
6. File manager

Sewing Recommendations

Your machine will show the selected fabric and the active stitch. It will also show sewing recommendations which are set automatically depending on the selected fabric, active stitch and current settings. You can change the selected fabric directly, by touching the fabric icon. The following recommendations can be shown: presser foot, needle, stabilizer and glide plates. The Straight Stitch Plate recommendation will be shown when a free motion option is selected with a straight stitch.

Tip: We recommend that you use the stabilizer guide in JoyOS ADVISOR™ for detailed information about the different stabilizers.

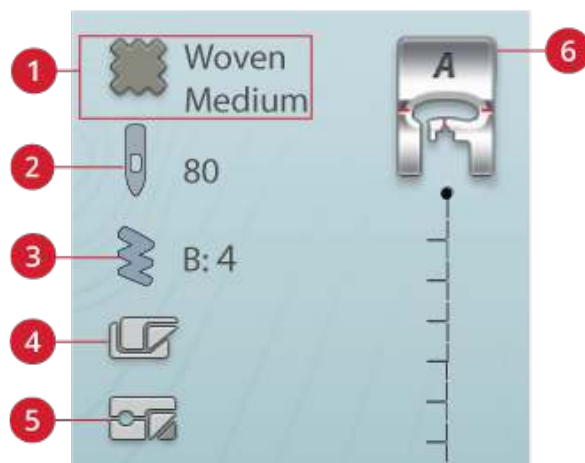

- | | |
|--------------------------------|---|
| 1. Fabric selected | 6. Presser foot recommendation |
| 2. Needle recommendation | 7. Straight Stitch Plate recommendation |
| 3. Stitch selected | |
| 4. Stabilizer recommendation | |
| 5. Glide plates recommendation | |

Stitch Settings

Your machine will set the recommended settings for each selected stitch. You can make your own adjustments to the selected stitch. The changes will only affect the selected stitch and will be reset to default when selecting another stitch or turning your machine off. To save your adjusted stitch, touch save.

The controls available on the screen will change depending on what stitch or program is loaded. Some stitches have more than one control, and an alternative switch bar will appear. Touch the alternative switch bar to change to an alternative control for a different stitch setting. Touch it again to change back to the previous control. The different stitch settings are described below.

Note: When trying to exceed minimum or maximum settings for width and length, a warning sound will be heard. The default setting is always shown in black numbers.

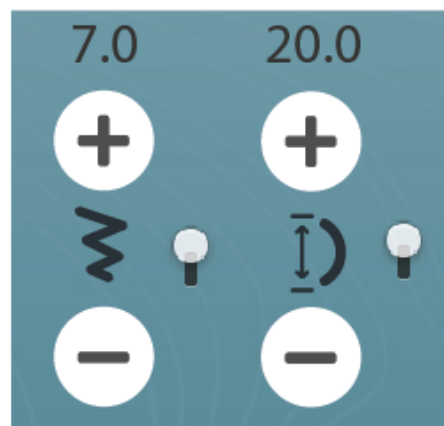

Stitch Width

Increase or decrease the stitch width using + and - in the control. The number above the control shows stitch width in mm/inch.

Changed stitch position may limit the stitch width adjustments.



Stitch Positioning

On certain stitches with a width less than 9mm it is possible to change the stitch position. Use + to move the stitch to the right and - to move the stitch to the left. The number above the control shows the needle start position in mm/inch in relation to center needle position. The machine has a maximum of 37 needle positions (for a straight stitch).

The stitch position can only be changed to the limit of the maximum stitch width. Changing the stitch positioning will also limit the stitch width adjustments.



Stitch Length

Increase or decrease the stitch length using + and - in the control. The number above the control shows the set stitch length in mm/inch. If lengthening a zigzag stitch or a decorative stitch, the entire stitch will be stretched out. If lengthening a stitch where the density can be adjusted, the entire stitch will be longer but the density of the satin stitches will remain the same.



Stitch Density

The stitch density control adjusts the density (the distance between the individual satin stitches that make up the entire stitch). The density does not affect the actual length of the entire stitch.

Touch + to decrease the density. Touch - to increase the density. The number above the control shows the distance between satin stitches in mm/inch.

Tip: Decrease the density to get different visual effects e.g. when using speciality threads.



Button Size

When sewing a buttonhole with the Sensor One-Step Buttonhole Foot, you can set the button size. Measure your button with the ruler on the front of the machine and set the button size in the button size control. Sew a test buttonhole on a fabric scrap to verify the desired length of the buttonhole.



Sew On Button

When sewing a button, you can set the number of stitch repeats. Touch the + or - in the control to increase or decrease the number of stitch repeats.



Sensor Foot Pressure

Touch + to increase or - to decrease the pressure of the presser foot on the fabric.

Note: Touch the alternative switch bar on the thread portioning/thread tension control to switch to sensor foot pressure control.

EXCLUSIVE SENSOR SYSTEM™

Thanks to the EXCLUSIVE SENSOR SYSTEM™ feature, the presser foot automatically and continuously senses and adjusts as you sew any thickness of fabric for perfect even feeding.

Go to sewing mode to see the actual setting of the sensor foot pressure for the selected fabric and adjust the presser foot pressure.



deLuxe™ Stitch System

The deLuxe™ stitch system has two ways to control the upper thread: thread portioning and thread tension. To get the best sewing result it will automatically use thread portioning when possible. Thread portioning automatically and continuously measures the fabric thickness to portion the correct amount of thread for the selected stitch.

When thread tension is used, the tension discs will keep the correct amount of tension on the upper thread. Some special techniques may require the use of thread tension. Deselect the deLuxe™ stitch system in the temporary sewing settings to ensure that thread tension is engaged. When the deLuxe™ stitch system is selected in temporary sewing settings the control visible in sewing mode will change between thread portioning and thread tension depending on the current settings and the loaded stitch.

Use the thread portioning/thread tension control to adjust the balance between needle thread and bobbin thread, e.g. decrease when using metallic thread and increase when using heavy weight thread. Make a few tests with different settings on a scrap piece of the fabric you are going to use and check the balance between the upper thread and the bobbin thread.

Note: When changing the value of the thread portioning/thread tension setting, the changes only affect the selected stitch. Your changed settings will be reset to default when selecting another stitch.

Tip: Increase the thread portioning/thread tension setting for best results when sewing on denim fabric with thick threads.



Thread portioning control



Thread tension control

Adjust Thread Tension/Thread Portioning

For the best stitch appearance and durability make sure the threads meet evenly between the two fabric layers.



Correct tension

If the bobbin thread is visible on the top side of the fabric, the thread tension/thread portioning is too tight. Reduce the thread tension/thread portioning.

If the upper thread is visible on the back side of the fabric, the thread tension/thread portioning is too loose. Increase the thread tension/thread portioning.

For decorative stitches and buttonholes the upper thread should be visible on the back side of the fabric.

Make a few tests on a scrap piece of the fabric you are going to use and check the tension.

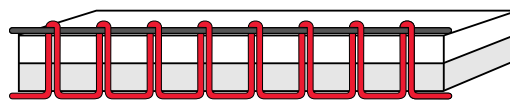

Tension too tight

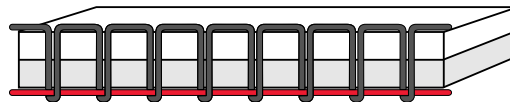

Tension too loose

Mirroring

To mirror a stitch or stitch program lengthwise, touch the mirror end to end button. To mirror a stitch or stitch program sideways, touch the mirror side to side button.

Tip: Use the smart toolbox to open a shortcut for mirroring.

Note: Some stitches e.g. buttonholes cannot be mirrored.

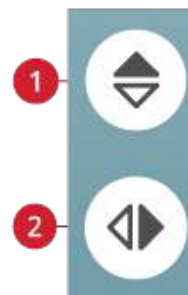

1. *Mirror end to end*
2. *Mirror side to side*

Stitch Re-Start

When you stop sewing in the middle of a stitch, touch stitch re-start to begin sewing at the beginning of the stitch. The stitch or stitch program will remember any special settings you made.



Save Stitch

To save your file, touch the save button. You can choose to save the file to the *mySewnet*[™] cloud folder or to a USB device. Previously saved designs, stitches, programs and/or fonts are shown. Name your file and touch the OK button.

If you want to save to a folder, simply touch & hold on the folder to open it, then name your file and touch OK. To create a new folder, simply touch the create new folder button, name the folder with the keyboard and touch OK. Then touch & hold on the folder to open it and save into the new folder.

Touch the list and thumbnail view button to toggle between showing the files in a list or as thumbnail icons.

To cancel the save process, close the pop-up window by touching cancel. The save pop-up will close and you will return to sewing mode.

Read more about organizing your saved stitches in file manager.

Smart Save

If you want to stop sewing and save your current stitch and settings, touch the smart save button. A pop-up will indicate that a smart save has been done and you can now turn off the machine.

Smart save remembers and stores the stitch, embroidery and settings as they were when smart save was last performed. This makes it possible to turn off your machine and continue sewing later. To load smart save, touch the load smart save button in the JoyOS ADVISOR[™] feature.

Your smart save will be saved until you touch the smart save button again and replace it.



Save button

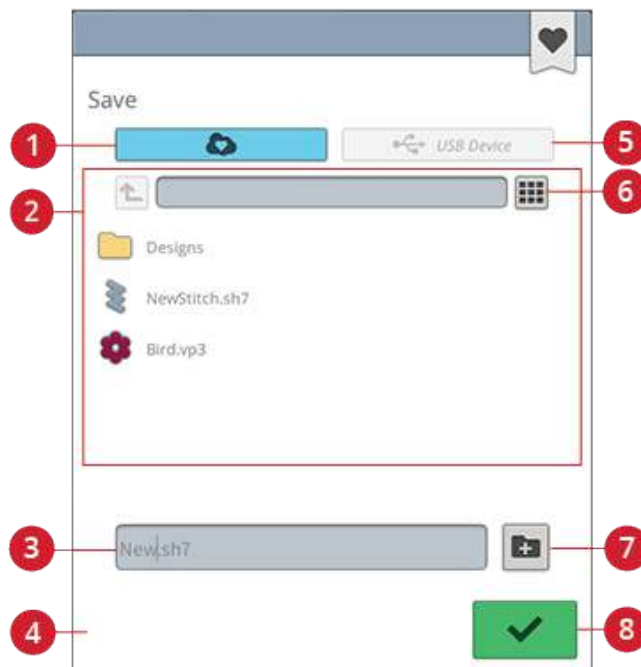

- | | |
|--|----------------------------|
| 1. Save to <i>mySewnet</i> [™] cloud folder | 5. Save to USB device |
| 2. Selection area | 6. List and thumbnail view |
| 3. File name | 7. Create new folder |
| 4. Cancel | 8. Confirm |



Smart save button



Home screen button



Load smart save button

Balance

When sewing on special fabrics or doing a special technique, the balance may need to be adjusted. To adjust the balance on the active stitch, touch the balance button in sewing mode.

Start by sewing the stitch on a piece of scrap fabric. Change the preview on the screen to match your sewn sample by using the + and - in the controls. When you sew again, the balance will be corrected.



Balance button in sewing mode

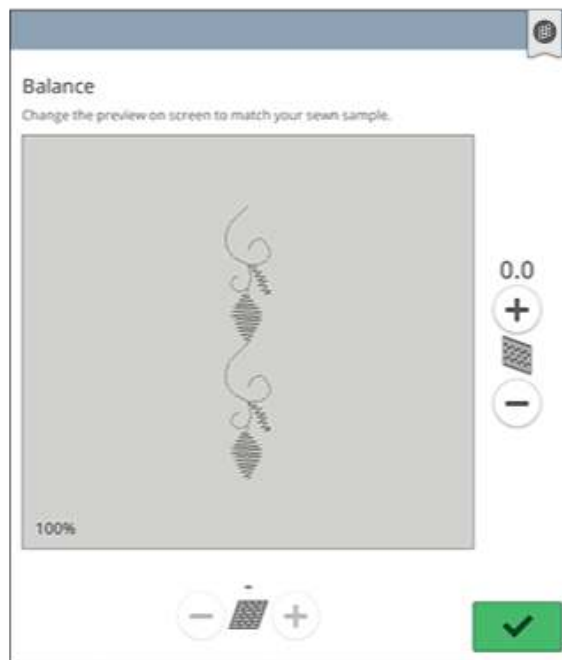

Pop-up window for balance

Free Motion Options

Choose between three free motion options: free motion spring action, free motion ruler foot, or free motion floating.

When sewing free motion with a straight stitch, use the Straight Stitch Plate for best result. Read about how to change to Straight Stitch Plate.

Free Motion Spring Action

Activate free motion spring action to set the machine in free motion spring action mode for spring action feet, e.g. the Sensor Q-Foot. The feed teeth will lower automatically.

A spring action foot will raise and lower with each stitch to hold the fabric on the needle plate while the stitch is being formed. When sewing, you need to move the fabric manually.

Sensor Q-Foot is recommended for all free motion sewing except when using specific techniques or accessories that do not support the use of Sensor Q-Foot.



The free motion spring foot icon will be shown in the sewing recommendations.

Tip: There is an optional open toe free motion spring foot that can be purchased at your local authorized retailer.

Free Motion Ruler Foot (Optional)

Activate free motion ruler foot to set the machine in free motion mode for the optional free motion ruler foot. The feed teeth will lower automatically.

The presser foot floats over the fabric while sewing.

Free Motion Options

When sewing free motion with a straight stitch, use the Straight Stitch Plate for best result.

-  **Free Motion Spring Action (e.g. Sensor Q-Foot)**
The spring foot will raise and lower with each stitch. Feed teeth will be lowered and thread tension will be used. Sensor Q-Foot is recommended for all free motion sewing except when using specific techniques or accessories that do not support the use of Sensor Q-Foot.
-  **Free Motion Ruler Foot (Optional)**
The presser foot floats over the fabric. Feed teeth will be lowered automatically.
-  **Free Motion Floating (e.g. R-Foot)**
The presser foot floats over the fabric at higher speed. Feed teeth will be lowered and thread tension will be used. Note: Do not use this mode when sewing with the optional Free Motion Ruler Foot.



Free Motion Floating

Activate free motion floating to set the machine in free motion floating mode for floating feet, e.g. the R-Foot. The feed teeth will lower automatically.

When sewing at low speed the presser foot will raise and lower with each stitch to hold the fabric on the needle plate while the stitch is being formed. At higher speed, the presser foot floats over the fabric while sewing. The fabric must be moved manually.

Skipped stitches can occur if your fabric moves up and down with the needle as you are stitching. Lowering the presser foot height will reduce the space between the presser foot and the fabric and eliminate the skipped stitches.

Note: Be careful not to reduce the presser foot height too much. The fabric must still move freely under the presser foot.

To adjust the presser foot height in free motion floating mode, touch the presser foot height control to make adjustments.



The free motion floating foot icon will be shown in the sewing recommendations.

Note: If free motion floating is activated, do not use a spring action foot, as this might damage the presser foot.

Note: Activate stitch width safety if the presser foot requires it.

Tip: There are optional free motion floating feet that can be purchased at your local authorized retailer.

Basic Sewing Techniques

In basic sewing techniques you will find the most commonly used sewing techniques. When you choose one of the basic sewing techniques, the recommended stitch for the chosen fabric is automatically loaded.

Seam

A seam sews two pieces of fabric together with a seam allowance that will usually be pressed open. In most cases, edges of the seam allowance are finished with an overcast stitch before sewing the seam.

Seams in stretch fabric must stretch with the fabric. The stretch stitch makes a stretchy seam that is suitable for sewing together pieces of light stretch fabric.

Your JoyOS ADVISOR™ feature will select the best stitch length and stitch width for the fabric weight and recommend the presser foot and needle.

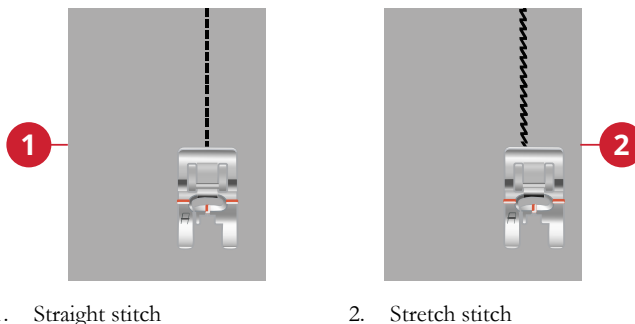

Overcast

Overcast fabric edges to prevent fraying and to help them lay flat. It is easier to overcast before the garment is sewn together.

Your JoyOS ADVISOR™ feature will select the best stitch length and stitch width for the fabric weight and recommend the presser foot and needle.

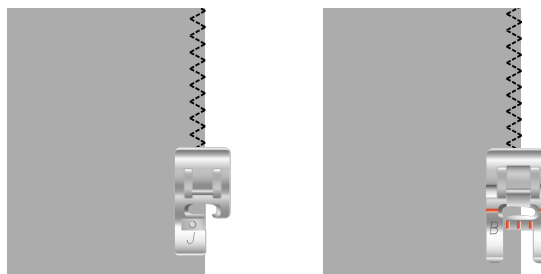

Seam and Overcast

The seam/overcast stitch sews the seam and overcasts the edges all at one time. The seam/overcast technique is perfect for stitching ribbed neckbands and cuffs. There are a number of different seam/overcast stitches in your machine.

Your JoyOS ADVISOR™ feature will select the best one for your fabric and make all adjustments automatically and recommend the presser foot and needle.

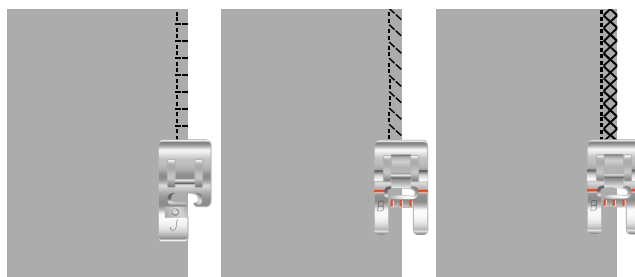

Baste

Basting is temporary stitching for fitting garments, gathering and marking. The JoyOS ADVISOR™ feature automatically sets a long stitch length and reduces the tension so the threads are easy to remove or to pull for gathering.

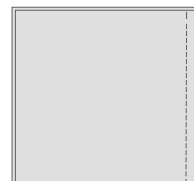

Blind Hem

The blind hem creates an invisible hem on garments. There are two types of blind hem; one is recommended for medium to heavy fabrics, the other for stretch. The blind hem is not suggested for light weight fabric, leather and vinyl.

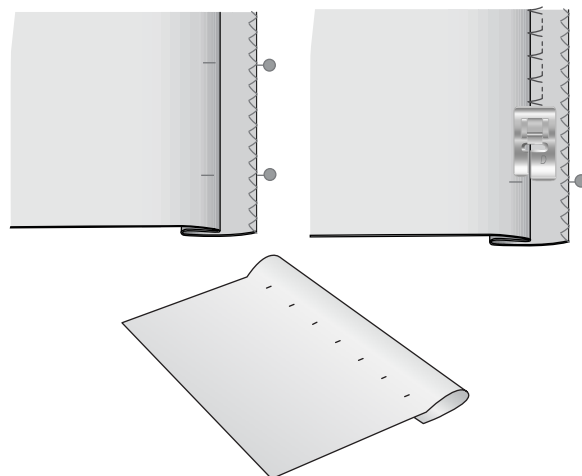

Hem

The hem technique on your JoyOS ADVISOR™ feature will select the visible or topstitch hem that is best for your fabric weight and type. For woven fabric, leather and vinyl a straight stitch is selected. For stretch fabrics, stitches that stretch are selected.

Buttonholes

The JoyOS ADVISOR™ feature will select the best buttonhole and stitch settings for your chosen fabric. Fabric should be interfaced and/or stabilized where buttonholes are to be sewn.

Tip: In your accessory tray there is a special book where you can hang your Sensor One-Step Buttonhole Foot.

Sew a test buttonhole on a fabric scrap to verify the desired length of the buttonhole.

Measure the desired distance from the fabric edge and then add the length of your buttonhole.

When sewing, place the finished fabric edge with stabilizer underneath the presser foot, facing away from you.

Use the marking on your fabric to position the starting point.

Manual Buttonhole

Manual buttonholes are recommended for woven heavy fabric. To sew a manual buttonhole, use the buttonhole foot C.

1. Sew the first column as long as you want the buttonhole to be.
2. Touch the reverse button. The machine sews the bartack and the second column.
3. When the columns are aligned, touch the reverse button to sew the second bartack.
4. Touch the STOP function to sew the same length repeatedly.

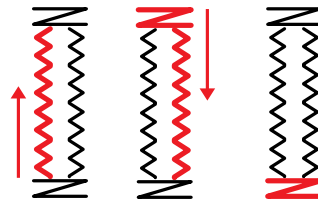

Sewing direction for buttonholes without satin stitches or satin stitch buttonholes sewn with presser foot C.

Automatic Buttonhole

When sewing buttonholes on woven light, woven medium, stretch light or vinyl fabric you can use the Sensor One-Step Buttonhole Foot. The Sensor One-Step Buttonhole Foot will sew automatic buttonholes. Read about how to attach the Sensor One-Step Buttonhole Foot.

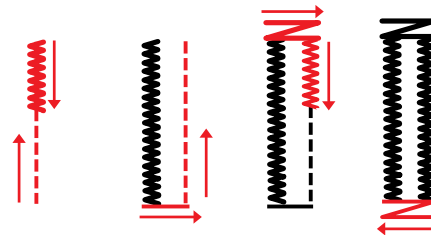

Sewing direction for satin stitch buttonholes sewn with the Sensor One-Step Buttonhole Foot.

Corded Buttonhole

Corded buttonholes are recommended when sewing buttonholes on stretch medium or stretch heavy fabric. Use gimp threads for a more stable durable and professional appearance. Use pearl cotton or a regular gimp thread. Attach the buttonhole foot C and use the finger on the back of the foot for holding the cord when sewing.

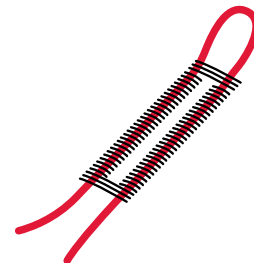

Programmable Button Sew On

Sew buttons, snaps, hooks and eyes quickly with your machine. Select sew on button in the JoyOS ADVISOR™ feature.

Note: Place the thin end of the multipurpose tool under the button when sewing on light fabrics. Use the thick end for heavier fabrics. Hold in place on the fabric with transparent tape.

Note: The recommended width of 3.0 is set for most buttons. If you sew a tiny button or a very large coat button, decrease (–) or increase (+) the stitch width until the swing of the needle sews in the holes of the button or snap.

Note: An optional Button Foot for sewing on buttons can be purchased at your local authorized dealer.

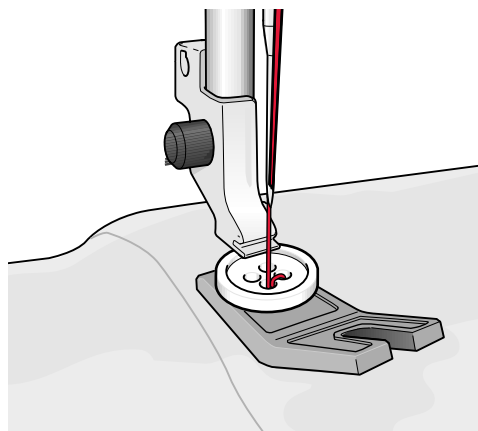

Dimensional Stitches – Menu L

Menu L – dimensional stitches includes three types of stitches: appliqué, pop-up and sequin stitches. In this menu there will also be combined appliqué and pop-up stitches. Since every stitch is unique, these stitches will give different decorative effects depending on which stitch is selected and what type of fabric you have chosen.

Tip: We recommend you to use your JoyOS ADVISOR™ feature and locate the dimensional stitches project for instructions on how to sew dimensional stitches and automatically get the correct settings.

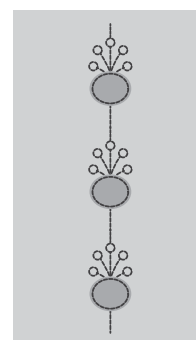

Example of appliqué stitch

Theme Stitches – Menu M

Theme stitches are beautiful combined stitches, in a group of four, designed to be sewn out together in a random combination. Touch the reverse button on the front of your machine or the reverse button on the screen to change to the next stitch in the group. If you touch the reverse button twice – quickly – you will skip the next stitch in the group.

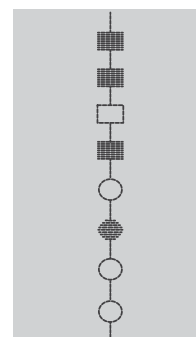

Example of theme stitch



Reverse button on the screen

Embellished Stitches – Menu N

Embellished stitches are decorative stitches where you can change the appearance of the stitch after it is sewn for a special effect. These stitches can be decorated with crystals or cut for a tassel effect.

Tassel stitches are sewn with many threads on top of each other. The threads can either be left as they are sewn or cut to create a 3D effect. The long stitches should be cut at the very edge and from the top side of the fabric. To make the cutting easy, use a seam ripper.

Tip: For heavier threads, use the optional Specialty Candlewicking Foot (part number 413 16 23-45) for easier feeding.

Crystal stitches could either be used as they are or be embellished with crystals in the sewn circles.

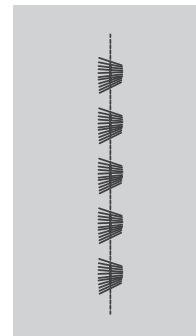

Example of tassel stitch

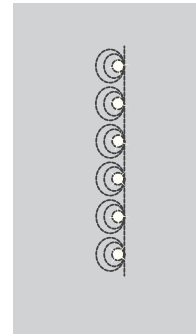

Example of crystal stitch

Tapering Stitches – Menu Q

The tapering menu will be visible when a stitch that can be tapered is selected. Touch the tapering menu to select from different angles for beginning and end tapers. The machine will sew the beginning tapered point and then continue with the selected stitch. When the desired length has been sewn, touch the reverse button. The stitch will taper to the end.

Select taper “off” to remove any tapering at the beginning or end of the stitch. If you select taper “off” on both the beginning and end, the stitch will be a regular stitch without tapering.



Taper Satin Stitch Exercise

The taper stitch automatically tapers the satin stitch for corners and points and can be used for satin stitch lettering. Try the satin stitch exercise and stitch a corner of the tapered satin stitch on a piece of stabilized fabric.

1. Select stitch Q1 in menu Q - Decorative tapering stitches.
2. Open tapering and select 45 degrees for both beginning and end.

Note: For a wider satin stitch, adjust the stitch width control.

3. Activate needle stop up/down on your machine and start to sew. The machine will sew the tapered point and then continue with a satin stitch at the selected width.
4. When the satin stitch is as long as desired, touch the reverse button. This will start the end tapering.
5. Turn your fabric to continue with the next tapered satin stitch. Activate the STOP function to repeat the previously stitched length, including the beginning and end tapers.

4-Way Stitches – Menu S

The 4-way stitch allows you to sew several sturdy stitches in four different directions. You will have different 4-way stitches to choose from. This is especially helpful when patching trouser legs on a free arm. The 4-way stitches are programmed at a fixed length and stitch width.

4-Way Stitches Exercise

Fabric: Woven heavy, two pieces, one a patch.

Select: Woven heavy on your JoyOS ADVISOR™ feature, menu S – 4-way stitches, stitch 8.

Use: Presser foot S and size 90 needle as recommended.

Sew:

1. Place the patch on the larger piece of fabric and position the top left corner of the patch under the presser foot. The machine will sew across the top from the left to the right as shown on the screen.
2. Sew across the top and touch the reverse button or the 4-way sewing direction button (reverse button on the screen) to change the sewing direction. The direction of the stitch on the screen will change. Step on the foot control. The presser foot lowers automatically.
3. Sew down the side of the patch. Continue sewing around the patch, touching the reverse button or the 4-way sewing direction button on the screen, to change the sewing direction.
4. Touch the cut function.

Tip: To sew beautiful corners with 4-way stitches, touch the STOP function before changing the sewing direction. This will complete the current stitch before changing the direction.



4-way sewing direction button (reverse button on the screen)

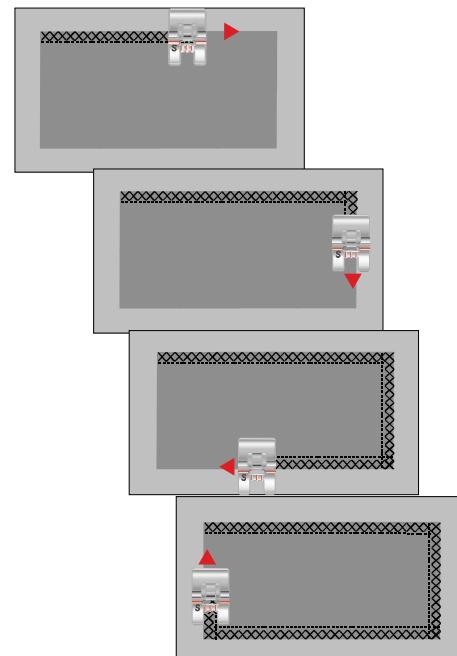

8-Way Stitches – Menu T

There are two different stitches, straight and reinforced straight stitch, in the T menu. Touch the arrows to select one of the pre-set sewing directions. To fine tune the direction of the stitch, use the stitch width and stitch length controls. Program these stitches alone or with decorative stitches from other menus to create unique stitches or borders.

8-Way Stitches Exercise

Fabric: Woven medium and stabilizer.

Select: Woven medium on your JoyOS ADVISOR™ feature, menu T - 8-way stitches.

Use: Thread your machine with embroidery thread on top and bobbin thread in the bobbin. Use presser foot S and size 80 needle as recommended.

Sew:

1. Touch the program button.
2. Select stitch 1 in menu H - children stitches.
3. Select T menu and click 3 times on the straight stitch to the right.
4. Select stitch 1 in menu H.
5. Select T menu and click 3 times on the straight stitch to the right.
6. Select stitch 1 in menu H.
7. Select T menu and click 3 times on the straight stitch to the left.
8. Select stitch 1 in menu H.
9. Select T menu and click 3 times on the straight stitch to the left.
10. Touch OK to enter sewing mode again.
11. Place the fabric and stabilizer in position under the presser foot. Press the foot control to lower the presser foot and start sewing your programmed stitch.

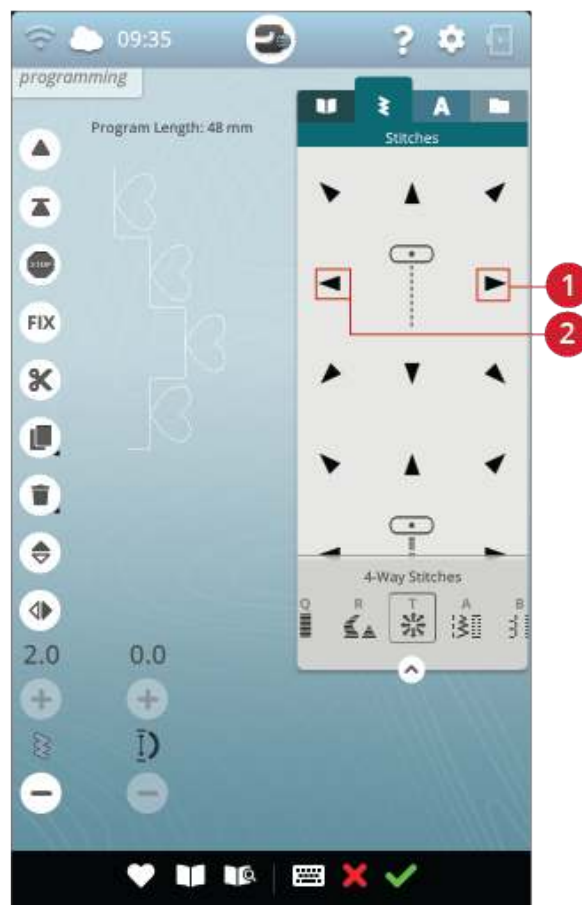

1. Straight stitch right

2. Straight stitch left

Special Stitches For Optional Presser Feet

Stitch menu P- specialty stitches, includes special stitches like candlewicking and edge stitches. These techniques may require special presser feet and accessories. This is indicated by the optional presser foot icon on the screen.

Tip: Detailed information on the current selected stitch is shown in the stitch information.



Sewing Pop-up Messages

Bobbin Thread Low

When the bobbin thread is running low, a pop-up message appears giving you notice that you will soon need to change the bobbin. This gives you an opportunity to plan when you want to change your bobbin. If you want to continue sewing without changing the bobbin, touch the foot control and do not close the pop-up.

Check Upper Thread

The machine stops automatically if the upper thread runs out or breaks. Re-thread the upper thread, close the pop-up message and start sewing.

Remove Sensor One-Step Buttonhole Foot

The Sensor One-Step Buttonhole Foot is used only for buttonholes. A pop-up message will advise you to remove the foot for all other sewing.

Cannot Use the Automatic Needle Threader

If using a twin needle, touch OK and thread it manually. If using a regular needle, touch OK and deselect twin needle in the settings. Press the automatic needle threader button again.

Twin Needle

A pop-up message will appear when you choose a stitch not suitable for twin needle.

Stitch Width Safety

When stitch width safety is activated, a pop-up message will appear when you choose a stitch not suitable for stitch width safety.

Attention!

If the machine stops and this pop-up appears on the screen you need to stop sewing. Wait a moment and touch the OK button when it is enabled. Check the needle size and condition. Check for correct threading.

8 Embroidery Edit

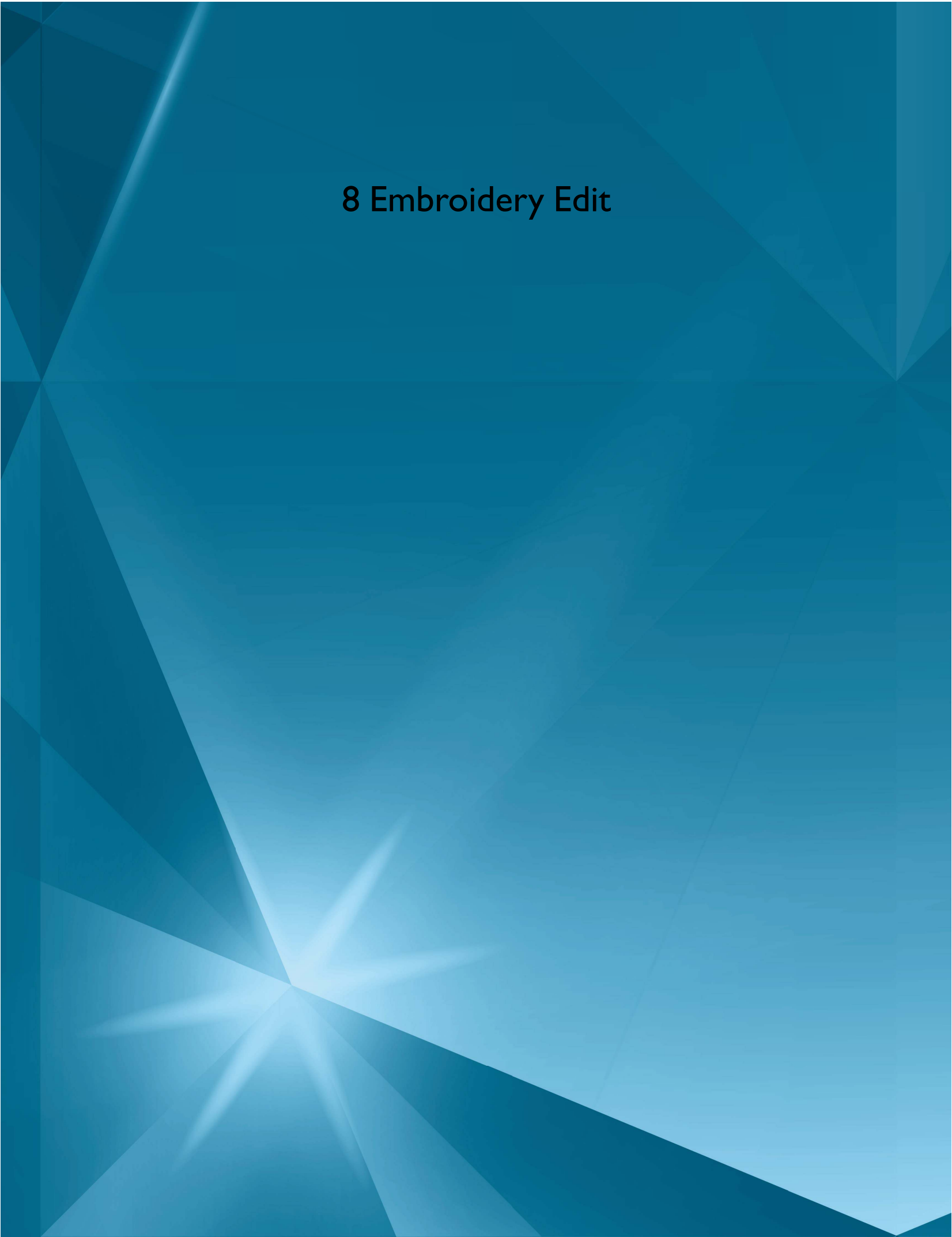

Getting Started to Embroider

When your DESIGNER SAPPHIRE™ 85 machine starts the home screen will be opened automatically.

Select a special embroidery technique or touch start new.

When a special embroidery technique is chosen you will have directions from the JoyOS ADVISOR™ feature. When you touch start new you will enter embroidery mode.

Read more about the JoyOS ADVISOR™ feature.

Embroidery Edit – Overview

In embroidery edit you can adjust, combine, save and delete designs, stitches and fonts. You can edit your design combinations without having the embroidery unit connected to your machine. The loaded design(s) are shown in the embroidery area.

Tip: Minimize the selection area by touching the minimize selection area to use the whole screen when editing your design combinations.

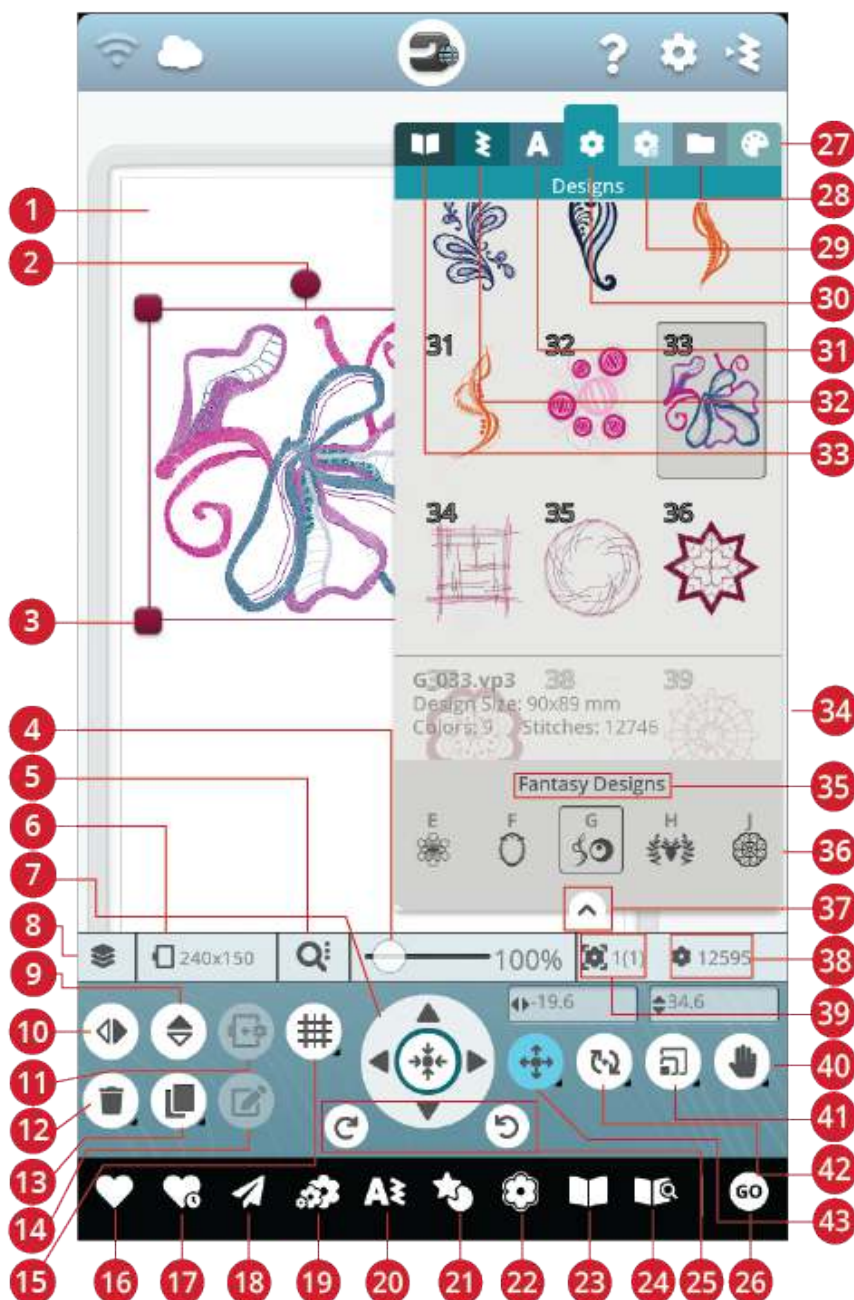

- | | | |
|--------------------|---------------------------|-----------------------------------|
| 1. Embroidery area | 9. Mirror end to end | 17. Smart save |
| 2. Rotate handle | 10. Mirror side to side | 18. Send design |
| 3. Scale handles | 11. Move to hoop | 19. Resize |
| 4. Zoom slider | 12. Delete | 20. Program |
| 5. Zoom options | 13. Duplicate | 21. Design shaping |
| 6. Hoop selection | 14. Edit | 22. Design appliqué |
| 7. Control wheel | 15. Grid/background color | 23. JoyOS ADVISOR™ project viewer |
| 8. Arrange | 16. Save | 24. User's guide |

- 25. Undo/Redo
- 26. Go to embroidery stitch out
- 27. Thread color edit
- 28. File manager
- 29. *mySenmel*[™] library menu
- 30. Design menu
- 31. Font menu
- 32. Stitch menu
- 33. JoyOS ADVISOR[™] project menu
- 34. Design information
- 35. Design menu name
- 36. Design categories
- 37. Minimize selection area
- 38. Total number of stitches in design combination
- 39. Design stitch out order
- 40. Pan
- 41. Scale
- 42. Rotate
- 43. Position

Grid/Background Color

Touch the grid/background color button to activate a grid on the embroidery area to guide placement of designs. Touch again to remove the grid.

Touch & hold to set background color and/or grid options.

Background color

Select a background color for the embroidery area that matches the color of the fabric you will use. Choose between different background colors. The selected background color will be shown in the hoop.



Alignment

If activated, guides will appear when moving your design around the screen. This will help you to easier line-up two designs to one another.

Grid options

Touch and hold the grid options button to set the distance between the grid lines in millimeters/inches using the - and + buttons. You can also choose from 8 predefined grid options. Alternatively touch in the grid number area to open a keypad where you can enter a number.

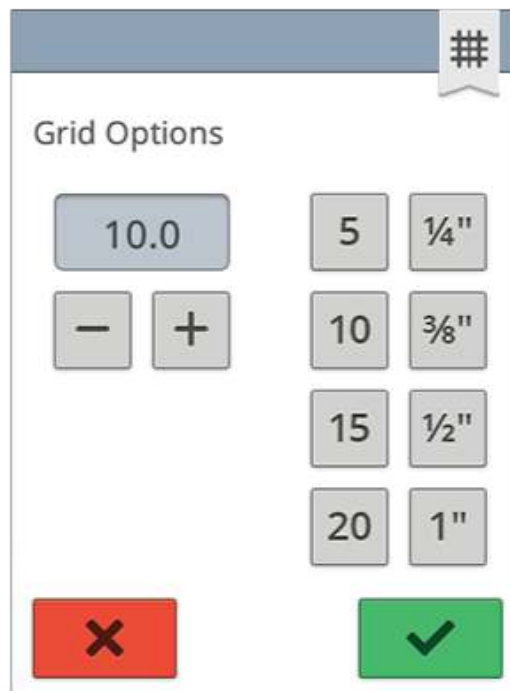

mySewnet™ Library

mySewnet™ library is a subscription service where you can get access to thousands of embroidery designs. Visit library.mysewnet.com to read more about this service and start your subscription.

If you have a subscription, WiFi is connected and you have logged in to your *mySewnet™* account, the *mySewnet™* library menu will be visible in your machine. Here you can scroll and select from all your *mySewnet™* library designs.

Use the search function to find different types of designs. There are several ways to filter and sort designs. Filter designs by size by changing the maximum width and/or maximum height. Designs you've marked as favorite designs in *mySewnet™* can also be filtered in your machine if you touch the favorite designs button.

You can also sort the designs by color block count, size (area) or stitch count. Touch the sort from button to sort from highest to lowest value. Touch the sort from button again to sort from lowest to highest value instead.

To remove all applied filters and clear your search, touch reset.

If you haven't started a subscription yet, the *mySewnet™* library menu will still be visible in your machine, but no designs in this menu will be shown.

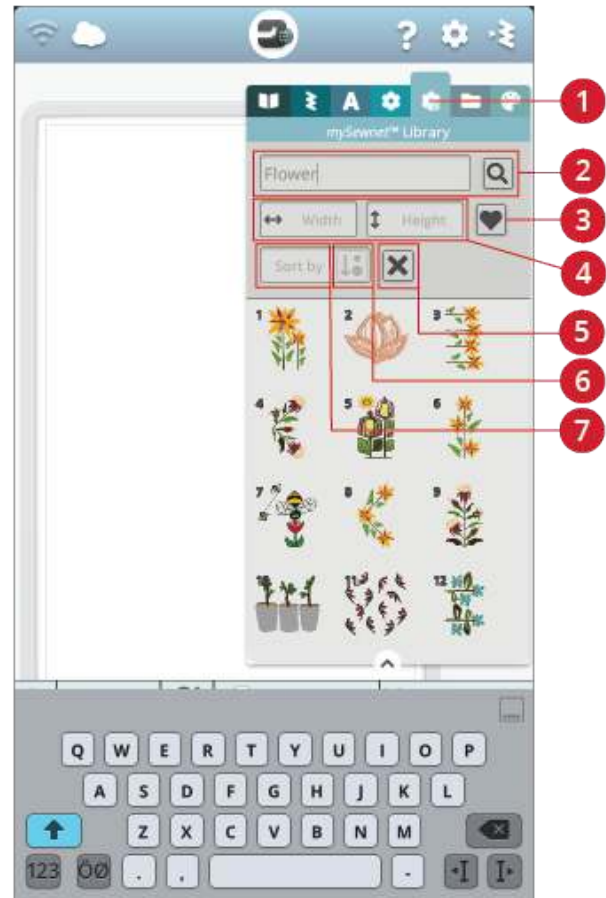

1. *mySewnet™* library menu
2. Search
3. Favorite designs
4. Filter by width/height
5. Reset
6. Sort from
7. Sort by

Load a Design

Touch & hold a design for a few seconds to activate it and then drag the design to the embroidery area without releasing your finger from the screen. To place the design, release your finger from the screen and the design will be placed into the embroidery area.

Swipe up/down in the selection area to scroll through the designs within the selected category. When you are in the design menu you can swipe left/right in the selection area to scroll to and select a different design category. Alternatively swipe left/right in the category list and touch a category to select it. When a design is selected, information about the design will be shown.

Note: You can also load saved designs from the mySewnet™ cloud folder and from a USB device in file manager.



Load a Stitch

Touch & hold a stitch from the stitch menu for a few seconds to activate it and then drag the stitch to the embroidery area without releasing your finger from the screen. To place the stitch, release your finger from the screen and the stitch will be placed into the embroidery area.

Note: You can also load saved stitches from the mySewnet™ cloud folder and from a USB device in file manager.

Note: Touch a stitch to get information about the selected stitch.



Load a Font

Text can be created both with embroidery fonts and stitch fonts. Select a font by opening the font menu and touching your desired font on the screen. If you choose an embroidery font, the program embroidery text window will open. If you choose a stitch font it will be loaded to program. Stitch fonts are shown in black while embroidery fonts are shown in color. The created text will then be loaded into the embroidery area. If you want to edit your text, select your text and touch the edit design button or use the smart toolbox.

Note: You can also load saved fonts from the mySewnet™ cloud folder and from a USB device in file manager.



File Manager

Touch the file manager button to open file manager and locate your saved design, stitch or font. In file manager you can load files from the mySewnet™ cloud folder, built-in designs and from a USB device. Touch & hold to load a design, stitch or font. To load several designs, stitches and/or fonts, activate multi-select and select your files. Touch & hold on one of the selected files to load all selected files into the embroidery area.

Read more about organizing your saved designs, stitches and fonts in file manager.



How to Select Designs

When loading designs into embroidery edit, the last loaded design is selected by default.

Select One Design

To select one design you can either touch the design on the screen or open arrange and touch the thumbnail image in the selection window. To see the order your designs will be embroidered, read about design stitch out order.

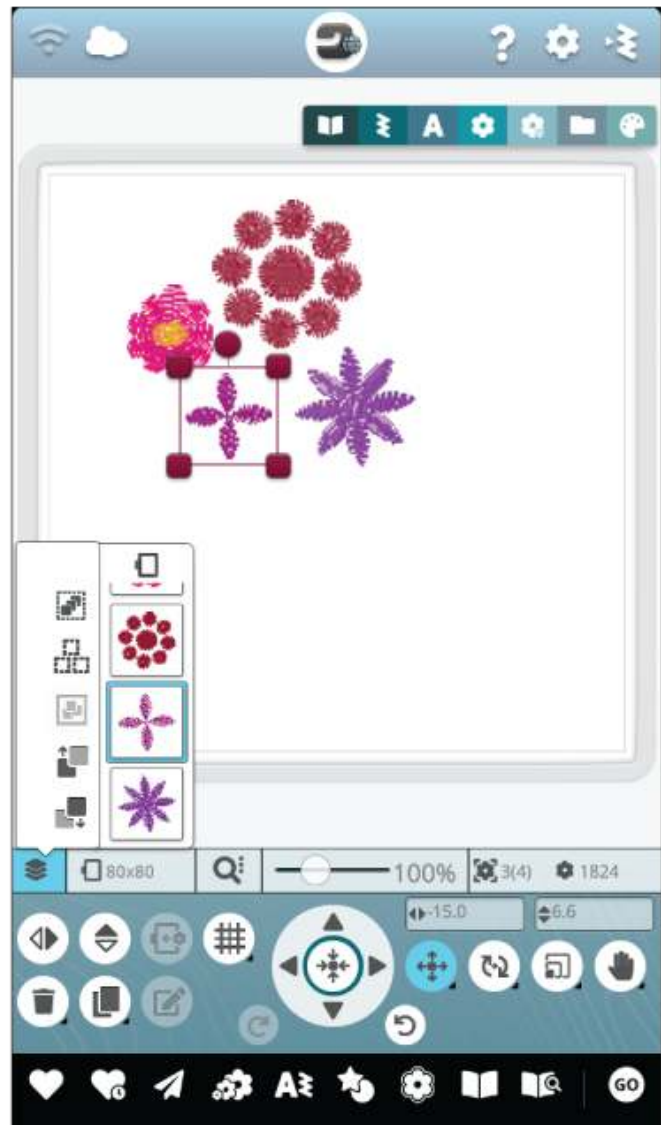

Select Design Exercise

1. In embroidery edit, touch the design menu.
2. Touch & hold a design in the design menu to activate it, then drag to the embroidery area and release to load it. Do this four times with different designs.
3. The last design will be surrounded with a design selection frame which means that it is selected.
4. If you want to select the first design you inserted, touch the design on the screen. Alternatively touch arrange and select the thumbnail image for the first design in the selection window.
5. To select more than one design, touch the multi-select button. Touch the designs you want to select.
6. Once you have selected the design(s), you can delete, duplicate, position, scale, mirror and/or rotate them. Only the design(s) that are selected will be affected by your changes.



Select All

7. If you want to select all designs, simply touch the select all button. All designs on your screen will be selected, indicated by a design selection frame. You can now make changes to all designs. If you want to combine all the designs into one design, touch the group/ungroup button.



Hoop Selection

The machine will choose the most suitable hoop for the loaded design. To select a different hoop size, touch the hoop selection button. A list will appear with hoop choices, including hoops that are available to purchase from your authorized HUSQVARNA® VIKING® retailer.

After selecting your hoop size, the list will close automatically.

Note: You can adjust the list by choosing specific hoops in my hoops in default embroidery settings. The selected hoops will be shown at the top in the hoop selection list.

Note: In the hoop list you will find that some hoop sizes are followed by a letter. These are specialty hoops. For example, E stands for endless hoop, T for texture hoop and M for metal hoop.

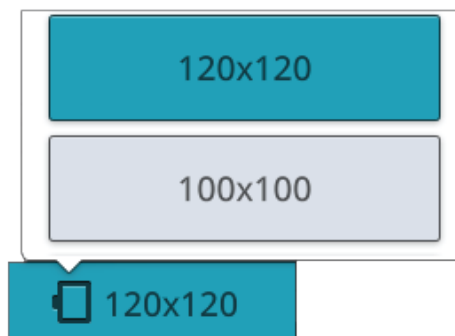

Arrange

Touch the arrange button to find several functions that will help you arrange the stitch out order of your designs.

Touch the button again to close.



Arrange button

Multi-Select

Multi-select allows you to select two or more of the designs on your screen at the same time. Touch the multi-select button and then touch the designs on the screen you want to select. Alternatively select the thumbnail pictures in the selection window. A design selection frame will surround the selected designs; both the thumbnail pictures in the selection window and the designs in the embroidery area. To deselect, touch the designs again and the design selection frame will disappear.



Select All

If you want to select all designs, simply touch the select all button. All designs on your screen will be surrounded by design selection frames. You can now make changes to all of the selected designs. If you want to combine all the designs into one design, touch group/ungroup button.



Group/Ungroup

If you have selected two or more designs and want to combine them to be adjusted as one design, touch the group/ungroup button. A design selection frame will surround each design that is selected and, when grouped, the design selection frame will surround all of the designs in the group. To ungroup, touch the group/ungroup button again and they will once again become individual designs.



Stitch Out Design Before/After

To change the design stitch out order without having to start over and load the designs again, you can use the stitch out design before/after buttons. Select the design you wish to stitch out before/after and touch one of the buttons to change the design order. The design will move in the selection window to show the changed stitch out order. Read more about design stitch out order.



1. Stitch out design before

2. Stitch out design after

Edit Functions

Move to Hoop

A red frame will surround the embroidery area if a design is placed outside the hoop area. Touch move to hoop to move any design that is outside the hoop area into the hoop area. The design will be placed at the outermost edge of the hoop.

Tip: If you want to place a design e.g. in the top left corner as near as possible easily, touch and drag your design to the top left corner. Make sure that the design is placed outside the hoop area. Touch move to hoop and the design will be placed at the top left corner of the hoop area, as close to the hoop edge as possible.



Delete

When you touch delete, the selected design(s) will be deleted from the embroidery area. If more than one design is selected, a pop-up message will appear. Touch OK to confirm to delete all designs. Touch & hold to delete all loaded designs from the embroidery area and touch OK in the pop-up window to confirm.



Duplicate

Touch duplicate to make a copy of the selected design(s). Touch & hold on the duplicate button to add more than one copy of the selected design(s). A keypad will appear on the screen where you can enter the desired number of copies.



Mirror Side to Side and End to End

To mirror a design horizontally, touch the mirror side to side button. To mirror vertically, touch the mirror end to end button.



1. Mirror side to side
2. Mirror end to end

Touch Functions

You can position, rotate, scale and pan directly on the multi-touch screen using your fingers. Touch & hold on a touch function to lock it. A padlock below the button indicates that the function is locked. This will prevent activation of another touch function by mistake when working with your design(s) directly on the multi-touch screen. Select any touch function to unlock.



Touch function pan is locked

Position

Touch and move a selected design with your finger to position it anywhere in the embroidery area. The touch function, position, will automatically be activated.

Use the wheel to adjust the position of the selected design(s). The numbers above the position button show, in millimeters/inches, the horizontal and vertical distance from the center of the hoop for the selected design(s). Touch in the number field to enter a custom value. If an invalid value is entered, the color of the numbers will change.

Touch the center of the control wheel to position the selected design(s) in the center of the hoop.



Rotate

Touch and move the round handle to rotate the selected design(s).

Use the wheel arrows to adjust the rotation of the selected design(s) in one degree increments. Each touch in the center of the control wheel will rotate the selected design(s) 90 degrees clockwise. The number above the rotate button shows, in degrees, the current rotation angle. Touch in the number field to enter a custom value. If an invalid value is entered, the color of the numbers will change.

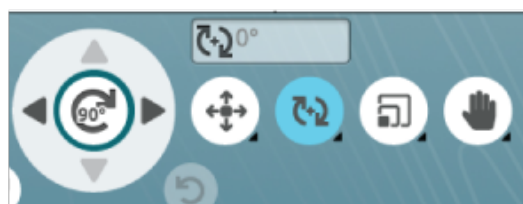

Scale

With the touch function, scale, you can increase or decrease the size of the selected design(s) up to +/- 20% without changing the number of stitches.

Note: To increase or decrease a design more than 20%, use the resize function.

Scale the selected design(s) by touching one of the scale handles in the corners of the design selection frame and move your finger on the screen. The touch function, scale, will automatically be activated. When scaling a design the 100% button will be enabled. Touch the button to scale the design to the default size.

Touch in the number field to enter a custom value. If an invalid value is entered, the color of the numbers will change.

Use the wheel arrows to adjust the size of the selected design(s). The numbers above the scale button show, in millimeters/inches, the current width and height.

By default the proportions are locked. This is indicated with a closed padlock in the center of the control wheel. Touch the padlock in the center of the control wheel to unlock and activate individual scaling of width and height.

Note: In design shaping and design appliqué the numbers above the touch function scale, relate to the shape line and not the shape/appliqué design.



Pan

Touch and move anywhere in the embroidery area, except on a selected design, to pan the embroidery area in zoomed view. If you touch and move on a selected design this will activate the position function and you will move the design instead of panning the embroidery area.

Touch & hold to lock pan and prevent activation of position by mistake. A padlock and a magnifying glass below the button indicates that the function is locked. You can now only pan and zoom. Select any touch function to unlock.

You can also use the control wheel to adjust the view of the embroidery area.



Zoom

Zoom in by touching with two fingers at the same time on the screen and, without releasing, increase the distance between the fingers to stretch. Zoom out by touching with two fingers at the same time on the screen and, without releasing, reduce the distance between the fingers to pinch.

If you zoom on a selected design, this will activate the position function and move the design instead of zooming. Touch and hold to lock pan and prevent activating position by mistake. A padlock below the button indicates that the function is locked. You can now only pan and zoom. Select the button again to unlock.

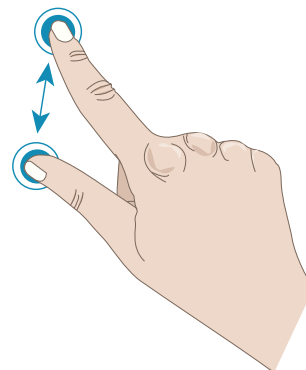

Alternatively use the zoom slider to zoom in and out in the embroidery area. Move the slider to the right to zoom in and to the left to zoom out. You will see how much you have zoomed to the right of the slider.

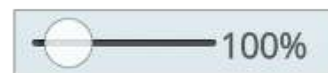

Zoom Options

Touch zoom options to open a pop-up where you can choose between zoom to all or zoom to hoop. Zoom to all will show all the design(s) in the embroidery combination. Zoom to hoop will adjust the embroidery area to fit the selected hoop.



1. Zoom to all
2. Zoom to hoop

Undo/Redo

Touch the arrow pointing left to undo your latest design adjustment. Touch repeatedly to step back through your adjustments.

Touch the arrow pointing right to redo your latest design adjustment. Touch repeatedly to step forward through your adjustments. Redo is only activated when undo has been touched.

Note: Not all adjustments can be undone. The buttons will be greyed out if undo/redo are not possible.



1. Undo
2. Redo

Design Stitch Out Order

When working with a design combination that consists of several designs it can be useful to know in which order they will be stitched out. Select a design to see which stitch out number it is. 3(4) for example means that the selected design is the third out of four designs to be stitched out.



Total Number of Stitches in Design Combination

You can see the total stitches in your design combination next to the flower in embroidery edit.



Save Design

To save your file, touch the save button. You can choose to save the file to the *mySewnet*[™] cloud folder or to a USB device. Previously saved designs, stitches, programs and/or fonts are shown. Name your file and touch the OK button to confirm.

If you want to save to a folder, simply touch & hold on the folder to open it, then name your file and touch OK to save. To create a new folder, simply touch the create new folder button, name the folder and touch OK. Then touch & hold on the folder to open it and save into the new folder.

Touch the list and thumbnail view button to toggle between showing the files in a list or as thumbnail icons.

To cancel the save process, close the pop-up window by touching cancel. The save pop-up will close and you will return to embroidery mode.

Read more about organizing your saved files in file manager.



Save button in embroidery edit

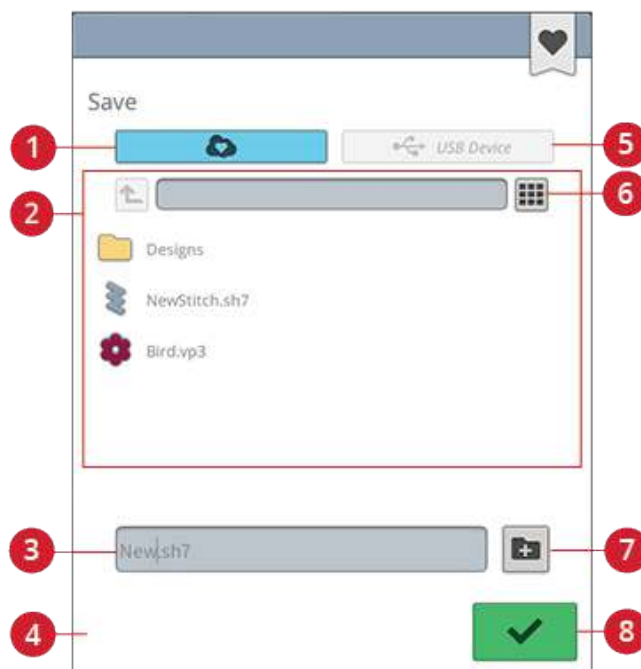

- | | |
|--|---|
| 1. Save to the <i>mySewnet</i> [™] cloud folder | 5. Save to a USB device folder |
| 2. Selection area | 6. Toggle between list and thumbnail view |
| 3. File name | 7. Create new folder |
| 4. Cancel | 8. Ok |

Smart Save

If you want to stop sewing and save your current design(s) and settings, touch the smart save button. A pop-up will indicate that a smart save has been done and you can now turn off the machine.

Smart save remembers and stores the stitch, embroidery and settings as they were when smart save was last performed. This makes it possible to turn off your machine and continue sewing later. To load smart save, touch the load smart save button in the home screen.

Your smart save will be saved until you touch the smart save button again and replace it.



Home screen button



Load smart save button

Send Design

Send selected embroidery designs directly to other *mySewnet™* enabled devices. Choose any of the available devices by touching it. The pop-up closes and the selected design(s) are sent.

Note: You can only send designs to devices connected to the same mySewnet™ cloud account.



GO

To proceed to embroidery stitch out, touch GO. A “welcome to embroidery stitch out” window will appear. In this window you will get an overview of your current embroidery settings before you continue. Review the settings before you proceed.



Edit an Existing Design or Text

When you have created a design, e.g. a shape, appliqué or text, the edit design button will be active. If you want to edit the design that you have created, select your design and touch the edit design button. Depending on the type of design that is selected, you will enter different windows. For example, if selecting a shaped design, you will enter the design shaping window with the selected design loaded for editing.

Tip: Edit function will also be found in the smart toolbox if available.



Edit Buttonhole

Select a buttonhole and touch the edit button to change stitch width, button size and stitch density. Touch the alternative switch bar to switch to the stitch density controls. Touch OK to confirm the changes.

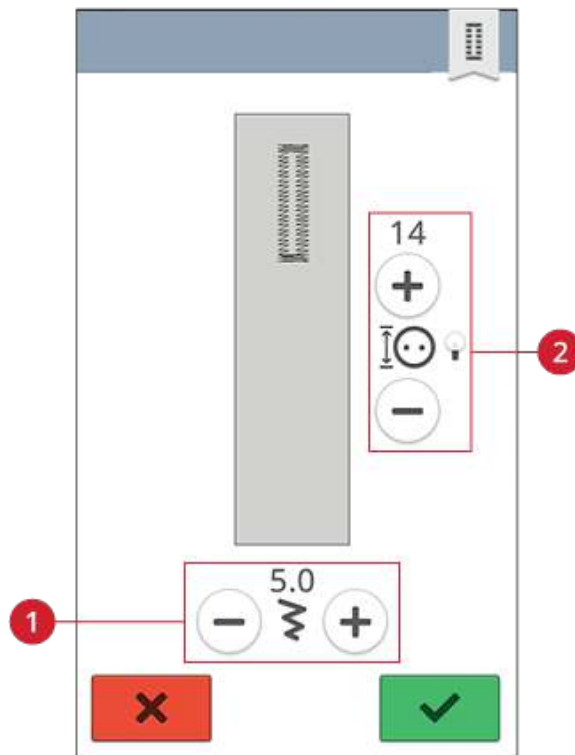

1. Stitch width

2. Button size/stitch density

Thread Color Edit

Touch the thread color edit button to view a list of thread colors in the selected design(s).

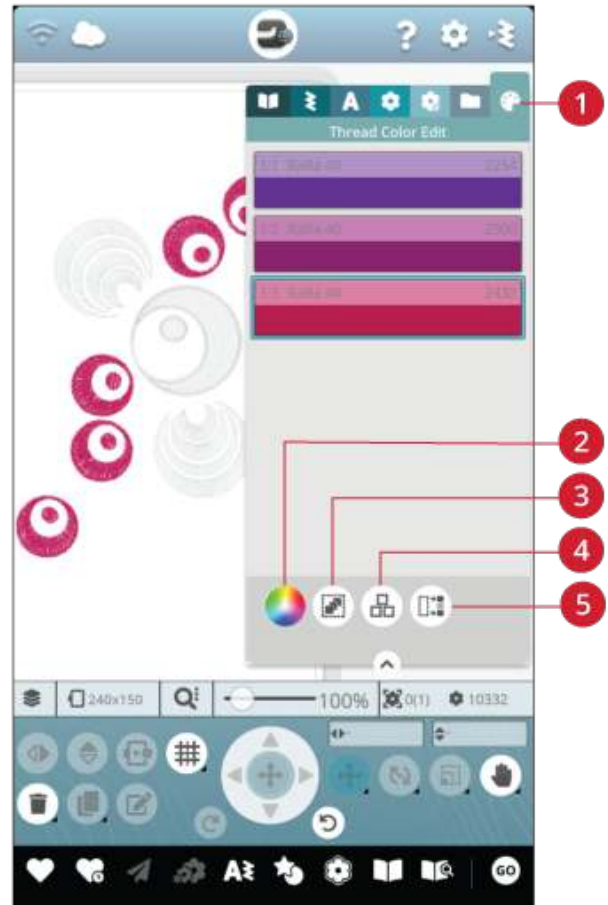

1. Thread color edit
2. Thread color change
3. Select all
4. Multi select
5. Select equal

Thread Color Change

You can edit the colors in your design. Touch the color block in the list that you want to change. Touch the thread color change button to select a new thread color.

Touch on the color wheel to select your new color or touch the gray scale bar. When choosing a color from the color wheel a color lightness bar will appear where you can set the lightness of the current color.

Previous selected colors will be shown. To select any of the previous colors, touch the color.

Change More Than One Color Block

To change the thread color on more than one color block at a time, touch the multi-select button, then touch the color blocks to select the ones you want to change.

Touch the select all button to make changes to all color blocks at one time. The multi-select button is automatically selected.

Use the select equal button to change all the same color blocks at one time. Touch the color block you want to change, then touch the select equal button to select all identical color blocks in the list. The multi-select button is automatically selected. If two or more different color blocks are selected, select equal will select all identical color blocks of all of the selected colors.

On-Screen Display of Selected and Non-Selected Color Blocks

Selected color blocks are shown with their color on the screen. Color blocks that are not selected will be greyed out in the embroidery area on the screen to make it easy to see which color blocks in the design will be changed.

Touch the selected color block to deselect and show all color blocks in the embroidery area again.



Pop-up for thread color change

Program Embroidery Text

To create a text design, touch the font menu and select an embroidery font. Write your text and touch OK when finished to load it into the embroidery area.

When selecting an embroidery font the program embroidery text window will open automatically. If you want to adjust an existing text in embroidery edit, select the text design and touch the edit design button. You can also reach edit via the smart toolbox.

Note: If a stitch font is selected, program will be opened instead when touching the edit button.

Create a Text

Write your text. The text is shown in the embroidery area and in the text area above the keyboard.

You can change the font and the size of the entire text by touching another embroidery font in the font menu. The text that is written will change to the new font and/or font size in the embroidery area.

Add a Letter

Use the cursor arrows to move the cursor to where you want to add a letter into a text. Touch the letter and it will be inserted at the cursor position. You can also touch with your finger in the text area to move the cursor.

Delete a Letter

To delete a letter, place the cursor after the letter. Touch the delete button. If you want to delete all text, touch & hold the delete button. The letters will be deleted one by one, with increasing speed.

Text Shaping

You can shape your written text with different shaping functions.

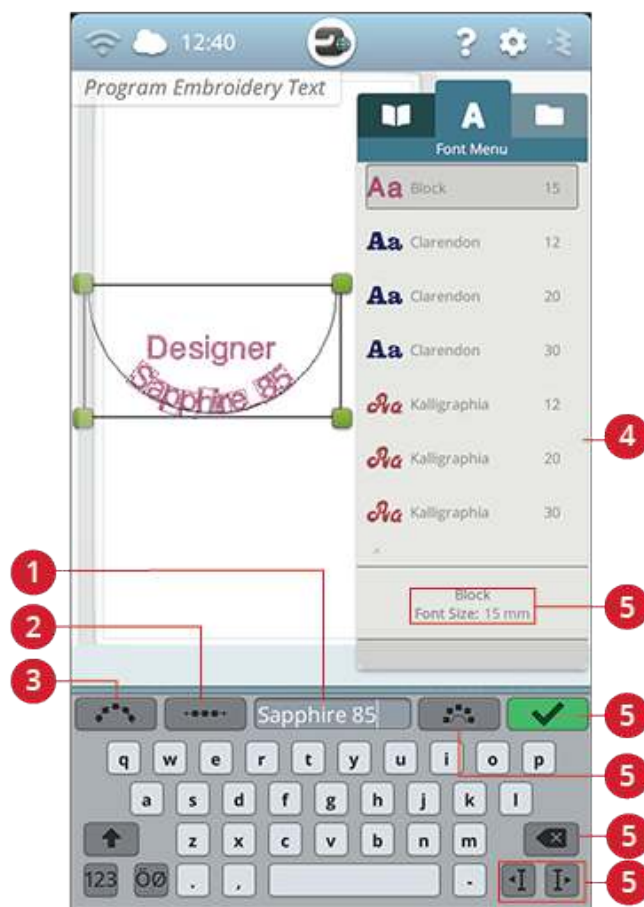

1. Text area
2. Select spacing
3. Select text shape
4. Font menu
5. Selected font information
6. OK, return to embroidery edit
7. Fixed letter angle
8. Delete
9. Cursor arrows

Select Text Shape

Touch select text shape to open a list of different shape line types. Touch a shape line and your text will follow the shape line on the screen. The small black arrow indicates the direction your text will follow when adding letters to the shape line.

To change the size of the shape, touch one of the scale handles in the corners of the design selection frame and drag your finger on the screen.



Select Spacing

Touch the select spacing button to open a list of options for spacing your text along the shape line: evenly spaced, left justified, centered or right justified. Evenly spaced will place the text evenly along the shape line with an equal distance between all letters. If you choose left justified the text will begin loading from the left. Centered will center the text on the shape line. If you choose right justified, the text will begin loading from the right. The distance between each letter can be increased or decreased with the spacing slider, except for when evenly spaced is selected.

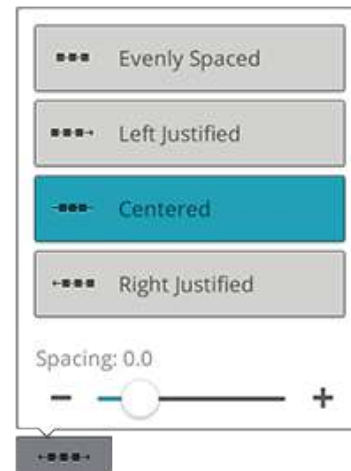

Fixed Letter Angle

Touch the fixed letter angle button to align all the letters in a fixed, vertical rotation on the shape line. Deselect to angle the letters in relation to the shape line.



Design Shaping

Design shaping is a unique way to take your creativity to another level. Use your beautiful stitch programs or embroidery designs to form one of several shapes.

Tip: Use your JoyOS ADVISOR™ feature to locate projects for design shaping instructions.

Design Shaping Exercise

1. Touch the design shaping button in embroidery edit to start a new shape.
2. Touch the shape menu and select one of the shapes in the list. A shape line will be shown on the screen. The small black arrow in the shape menu indicates the direction your designs will follow when adding them onto the shape line.
3. Add designs or stitches onto the shape from the design menu, stitch menu or from file manager. Touch & hold a design or stitch for a few seconds to load and then drag it to the shape line without releasing your finger. Release your finger to place the design or stitch onto the shape line.
4. To change the size of the shape, touch one of the scale handles in the corners of the design selection frame and drag your finger on the screen. The touch function scale will automatically be selected. To rotate your shape, touch and rotate the rotate handle on the multi-touch screen. The touch function rotate will automatically be selected.



Design shaping button

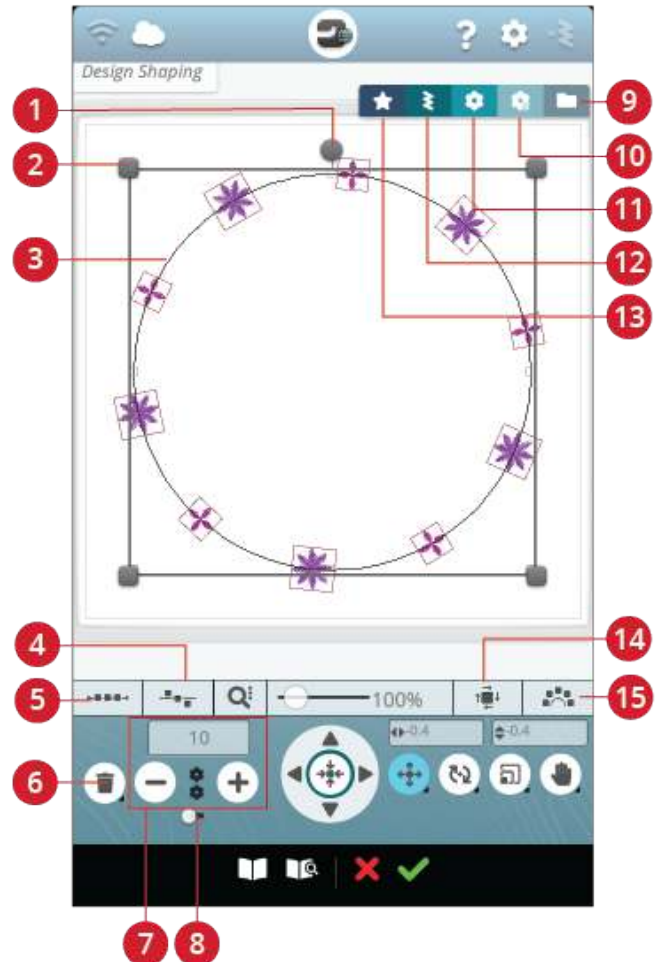

- | | |
|---|-----------------------------|
| 1. Rotate handle | 9. File manager |
| 2. Scale handles | 10. mySewnet™ library |
| 3. Shape line | 11. Design menu |
| 4. Select line positioning | 12. Stitch menu |
| 5. Select spacing | 13. Shape menu |
| 6. Delete last/delete all | 14. Select side positioning |
| 7. Set number of designs | 15. Fixed design angle |
| 8. Combination repeat/ duplicate last design | |

Combination Repeat/Duplicate Last Design

5. Add more designs onto your shape in two different ways with the combination repeat/duplicate last design function. When the slider is set to the right, touching the + button will add designs to the shape in the same order as the ones already loaded. When the slider is set to the left, touching the + button will duplicate the last added design in the shape. Touch in the number area above the + and - buttons to open a keypad to set the number of designs.
6. Touch OK in the design shaping window to load the shaped design to the embroidery edit window.



Combination repeat

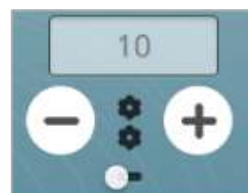

Duplicate last design

Edit Existing Shape

7. If you want to make any changes to an already created shape in embroidery edit, select your shaped design and touch the edit button in embroidery edit. You will now enter the design shaping window again.

Tip: You can also reach edit by opening the smart toolbox. Touch & hold on the shaped design to open smart toolbox.



Select Spacing

Touch the select spacing button to open a list of options for spacing your designs along the shape line: evenly space, left justified, centered or right justified. Evenly spaced is selected by default and will place the designs evenly along the shape line with an equal distance between all designs. If you choose left justified the designs will begin loading from the left. Centered will center the designs on the shape line. If you choose right justified, the designs will begin loading from the right. The distance between each design can be increased or decreased with the spacing slider, except for when evenly spaced is selected.

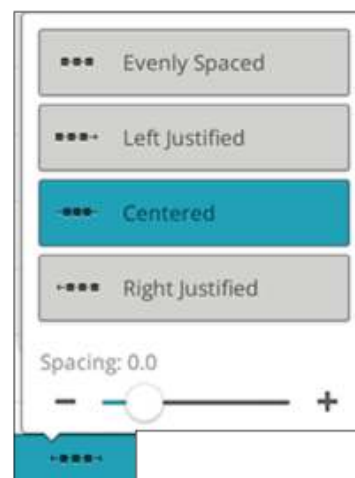

Select Line Positioning

Touch the select line positioning button to open a list of options for placing your designs horizontally, relative to the shape line: above, centered or below.

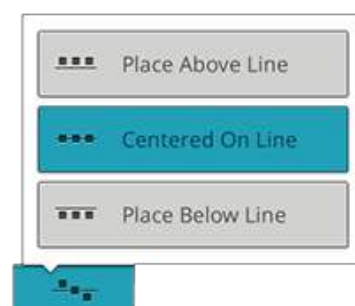

Select Side Positioning

Touch the select side positioning button to open a list of options for how the designs will be rotated on the shape line: no rotation, rotate 90 degrees clockwise, rotate 180 degrees or rotate 90 degrees counter-clockwise.

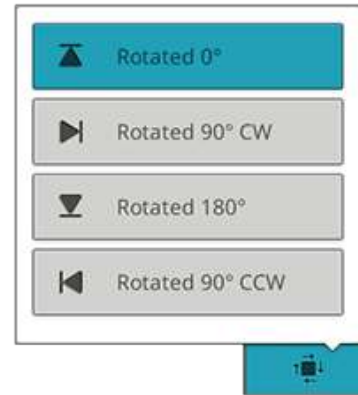

Fixed Design Angle

Touch the select design angle to align all the designs in a fixed, vertical rotation on the shape line. Deselect to keep the current angle along the shape line.



Set Number of Designs

If you want to enter the total number of designs you want in your shape, touch in the number area above the + and - buttons to open a keypad. Enter the desired number of designs and touch OK to close.



Design Appliqué

Create a decorative appliqué with the design appliqué feature. Touch the design appliqué button in embroidery edit to start a new appliqué design.

Tip: We recommend to use your JoyOS ADVISOR™ feature for instructions on how to create an appliqué.

When creating your appliqué design there are three different decorative stitches with two different widths to choose from to finish the edge of the appliqué:

- Satin stitch (narrow or wide) – A narrow or wide satin stitch will be placed around your appliqué shape.
- Feathered stitch (narrow or wide) – A narrow or wide feathered stitch will be placed around your appliqué shape.
- Candlewicking stitch (narrow or wide) – A narrow or wide candlewicking stitch will be placed around your appliqué shape.

The decorative stitches will cover the raw edges of the appliqué.

Design Appliqué Exercise

1. Touch the design appliqué button in embroidery edit to start a new appliqué. To the right, in the shape menu, you will find different shapes, letters and numbers to choose from when creating your appliqué design. Touch a shape to load it.
2. Touch one of the decorative stitches to load it to the shape line.
3. To change the size of the appliqué design, touch one of the scale handles in the corners of the design selection frame and move your finger on the screen. The touch function scale will automatically be selected. To rotate your shape, touch the rotate handle on the screen. The touch function rotate will automatically be selected.
4. Touch OK to confirm your design appliqué and load to the embroidery edit window. Touch GO to enter embroidery stitch out.

Stitch Out

5. The first color block will sew a straight stitch outline on the base fabric to show where the appliqué will be sewn.
6. Place your appliqué fabric over the outline stitch on the base fabric. Make sure that your appliqué fabric covers the outline.
7. The second color block will sew another straight stitch to secure the appliqué fabric to the base fabric.
8. Trim excess appliqué fabric as close to the stitching line as possible.
9. The stitches in color block three will cover the raw edges of your appliqué.



Design appliqué button

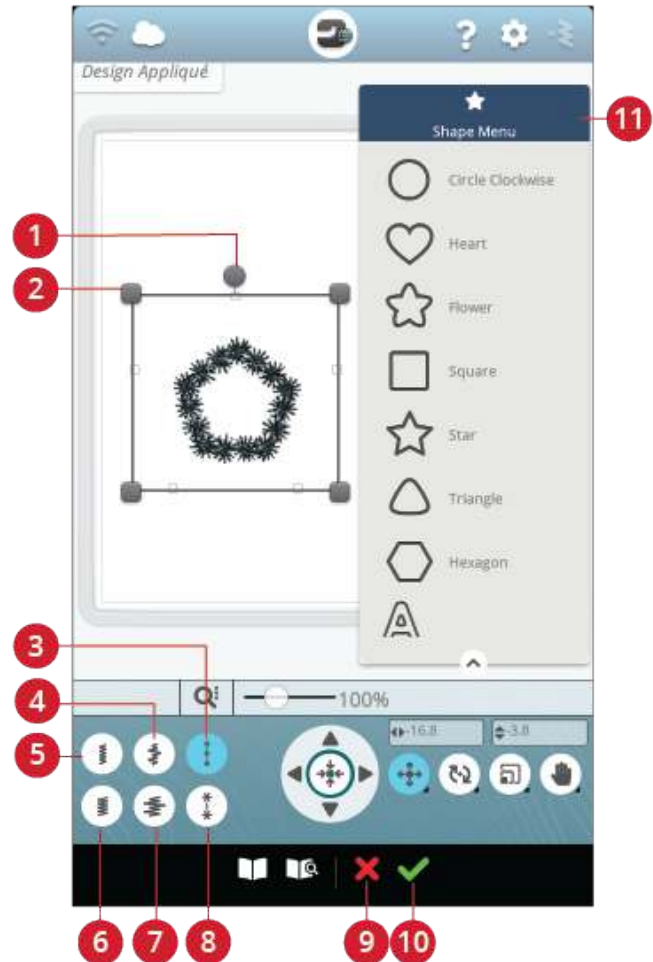

- | | |
|------------------------------------|--------------------------------------|
| 1. Rotate handle | 7. Feathered satin stitch (wide) |
| 2. Scale handles | 8. Candlewicking stitch (wide) |
| 3. Candlewicking stitch (narrow) | 9. Cancel, return to embroidery edit |
| 4. Feathered satin stitch (narrow) | 10. OK, return to embroidery edit |
| 5. Satin stitch (narrow) | 11. Shape menu |
| 6. Satin stitch (wide) | |

Resize

Resize can reduce an embroidery design up to five times smaller than the original design or increase it up to eight times larger than the original design. The machine recalculates the number of stitches in the design so the original stitch density remains. Touch the resize button to open the resize window.



Note: To reduce or increase the design less than 20%, use the scale function. The scale function does not change the stitch count.

Resize Adjustments

To change the size of the design, touch one of the resize handles in the corners of the design selection frame and move your finger on the screen. The touch function resize will automatically be selected. When resizing, the height and width of the design is always adjusted proportionally. The numbers above the resize button show the current width and height in millimeters/inches. Fine tune with the control arrows.

When resizing a design the 100% button will be enabled. Touch the button to return to the original size.

Touch & hold the resize button to lock it and prevent activation of another touch function by mistake. A padlock below the button indicates that the function is locked. Select any touch function to unlock.

Adjust the placement of the design in the hoop using position and/or rotate.

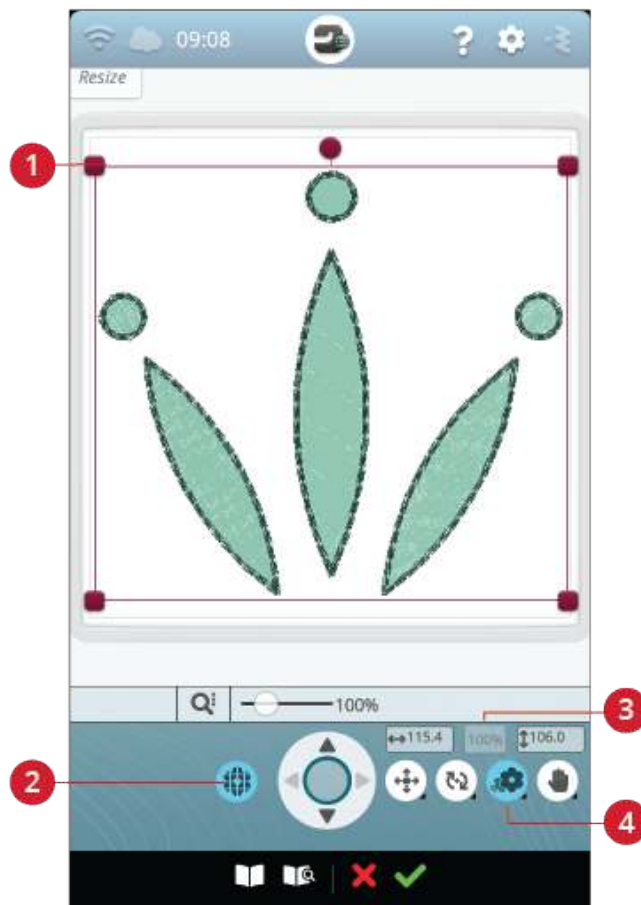

1. Resize handles
2. Retain fill type
3. Return to original size
4. Resize

Retain Fill Type

All fill areas in an embroidery design are made in a specific fill type to achieve the best results. When enlarging or reducing a design, the stitches in the fill area will be affected. The retain fill type function is selected by default, this will keep the fill types as they were originally created.

Retain fill type gives the best result in most cases. If your design becomes distorted, try resizing without retaining the fill type. Reload the original design, deselect retain fill type and resize your design again.

Start Resizing

When you are satisfied with the design size and position, touch OK. The resize window will close and your resized design is loaded to the embroidery edit window.

Touch cancel to return to embroidery edit without resizing.

Note: Stitches and stitch programs cannot be resized.

Important Resize Information

Since designs are digitized for a specific design size, it is important to consider the following information about resize. Always embroider a test sample of your resized design before embroidering on a project.

- | |
|---|
| <ul style="list-style-type: none">• Resize is always proportional. If you reduce a design 30%, it will be 30% smaller in both length and width. If the design is very detailed, some of it may be lost or distorted, and/or it can become very dense. Some designs, especially those with lots of detail, should not be reduced more than 25%. |
| <ul style="list-style-type: none">• Designs can be resized larger than the selected hoop. After resizing, make sure the design fits or select a larger hoop for the machine to be able to embroider it. |
| <ul style="list-style-type: none">• If you enlarge a design too much, you may see stitch irregularities. Press the 100% button to return to original size and resize to a smaller percentage for a better result. Please use the embroidery software (PC) to resize very large and complex designs. It is available to purchase from your local authorized retailer. |
| <ul style="list-style-type: none">• Always start with the original design when resizing. This is to ensure the best possible stitch quality. If a resized design is saved, and then resized again, it can cause stitch irregularities. |
| <ul style="list-style-type: none">• It does not matter in which order you select functions to adjust the size, position and rotation. When you touch OK, your machine always resizes first and then adds the other adjustments. |
| <ul style="list-style-type: none">• It is recommended that you scale instead of resize to change a design less than 20%. Scale is also recommended for designs digitized with single or triple stitches, such as cross stitch embroideries. In this case, you do not want to add stitches to the design, you only want to make the design larger or smaller by making each original stitch larger or smaller. |

Embroidery Edit Pop-up Messages

Exceeded Maximum Number of Stitches

The design combination you are trying to make contains too many stitches. Your design combination can have a maximum of approximately 500,000 stitches.

Embroidery Combination is too Complex

This pop-up message appears for one of the following reasons:

- The design combination contains too many color blocks.
- There are too many designs in the combination.
- One or more designs have been grouped and re-grouped too many times.

9 Embroidery Stitch Out

Embroidery Stitch Out – Overview

To embroider your design(s), enter embroidery stitch out by touching the GO button in embroidery edit. Before entering embroidery stitch out you will see a Welcome to Embroidery Stitch Out window with your current embroidery settings.

Review your settings, make any necessary changes, then touch continue to enter embroidery stitch out. The embroidery unit needs to be connected in order to enter embroidery stitch out. Attach the correct hoop once you are in embroidery stitch out.

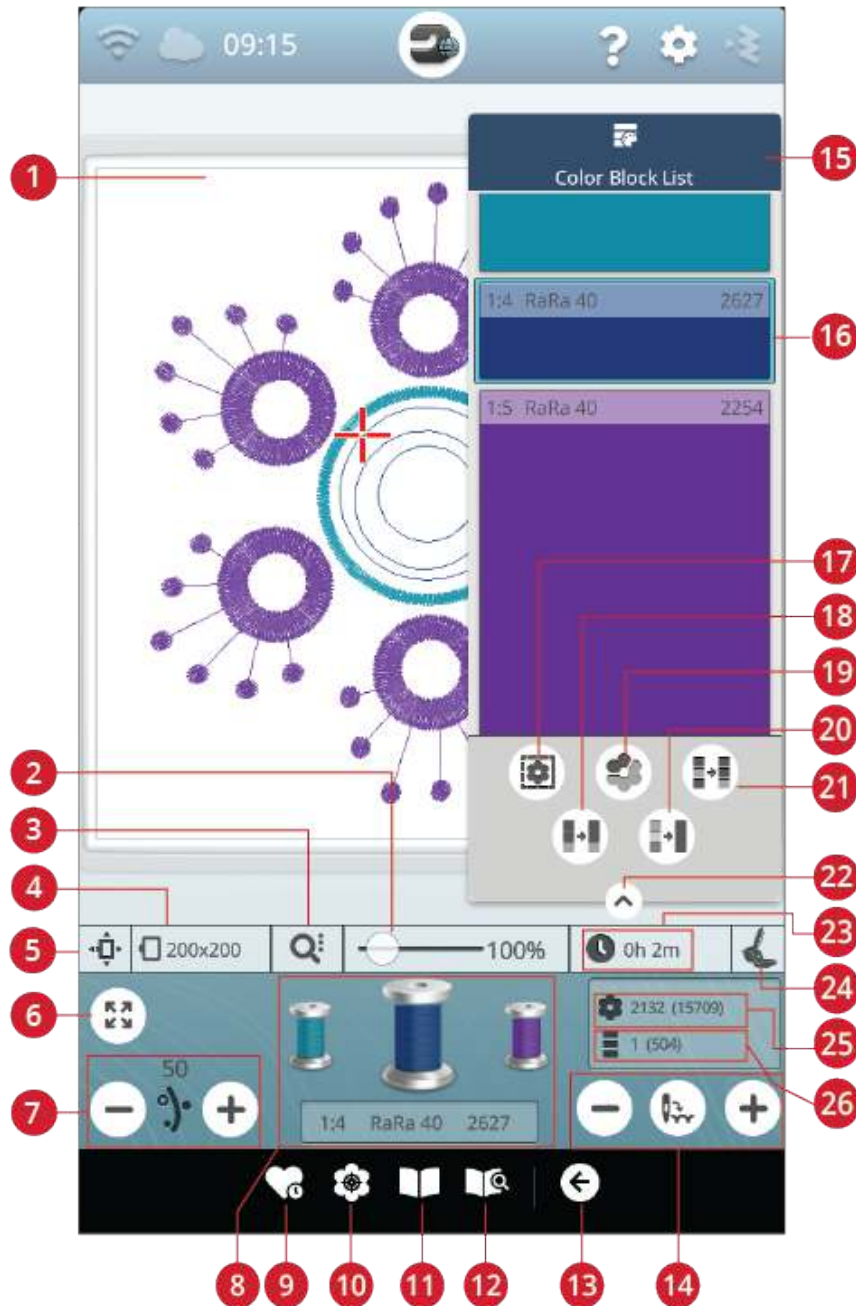

- | | | |
|-------------------------------------|--|--|
| 1. Embroidery area | 11. JoyOS ADVISOR™ project viewer | 21. Color block sort |
| 2. Zoom slider | 12. User's guide | 22. Minimize/expand color block list |
| 3. Zoom options | 13. Return to embroidery edit | 23. Remaining embroidery time by color block |
| 4. Selected hoop | 14. Step stitch-by-stitch/Go to stitch | 24. Selected embroidery foot type |
| 5. Hoop position options | 15. Color block list | 25. Total number of stitches in embroidery combination |
| 6. Corner check | 16. Color block | 26. Number of stitches in current color block |
| 7. Thread portioning/Thread tension | 17. Basting options | |
| 8. Thread color spools | 18. Color block merge | |
| 9. Smart save | 19. Highlight current color block | |
| 10. Design positioning | 20. Monochrome | |

Welcome to Embroidery Stitch Out

Before you enter embroidery stitch out mode, a “Welcome to Embroidery Stitch Out” window will appear. In this window you will see an overview of your current embroidery settings. Review your current embroidery settings to check that everything is set as you desire.

Touch continue to proceed to embroidery stitch out. Touch return to go back to embroidery edit.

Attached Needle Plate

The Straight Stitch Plate is generally recommended for best results in embroidery. Your DESIGNER SAPPHIRE™ 85 machine senses which needle plate is attached. If the needle plate shown is not the one you wish to use, attach your preferred needle plate. Read about how to change to the Straight Stitch Plate.

Selected Hoop

The currently selected hoop in embroidery edit is shown. If you want to change the hoop, touch return to go back to embroidery edit. There you can change the hoop in hoop selection. When you attach a hoop, the machine will sense which hoop is attached to confirm that the hoop attached is the selected hoop in embroidery edit.

Color Options

Preset your embroidery with any of the three color options: color block sort, color block merge or monochrome. You can also set these options in embroidery stitch out. Read more about color block sort, color block merge or monochrome.

Note: You can set both color block sort and color block merge if desired.

Basting Options

Select basting to add a basting stitch that will secure your fabric to your stabilizer. You can choose either baste around design or baste around hoop or both. Basting can also be activated in embroidery stitch out. Read more about basting options.

Selected Foot Type

Select which embroidery foot type you will use for the embroidery. The Sensor Q-Foot and deLuxe™ stitch system are recommended for best embroidery results. Whichever foot type you have selected in the temporary embroidery settings is the foot that will be shown in this window. You can change the foot type in the window and it will change the selected embroidery foot type in the temporary embroidery settings.

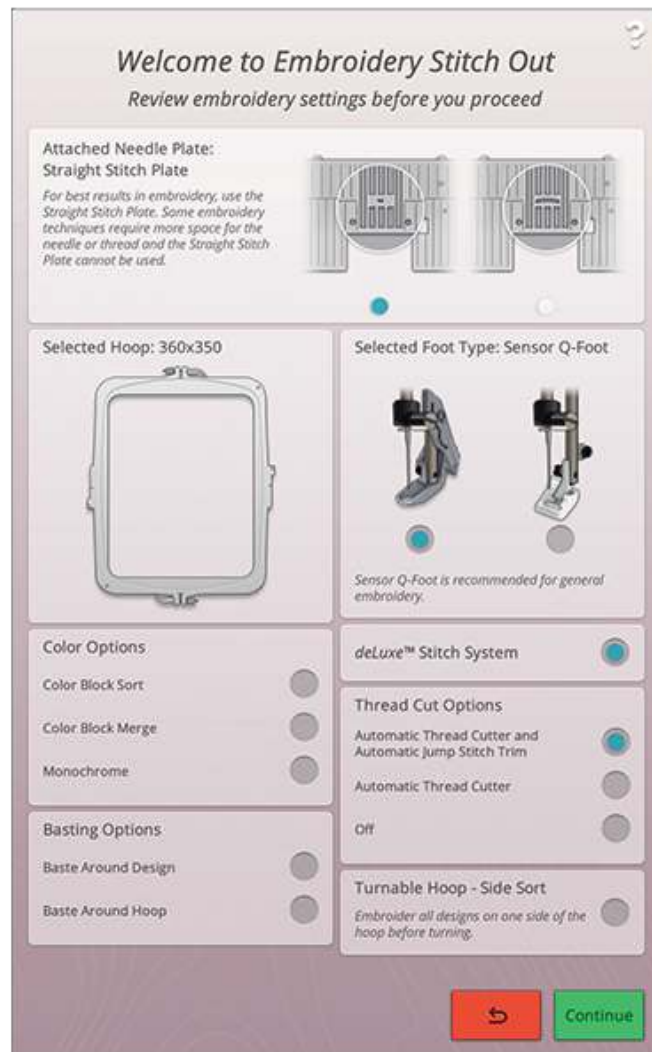

deLuxe™ Stitch System

Depending on which embroidery foot is selected in temporary embroidery settings the *deLuxe™* stitch system will be enabled/disabled. Embroidering with the *deLuxe™* stitch system and the Sensor Q-Foot is recommended for best embroidery results. Read more about the *deLuxe™* stitch system.

Thread Cut Options

Any settings for the thread cut options made in temporary embroidery settings will be shown in the window. You can also change the thread cut options in the window.

Turnable Hoop – Side Sort

This option will only be visible if the DESIGNER™ Majestic Hoop 360x350 is chosen in the hoop selection list in embroidery edit. If you want to embroider all designs on one side of the DESIGNER™ Majestic Hoop before you turn the hoop, select the side sort option before touching continue.

Color Block List

All colors in the loaded design(s) are shown in the order they will be embroidered. Each listed color shows the design number and color block order. Also shown are the thread manufacturer, thread weight and thread color number. The size of each color block gives an indication of how many stitches the color block contains.

Swipe down to scroll in the color block list to see all of the color blocks. The same information will be shown for the active color block in the thread color spools on the screen. To go to another color block, touch a color block in the color block list or swipe with your finger over the thread color spool to activate the next or previous color block in the color block list.

Example: 1:2 RaRa 40 2446, means the second thread color block in the first design to be embroidered is Robison-Anton Rayon 40 weight thread, number 2446.

If you want to minimize the color block list, touch the minimize/expand button or touch the color block menu button.

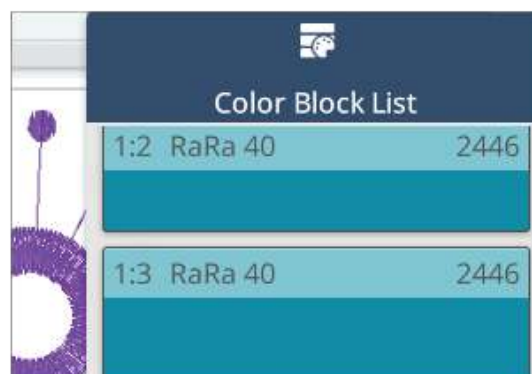

Zoom

Zoom in by touching with two fingers at the same time on the screen and, without releasing, increase the distance between the fingers to stretch. Zoom out by touching with two fingers at the same time on the screen and, without releasing, reduce the distance between the fingers to pinch.

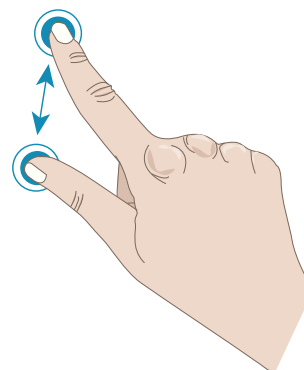

Alternatively use the zoom slider to zoom in and out in the embroidery area. Move the slider to the right to zoom in and to the left to zoom out. You will see how much you have zoomed to the right of the slider.

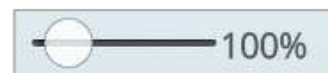

Zoom Options

Touch zoom options to choose between zoom to all or zoom to hoop. Zoom to all will show all the design(s) in the embroidery combination. Zoom to hoop will zoom to show the whole hoop on the screen.



1. Zoom to all
2. Zoom to hoop

Corner Check

Use corner check to trace the four corners of the design to see where the design will be stitched out on the fabric.

Each touch on the corner check button will move the hoop to the following positions and in the following order: upper left, upper right, lower right, lower left and then go back to the current stitch position.



Hoop Position Options

Use the hoop position options to move the embroidery arm to different positions.

Current Stitch Position

When you want to return to the current stitch position and continue embroidering after you have changed the hoop position, touch the current stitch position. You can also press the start/stop button once to return to the current stitch position and start the embroidery.

Park Position

Use the park position when you want to move the embroidery arm out of the way or when you want to pack the embroidery unit in the carrying bag.

Note: Normally the embroidery unit is in park position when in embroidery edit or sewing mode.

Trim Position

Trim position will move the hoop towards you, making it easier to trim threads and fabric for specialty techniques.

Tip: You can also use the needle up/down button on your machine as a shortcut to move the hoop to trim position.

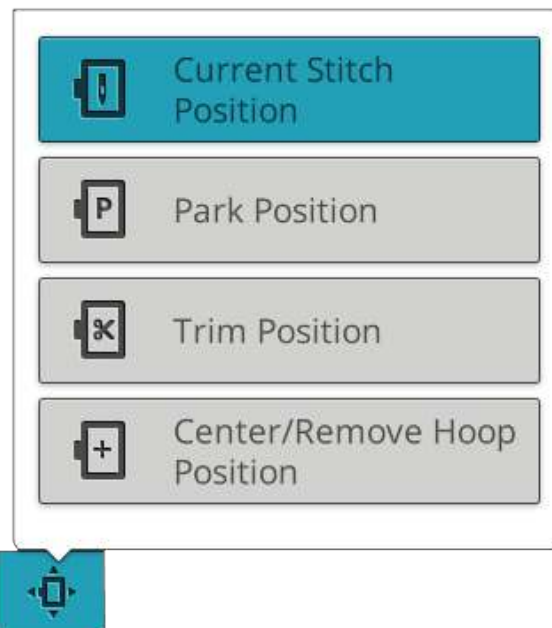

Center/Remove Hoop Position

When you need to remove the hoop, e.g. when changing a bobbin, touch the center/remove hoop position. This will also show the center position of the hoop.

Tip: You can also use the stitch re-start button on your machine as a shortcut to move the hoop to center/remove hoop position.

Design Positioning

Use the design positioning feature to place a design on an exact location on your fabric without re-hooping. It can also be useful when you want to embroider a design to exactly match a specific spot on your project or next to a previously embroidered design.

Tip: Use your JoyOS ADVISOR™ feature to locate instructions for design positioning on how to use the design positioning feature.

Touch the design positioning button to open the design positioning window.

To move your design in the hoop without selecting a specific locking point, touch and move your design until you are satisfied with the placement. You can also open set cursor point options and touch the set cursor point center button to quickly find the center of your design and move the design to the center of your hoop if needed.

To position the design with a locking point on your design that matches a specific position on the fabric or previously stitched design, go through steps 1 and 2 in the design positioning wizard.

To position and rotate the design with a locking point and matching point to match a specific position on the fabric or previously stitched design, go through steps 1-4 in the design positioning wizard.

Touch OK when satisfied with your design placement or touch cancel to close the design positioning feature without saving any changes.

Tip: If you just want to move your embroidery in the hoop, open design positioning and move your design with your finger on the screen or use the control wheel.

Zoom the embroidery area to be sure that you are placing the design exactly where you want it by touching the zoom options and using the zoom to cursor button. You can also use the pinch/stretch function or use the zoom slider to zoom in and out. You will see how much you have zoomed to the right of the slider.

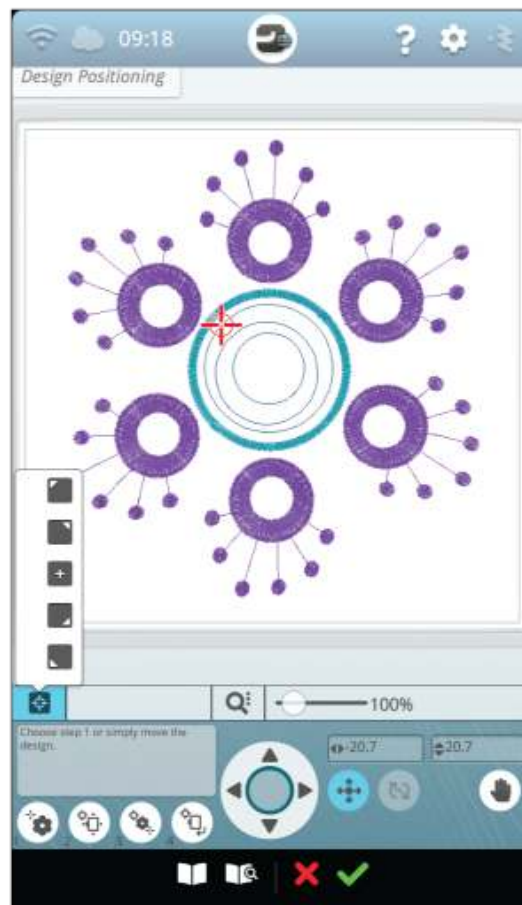

Design Positioning Wizard

1. To Select a Locking Point on Screen

Touch number 1 to select a locking point. Move the blue cursor with your finger to the point in the design on your screen that you want to match to a point on your fabric/ previously stitched design. Fine tune with the arrows in the control wheel. If you want to place the locking point in a corner or center of the design, open set cursor point options and use set cursor point buttons. Touch the zoom options button and use the zoom to cursor to maximize the zoom and pan the embroidery area for exact position of the cursor.



2. Move Locked Point on Fabric

Touch number 2. The blue cursor will be locked to the design. It will change color from blue to red with a ring around the center of the locking point. Touch and move with your finger on the screen to position your design exactly where you want it to match on the fabric or to the previously stitched design. Use the arrows in the control wheel to fine tune. Watch the hoop until the needle is exactly where you want it to be on the fabric or the previously stitched design. The locking point on the fabric shows the position of the needle in the design.



Note: If satisfied with the placement of your design, touch OK to close design positioning. If you also need to adjust the angle of the design, continue with step 3.

3. Set Matching Point on Screen

Touch number 3 to select another matching point on the design to match a second position on the fabric or previously stitched design.

Touch and move the blue cursor on the screen to where you would like the matching point to be in your design. Fine tune with the arrows in the control wheel. Use the zoom to cursor button to maximize the zoom and pan the embroidery area for exact position of the cursor.



4. Rotate Design on Fabric

Touch number 4. The touch function rotate is automatically selected. Touch and move using your finger on the screen, or use the arrows in the control wheel, to rotate the design until the needle is exactly where you want it to be on the fabric or the previously stitched design. Touch OK to close design positioning.

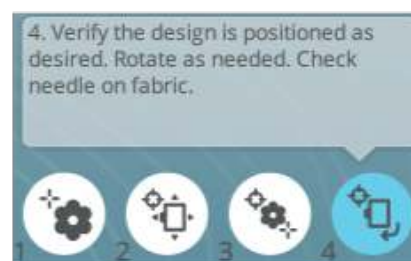

Zoom to Cursor

Touch the zoom options button to find zoom to cursor. When using the zoom to cursor it will maximize the zoom and pan the embroidery area so the cursor position is centered on the screen.

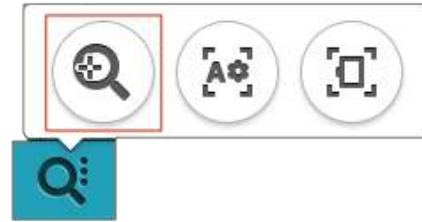

Set Cursor Point

Open set cursor point options. Move the cursor point to any of the selected corners or to the center of the design. The set cursor point can be used to trace the design field by touching each of the four corner buttons. Find the center of the design by touching the set cursor point center button.



deLuxe™ Stitch System

The control visible in embroidery stitch out will change depending on whether the deLuxe™ stitch system is active or not in the temporary embroidery settings. Use the controls to adjust the balance between upper thread and bobbin thread, e.g. when embroidering with specialty thread. Read more about the deLuxe™ stitch system in temporary embroidery settings.



Thread portioning



Thread tension

Smart Save

If you want to save your work, including loaded stitch, loaded embroidery, current stitch position and settings, touch the smart save button. A pop-up will indicate that a smart save has been done and you can now turn off the machine or start a new JoyOS ADVISOR™ project. Smart save remembers and stores all your design and stitch adjustments along with your settings. This makes it possible to continue your work later.

To load the last performed smart save, touch the load smart save button in the *JoyOS advisor™* feature.

Note: When you touch smart save the previously saved smart save will be deleted.



Home screen button



Load smart save button

Auto Smart Save

When embroidering your DESIGNER SAPPHIRE™ 85 machine will continuously and automatically save your ongoing work, including the loaded stitch, embroidery, current stitch position and settings. If there is a power outage when you are in embroidery stitch out a pop-up will appear when your machine is restarted. In the pop-up you can choose to return to embroidery stitch out and bring up the design ready to stitch. The embroidery will start from approximately the same position as it was interrupted from.

Tip: Before starting the embroidery go back a few stitches using the step stitch-by-stitch control to ensure that the threads will be secured.

Thread Color Spools

All colors in the loaded design(s) are shown in the order they will be embroidered in thread color spools. Underneath the current thread color spool, information about the design number and color order is shown. Also shown are the thread manufacturer, thread weight and color number. Swipe left or right on the thread color spools to activate the next or previous color block in the color block list.

While embroidering, the shade of the active thread color spool will fade indicating how much of the color block is left to embroider.

Example: 1:2 RaRa 40 2254, means the second thread color in the first design to be embroidered is Robison-Anton Rayon 40 weight thread, number 2254.



Return to Embroidery Edit

Touch the return button to return to embroidery edit where you can adjust your design(s).



Step Stitch-by-Stitch/Go to Stitch

Touch + to step forward and - to step backwards stitch by stitch. Move backwards a few stitches, e.g. after the upper thread breaks or runs out, to ensure that the thread will be secured. Touch & hold to move through the stitches more rapidly. The cursor on the screen will follow the stitches in the embroidery area.

To go to a particular stitch within the color block, touch the go to stitch button and enter the stitch number. If the number entered is too large, the machine will move to the last stitch in the current color block.



Number of Stitches in Current Color Block

The current stitch position in the current color block is shown next to the color block icon. The number in brackets shows the total number of stitches in the current color block.



Number of Stitches in Embroidery Combination

The current stitch position in embroidery combination is shown next to the flower icon. The numbers in brackets shows the total number of stitches in the design or combination.



Remaining Embroidery Time by Color Block

An estimation of the remaining embroidery time for the current color block is shown in hours and minutes next to the clock icon. If monochrome is activated, the estimated remaining embroidery time for the whole embroidery combination is shown.

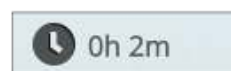

Color Options

Use the color options to stitch your design easier and faster.

Color Block Sort

Color block sort intelligently sorts all color blocks so that the blocks with the same color will follow each other in the color block list.

Note: Color block sort has to be performed before you start to embroider. Once you have started to embroider the color block sort button will be greyed out.

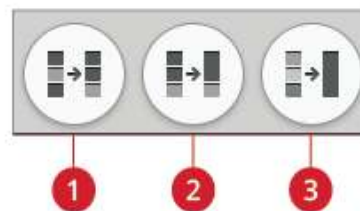

1. Color block sort button
2. Color block merge button
3. Monochrome button

Color Block Merge

Activate color block merge to eliminate the stops between identical color blocks.

Note: The appearance of the color block list will remain the same.

Monochrome

Touch the button to activate monochrome embroidery. All designs are shown in a grey color and the machine will not stop for color block changes. To deactivate monochrome embroidery, touch the button again.

Note: If the automatic thread cutter and automatic jump stitch trim function is selected in temporary embroidery settings the jump stitches will still be trimmed between the color blocks.

Tip: You can also touch the STOP function on your machine as a shortcut to activate monochrome.

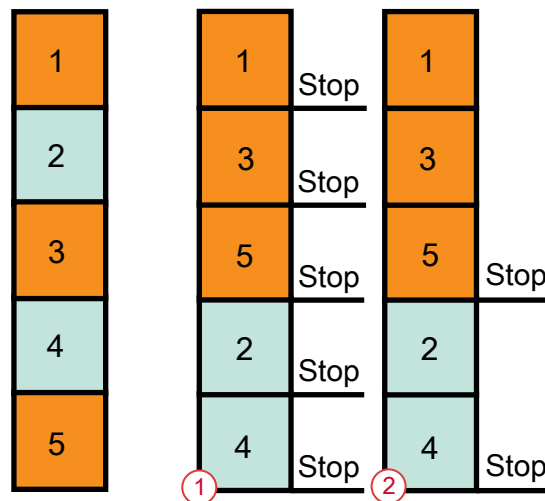

1. Color block sort
2. Color block sort and color block merge

Highlight Current Color Block

Touch the button and only the color block that is currently stitching will be visible in the embroidery area. All other color blocks will be greyed out.



Highlight current color block can be useful when your design contains color blocks in different shades of the same color, especially if they are close to or overlapping each other.

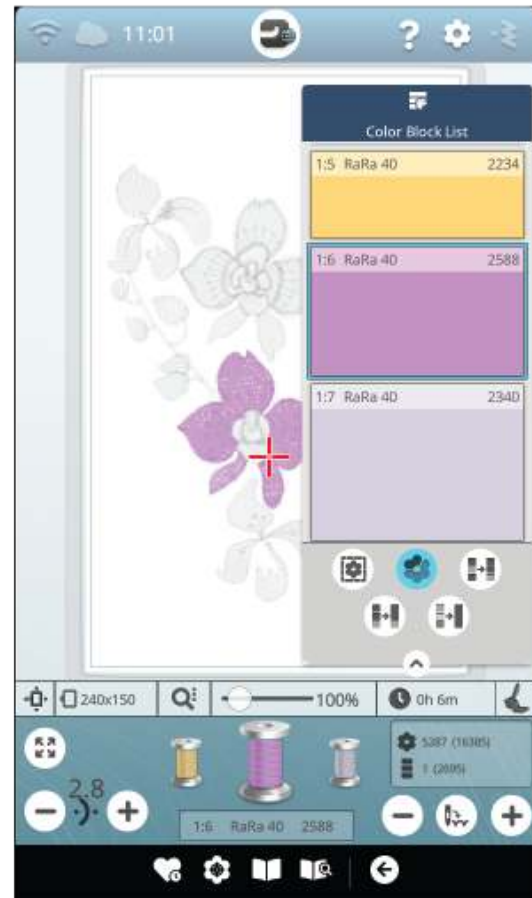

Basting Options

Basting enables you to secure your fabric to a hooped stabilizer. It is especially useful when the fabric that is going to be embroidered cannot be hooped. Basting provides support for stretchy fabrics.

Touch the basting options button. The basting options can also be set in the “welcome to embroidery stitch out” window before entering embroidery stitch out.

Touch baste around design to add a basting stitch around the design, outlining the area where the design will be placed on the fabric.

Touch baste around hoop area to add a basting stitch around the inside edge of the hoop.

You can select both basting options to add additional support for certain fabrics and techniques.

Note: When activated only the basting color blocks will be shown in the color block list. When basting is complete the color block list will once again show the color blocks of your design.

Tip: Touch the FIX function on your machine to activate baste around design.



Basting options button

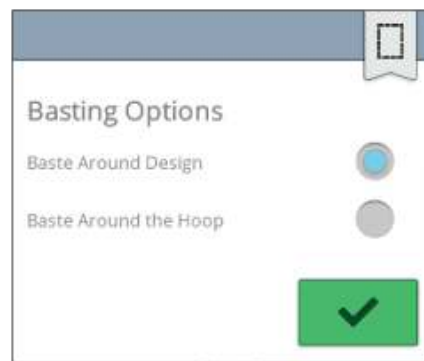

Basting options pop-up

Embroidery Stitch Out Pop-up Messages

The Embroidery Arm Needs to Calibrate

When the embroidery unit is attached, a pop-up message will appear and inform you to slide off the hoop and clear the machine area for calibrating the embroidery arm. You will also be reminded to attach a suitable embroidery foot.



It is very important to remove the hoop, otherwise the hoop or the embroidery unit may be damaged while calibrating.

Attach Hoop

If the hoop attached to the machine does not match the hoop that is selected and displayed on the screen, the machine will not embroider. You must change the hoop to the one displayed on the screen or return to embroidery edit and select the hoop to match the attached hoop.

The hoop needs to be inserted properly for the machine to detect it. Slide the hoop connector into the hoop attachment from front to back until it clicks into place.

Bobbin Thread Low

When the bobbin thread is running low, a pop-up message appears giving you advance notice that you will soon need to change the bobbin. This gives you an opportunity to plan when you want to change your bobbin.

It is possible to embroider until the thread has completely run out. Without closing the pop-up, touch the start/stop button, or the foot control, to continue embroidering.

Touch cancel to remain at the current stitch position.

Touch OK to move the hoop to the center/remove hoop position. The hoop position pop-up opens. Replace the empty bobbin with a full one. Touch current position in the pop-up and pull back any excess length of needle thread. Touch the start/stop button to continue embroidering.

Check Upper Thread

The machine stops automatically if the upper thread runs out or breaks. Re-thread the upper thread from the beginning, close the pop-up message and then go back a few stitches using the step stitch-by-stitch control to ensure that the thread will be secured. Re-start your embroidery.

Change Thread

When it is time to change the upper thread, the machine will stop. Change the spool of thread and re-thread the machine. The recommended thread color number is shown in the pop-up message.

Cut and Remove the Thread Tail

After changing the thread, the machine will sew a few stitches and then stop so you can cut the thread tail.

Note: When automatic thread cutter and automatic jump stitch trim function is selected in temporary embroidery settings, the thread will be cut automatically and no cut thread tail pop-up will be shown. Simply remove the thread tail that has been cut.

Your Embroidery is Finished

A pop-up message and sound informs you that your embroidery is finished. When the pop-up is closed the design will stay loaded in embroidery stitch out and you can stitch the same embroidery again, including any changes you have made.

Auto Smart Save

If a power outage has occurred, you will see this pop-up message when the machine is restarted. Touch OK in the pop-up to return to embroidery stitch out. This will load the design ready to stitch from approximately the same position it was interrupted.

Tip: Before starting the embroidery go back a few stitches using the step stitch-by-stitch control to ensure that the threads will be secured.

Change Needle (Optional Accessory)

Cutwork designs and felting designs require special optional needle accessories. Cutwork designs require the HUSQVARNA® VIKING® Embroidery Cutwork Needle Kit (920268-096) and felting designs require the HUSQVARNA® VIKING® Felting Embroidery Set (920402-096).

When the machine stops and this pop-up message is shown, insert the corresponding optional needle. Touch OK and press the start/stop button to resume.

Cutwork designs are marked with a cutwork needle symbol and felting designs are marked with a felting needle symbol in the DESIGNER SAPPHIRE™ 85 Sampler book.

Note: Cutwork designs can also be stitched out without using the cutwork needles. The cutwork area will then have to be cut manually and the color block for the cutwork needle in the color block list should be skipped.

Attention!

If the machine stops and this pop-up appears on the screen you cannot continue embroidering. Wait a moment and touch OK when it is enabled. Check needle size and condition and check that your machine is threaded correctly.

10 Program



Program – Overview

You can combine stitches and/or letters and numbers to create stitch programs. Combine various decorative stitches and stitch fonts from the from the machine stitch menus, *mySewnet*™ cloud folder on the machine, or from a USB device.

You can program stitches up to approximately 500 mm (20") long. You can see how long your stitch program is at the top of the window. You can program in both sewing and in embroidery edit.

Tip: If sewing mode is active and your stitch program is ready to be sewn, you can close the program window by pressing the foot control, or by pressing the start/stop button.

Note: Not all stitches are available to program. A pop-up message will alert you if you try to select an unavailable stitch.

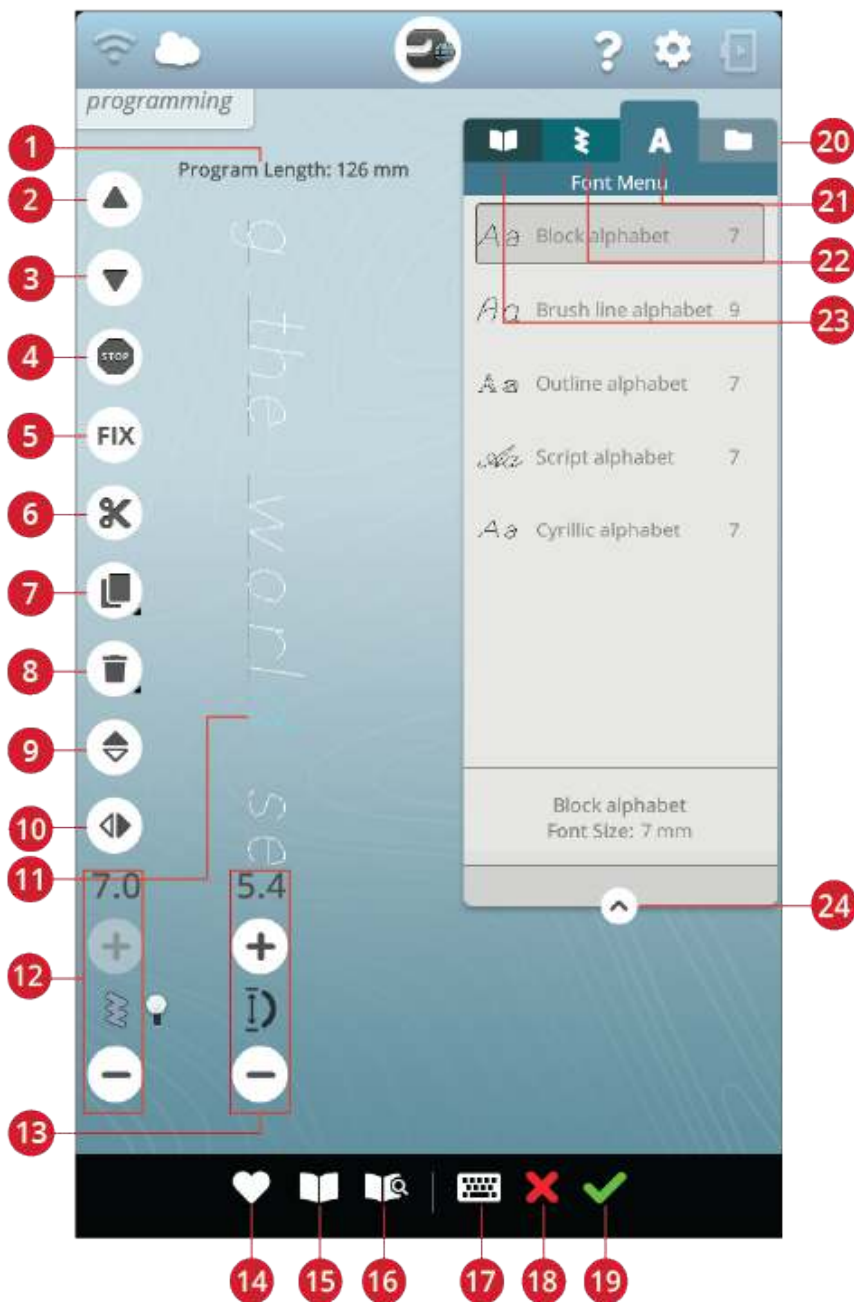

1. Program length
2. Step to previous stitch/go to last
3. Step to next stitch/go to first
4. STOP command
5. FIX command
6. Thread cut command
7. Duplicate

8. Delete
9. Mirror end to end
10. Mirror side to side
11. Cursor
12. Stitch width/Stitch positioning
13. Stitch length/Stitch density
14. Save

15. JoyOS ADVISOR™ project viewer
16. User's guide
17. Open keyboard
18. Cancel program

19. OK, return to sewing mode/embroidery edit
20. File manager
21. Font menu

22. Stitch menu
23. JoyOS ADVISOR™ project menu
24. Minimize/expand selection area

Create New Program

1. To create a new program, touch the program button to open the program window.

2. Touch the stitch menu or font menu to select the stitch or a font you want to use.

3. Insert stitches from file manager or the stitch menu. The active position is shown with a cursor and the stitch or letter is highlighted. Inserted stitches or letters will be selected and placed at the cursor. Only the selected stitch or letter can be adjusted. You can move the cursor through the stitch program by using the step to previous stitch/step to next stitch arrows.

Note: A straight line at the point of the arrows indicates go to last/go to first stitch.



Stitch menu

Font menu



Active position is highlighted



Step to previous stitch/step to next stitch

4. When the font menu is selected the keyboard is opened automatically to write your text. Minimize the keyboard by touching the top right corner to be able to access the OK button.



5. Touch the OK button to load your program to sewing mode. Alternatively load your program by pressing down the foot control or touch the start/stop button on your machine. Touch cancel to undo your program and close the program window.



To Edit a Created Program

If you want to edit an already loaded program in sewing mode, touch the edit stitch program button and you will enter the program window again. Alternatively, touch & hold on the program to open the smart toolbox to access the edit button. Make your adjustments and touch OK in the program window to load it to sewing mode with your adjustments. Touch the cancel button in program to undo.



Edit Stitch or Lettering Program

Insert a Stitch or Letter

Move the cursor to the point where you want to add a stitch or letter by using the step to previous/step to next stitch button. If the step to previous arrow has an underline you will move the cursor to the end. If the step to next arrow has an underline you will move the cursor to the beginning. Touch the desired stitch in the stitch menu or in file manager to add it at the cursor position.

Touch the font menu and touch a letter to insert it at the cursor. Change to a different font style by touching another font style in the selection area. Close the keyboard at the top right corner. If you touch the stitch menu or file manager the keyboard will close automatically. You can open the keyboard again by touching the keyboard button or touching the font menu.



Keyboard button

Adjust a Stitch or Letter

You can mirror, adjust the length, width and position or change the density of the selected stitch, in the same way you can adjust the stitch settings in sewing mode.

Touch & hold over the program on the screen to open the smart toolbox. The smart toolbox will allow you to duplicate, delete or mirror the selected stitch or letter in the program.



Delete a Stitch or Letter

If you want to delete a stitch, move the cursor to the stitch or letter you want to delete (the selected stitch or letter will be blue) and touch the delete button on the screen or in the smart toolbox. Touch & hold the delete button to delete the entire program.

Duplicate a Stitch or Letter

To duplicate a stitch, move the cursor to the stitch or letter you want to duplicate (the selected stitch or letter will be blue) and touch the duplicate button on the screen or in the smart toolbox.

Note: Make your adjustments to the stitch before duplicating and the duplicated stitch will include the adjustments.

Touch & hold to use the keypad where you can enter the exact number of copies you want to insert.

1. Step to previous stitch/go to last
2. Step to next stitch/go to first
3. Cursor
4. Duplicate
5. Delete
6. Mirror end to end
7. Mirror side to side

Replace a Stitch or Letter

To replace a stitch or letter, simply select it using the scroll arrows to select the stitch or letter you wish to replace and touch delete. Insert the new stitch or letter and it will be placed at the cursor.

Adjust the Entire Program

To adjust the entire program, return to sewing mode by touching the OK button. Adjustments made here will affect the entire program. Read about the different stitch settings in sewing mode that will adjust your entire program.



Stitch Program Commands

You can insert FIX, STOP and thread cut commands into the stitch program. These commands will be included in the stitch program and will always be performed when sewing it.

Move the cursor to the position where you want to add a command. Touch the command and an icon will be added into the programmed stitch. This confirms that the command is inserted and it also shows where the command will be performed in the stitch program.

Note: If creating a stitch program in embroidery mode, tie-offs will be added automatically at the beginning and end, allowing you to create a stitch program in between. The commands can be removed.



Insert a STOP command by touching the STOP button on the screen. The STOP command will make your machine stop at the selected position in your programmed stitch. This is useful, e.g. if you want to create a stitch program with several rows.



Insert a FIX command by touching the FIX button on the screen. The FIX command will insert a tie-off at the selected position in the program. You can insert the FIX command anywhere in the program.

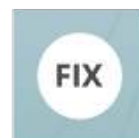

Insert a thread cut command by touching the thread cut button on the screen. Add a thread cut command if you want the machine to tie-off and cut the threads.



Note: If automatic thread cutter is deselected in temporary settings the machine will only fix and stop when it reaches a thread cut command.

Save Program

To save your file, touch the save button and a pop-up will appear on the screen. In the save pop-up you can choose to save the file to the *mySewnet*[™] cloud folder or to a USB device. Previously saved designs, stitches, programs and/or fonts are shown. Name your file with the keyboard and touch the OK button.

If you want to save to a folder, simply touch & hold on the folder to open it, then name your file with the keyboard and touch OK in the pop-up to save. To create a new folder, simply touch the create new folder button, name the folder with the keyboard and touch OK. Then touch & hold on the folder to open it and save into the new folder.

Touch the list and thumbnail view button to toggle between showing the files in a list or as thumbnail icons. In list view each file is shown with the file name and file type. In thumbnail view each file is shown with file name and a thumbnail image of the file.

To cancel the save process, close the pop-up window by touching cancel. The save pop-up and you will return to program mode.

Learn how to organize your saved files in file manager.



Save button in embroidery edit

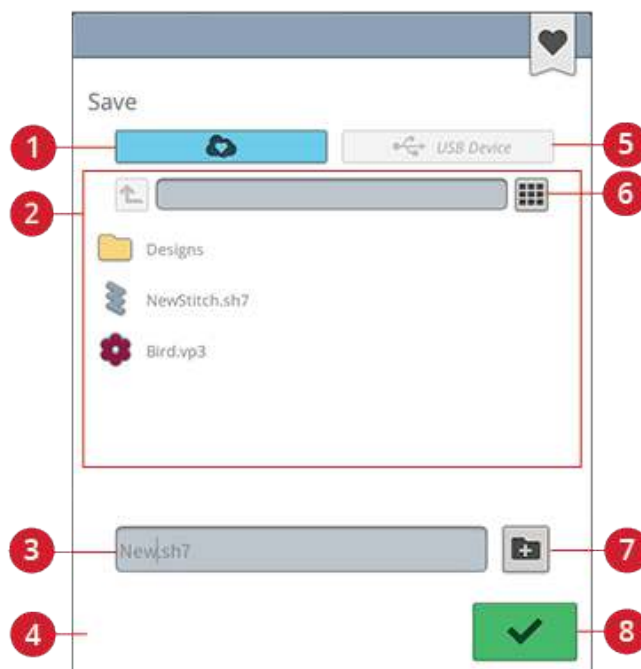

1. Save to the *mySewnet*[™] cloud folder
2. Selection area
3. File name
4. Cancel
5. Save to a USB device folder
6. Toggle between list and thumbnail view
7. Create new folder
8. Confirm

Sew or Embroider Your Stitch Program

To sew your stitch program, load it to sewing mode by touching the OK button in the program window.

If you have opened program in embroidery edit, touching OK in the program window will load your program to embroidery edit.

Note: A program created in embroidery mode will be loaded and saved as a design and can not be sewn as a stitch in sewing mode.



Program Pop-Up Messages

Not a Programmable Stitch

Some stitches are not possible to insert in a stitch program, for example buttonholes and special stitch menus such as theme stitches.

The Maximum Number of Stitches Has Been Reached

The stitch you are trying to add will make the stitch program too long. Your stitch program can be up to approximately 500 mm (20") long and contain up to 199 stitches and commands. If the stitch program exceeds the maximum length this pop-up message will appear.

II Settings

Temporary Sewing Settings

Change your temporary sewing settings when you want to change a sewing related setting for your current project. Changes made to temporary sewing settings will be reset at the start of a new JoyOS ADVISOR™ project from the JoyOS ADVISOR™ feature. When turning the machine off, all changes made in temporary sewing settings will be reset to default.

The following settings can be set in temporary sewing settings:

- *deLuxe*™ stitch system
- Presser foot lift
- Automatic thread cutter
- Automatic FIX
- Stitch limiting options
- Feed teeth options

deLuxe™ Stitch System

When the *deLuxe*™ stitch system is selected your machine will automatically choose the best way to control the upper thread, thread portioning or thread tension, based on your selected stitch and settings. Thread portioning automatically and continuously measures the fabric thickness to portion the correct amount of thread for the selected stitch. When using thread tension, the tension discs will keep the correct amount of tension on the upper thread.

For best sewing results we strongly recommend you to keep this setting selected except when using specific special techniques or accessories that do not support thread portioning. Deselect the *deLuxe*™ stitch system in the temporary sewing settings to switch to thread tension.

The control for adjusting thread portioning/thread tension, visible in sewing mode, will change depending on the active stitch and whether the *deLuxe*™ stitch system is selected or not in temporary sewing settings.

Sensor Presser Foot Lift

When selected, the machine automatically raises the presser foot in the following situations:

- When stopping with the needle in the down position the presser foot will automatically raise to pivot height.
- After a cut the presser foot will be raised to lift position.

When deselected, the presser foot will stay lowered.

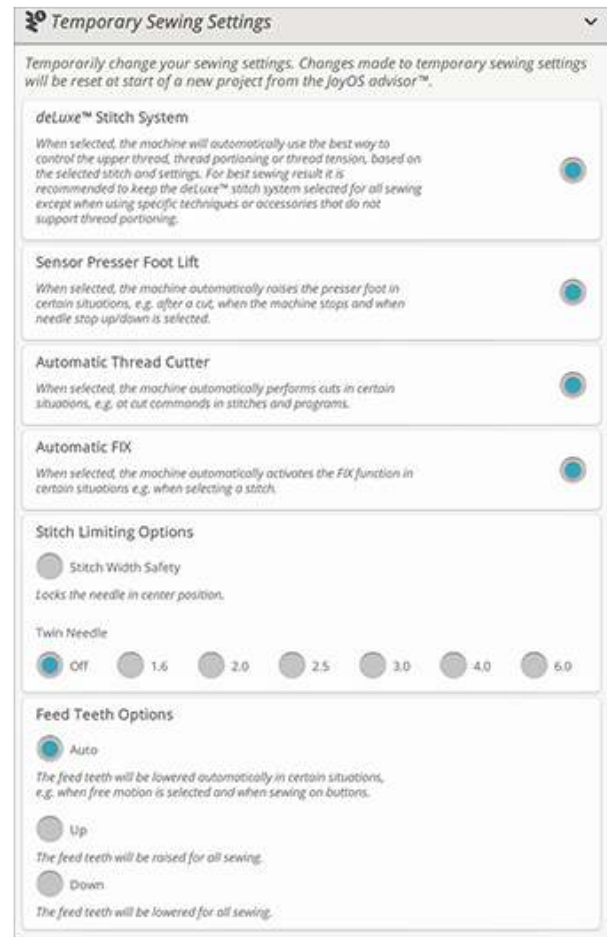

Automatic Thread Cutter

When selected, the threads are cut automatically in the following situations:

- At cut commands in stitches and programs.
- After sewing a single stitch or a monogram or eyelets.

If deselected, no automatic thread cut will be performed.

Note: Deselect when using optional accessories that are attached in the two holes in the needle plate just above the bobbin cover, to prevent damage to the automatic thread cutter knife located under the needle plate.

Automatic FIX

When selected, the machine will automatically activate the FIX function after a cut has been performed and when a stitch is selected.

Stitch Limiting Options

Set the machine to either stitch width safety or select the size of the twin needle to limit the stitch width and stitch positioning. This will minimize the risk of breaking a needle when sewing with accessories that do not allow the use of the entire stitch width.

Stitch Width Safety

When selected, the machine will only allow a centered straight stitch to prevent damage to the needle, presser foot and needle plate. Select stitch width safety when using an accessory that only supports a centered needle position e.g. straight stitch presser foot. Stitch width safety will automatically be selected when the Straight Stitch Plate is attached to the machine and cannot be deselected as long as the Straight Stitch Plate is attached.

When the Straight Stitch Plate is removed you will be given the option to keep stitch width safety selected or to deselect it. When stitch width safety is activated all twin needle sizes will be disabled as they cannot be used together with stitch width safety.

Note: The settings are reset at the start of a new project from the JoyOS ADVISOR™ feature. Always make sure to remove any accessory that requires this setting or select the setting again after starting a new project.

Twin Needle

When a twin needle size is selected, the stitch width and stitch position of all stitches are limited according to the selected twin needle size to prevent damage to the needle, presser foot and needle plate. In sewing mode the stitch preview will indicate that a twin needle is selected. When a twin needle size is selected, the stitch width safety will be disabled as it cannot be used together with a twin needle.

Note: The settings are reset at the start of a new project from the JoyOS ADVISOR™ feature. Always make sure to remove any accessory that requires this setting or select the setting again after starting a new project.

Feed Teeth Options

When auto is selected (recommended) your machine automatically raises or lowers the feed teeth, depending on the stitch and other selected settings. For example, the feed teeth are lowered when sewing on buttons or when free motion sewing.

Select up and the feed teeth will be raised for all sewing.
Select down and the feed teeth will be lowered for all sewing.

Note: Regardless of which option is selected the machine will always lower the feed teeth automatically when raising the presser foot to extra lift position.

Note: The feed teeth options will automatically be reset to auto at the start of a new project from the JoyOS ADVISOR™ feature.

Temporary Embroidery Settings

Change your temporary embroidery settings when you would like to change an embroidery related setting for your current project. Changes made to the temporary embroidery settings will be reset at the start of a new project from the JoyOS ADVISOR™ feature. When turning the machine off, all changes made in temporary embroidery settings will be reset to default.

The following settings can be set in temporary embroidery settings:

- *deLuxe*™ stitch system
- Embroidery foot type
- Thread cut options
- Twin needle options

deLuxe™ Stitch System

When the *deLuxe*™ stitch system is selected your DESIGNER SAPPHIRE™ 85 will automatically choose the best way to control the embroidery upper thread based on the design and the selected settings: thread portioning or thread tension. For best embroidery results we strongly recommend that you keep this setting selected and select the Sensor Q-Foot for embroidery foot type.

When the *deLuxe*™ stitch system is selected thread portioning will be used when the embroidery foot type, Sensor Q-Foot, is selected unless, e.g. the active color block indicates a felting color block or a cutwork needle color block in the color block list.

When the *deLuxe*™ stitch system is deselected and/or embroidery foot type is set for floating foot, thread tension will be used for all designs and settings.

For some specific special techniques and accessories that cannot be embroidered with thread portioning, the *deLuxe*™ Stitch System needs to be deselected.

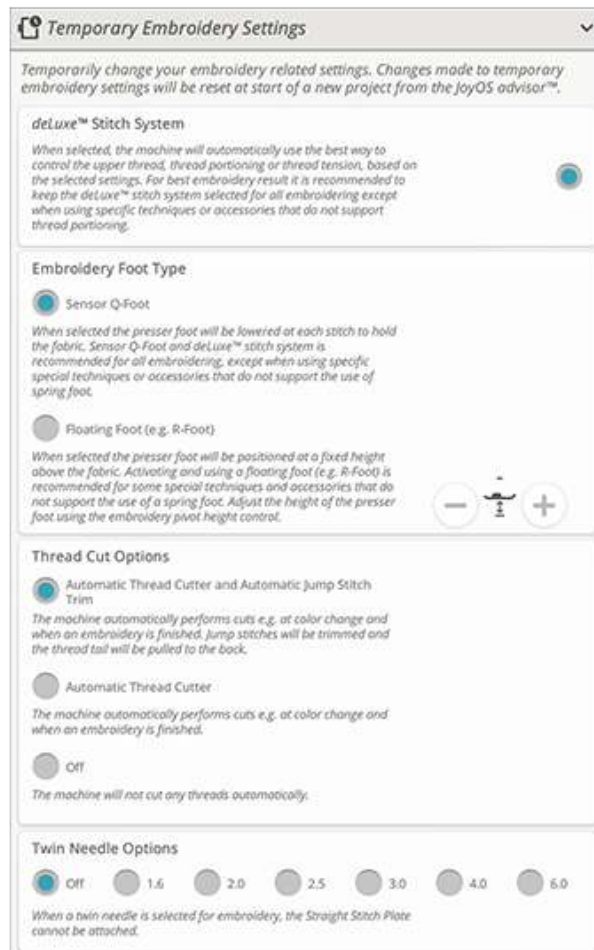

Embroidery Foot Type

Select either the Sensor Q-Foot or floating foot. It is very important that the correct setting is selected for the attached embroidery foot.

For best embroidery results, select and use the Sensor Q-Foot and the *deLuxe*[™] stitch system. This is strongly recommended. Some specific specialty techniques and/or accessories do not support the use of the Sensor Q-Foot, e.g. yarn couching and felting.

When the Sensor Q-Foot is selected the machine will lower the foot to hold the fabric at each stitch. When the floating foot is selected the machine will lower the foot to a pivot height above the fabric. When using a floating foot the presser foot height can be adjusted for improved performance when using different weights of material and/or embroidery threads.

Note: The embroidery foot type will automatically be reset to Sensor Q-Foot at the start of a new project from the JoyOS ADVISOR[™] feature. Make sure you attach the Sensor Q-Foot or change the setting to floating foot (e.g. R-Foot).

Thread Cut Options

Choose between three thread cut options: no thread cuts, automatic thread cut and a combination of automatic thread cut and automatic jump stitch trim.

Off

When selected, no automatic thread cuts will be performed by the machine.

Automatic Thread Cutter

When selected, thread cuts will be automatically performed in the following situations:

- Upper thread is cut automatically and the presser foot raises at color changes.
- Bobbin thread and needle thread are cut and the presser foot raises when an embroidery is finished.

Automatic Jump Stitch Trim

When selected, cuts will be automatically performed and needle thread pulled to the underside of the fabric. This function saves you time trimming after the embroidery is completed. The upper thread will be cut and pulled to the underside of the fabric when starting to embroider after a color change, at the first color block, after stepping stitches and when the machine continues to embroider after a jump stitch.

Thread cuts will be automatically performed in e.g. the following situations:

- Upper thread is cut automatically and the presser foot raises at color changes.
- Bobbin thread and upper thread are cut and the presser foot raises when an embroidery is finished.
- Upper thread is cut automatically at the start of a jump stitch.
- Cut commands in designs, stitches or programs.



Designs marked with this symbol are programmed for automatic jump stitch trim. Jump stitch trim commands can be added to any design using the complimentary software.

Tip: Hold the thread tail when you start embroidering or at a new color block so that you can easily remove the thread end when cut.

Tip: If the front and back of your embroidery will be visible, turn off the automatic jump stitch trim and cut the threads manually.

Tip: If your designs are very close together, e.g. lettering or programmed stitches, turn off the automatic jump stitch trim and cut the thread manually.

Twin Needle Options

When a twin needle size is selected the *deLuxe™* Stitch System will automatically use thread tension. When embroidering with a twin needle the Straight Stitch Plate needs to be removed as it cannot be used together with a twin needle. The twin needle setting will automatically be set when loading a twin needle embroidery project from the JoyOS ADVISOR™ project menu.

Note: It is very important to activate the twin needle setting when embroidering with a twin needle to prevent damage to the machine.

Default Sewing Settings

Settings made in the default sewing settings will be saved, even when turning your machine off.

deLuxe™ Stitch System – Default

When selected the *deLuxe™* stitch system will automatically be selected in the temporary sewing settings for all new projects loaded from the JoyOS ADVISOR™ feature. For more information see the description in the temporary sewing settings.

Sensor Presser Foot Lift – Default

When selected the sensor presser foot lift will automatically be selected in the temporary sewing settings for all new projects loaded from the JoyOS ADVISOR™ feature. For more information see the description in the temporary sewing settings.

Automatic Thread Cutter – Default

When selected the automatic thread cutter will automatically be selected in the temporary sewing settings for all new projects loaded from the JoyOS ADVISOR™ feature. For more information see the description in the temporary sewing settings.

Automatic FIX – Default

When selected the automatic FIX will automatically be selected in the temporary sewing settings for all new projects loaded from the JoyOS ADVISOR™ feature. For more information see the description in the temporary sewing settings.

Free Motion Options – Default

Choose between three free motion options: free motion floating, free motion ruler foot or free motion spring action. When one of the free motion options is selected the corresponding free motion mode will automatically be selected in sewing mode for all new projects loaded from the JoyOS ADVISOR™ feature.

It is recommended that you do not set an option for free motion in the default sewing settings; choose an option in sewing mode instead.

For more information see the description in the free motion options in sewing mode

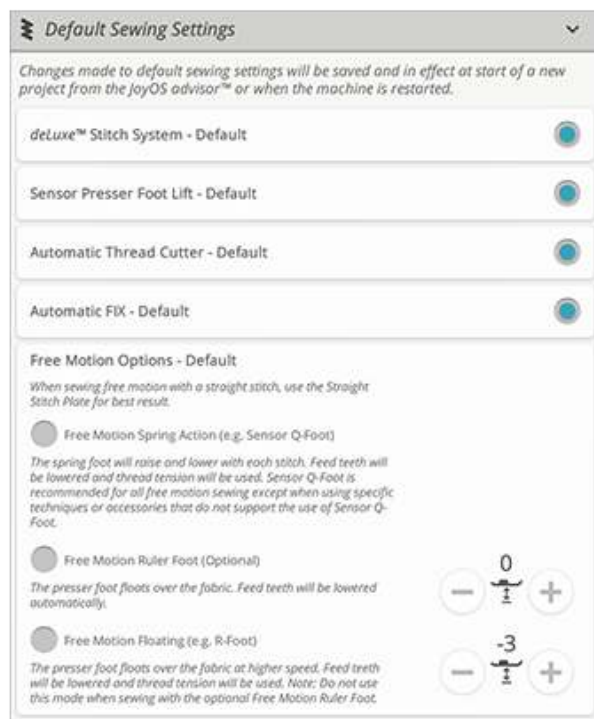

Default Embroidery Settings

All settings made in the default embroidery settings will be saved, even when turning your machine off.

deLuxe™ Stitch System – Default

When selected the *deLuxe™* stitch system will automatically be selected in the temporary embroidery settings for all new projects loaded from the JoyOS ADVISOR™ feature. For more information see the description in the temporary embroidery settings.

Thread Cut Options – Default

When selected the thread cut option will automatically be selected in the temporary embroidery settings for all new projects loaded from the JoyOS ADVISOR™ feature. For more information see the description in the temporary embroidery settings.

Embroidery Pivot Height – Default

If the embroidery pivot height is set in default embroidery settings it will automatically be set to this value in the temporary embroidery settings for all new projects loaded from the JoyOS ADVISOR™ feature. For more information see the description in the temporary embroidery settings.

My Hoops

Select your preferred hoops and selected hoops will be displayed first in the hoop selection list.

When you first load a design, the machine will select the most suitable hoop among the ones you have selected in my hoops.

Note: In the hoop list you will find that some hoop sizes are followed by a letter. These are specialty hoops. For example, E stands for endless hoop, T for texture hoop and M for metal hoop.

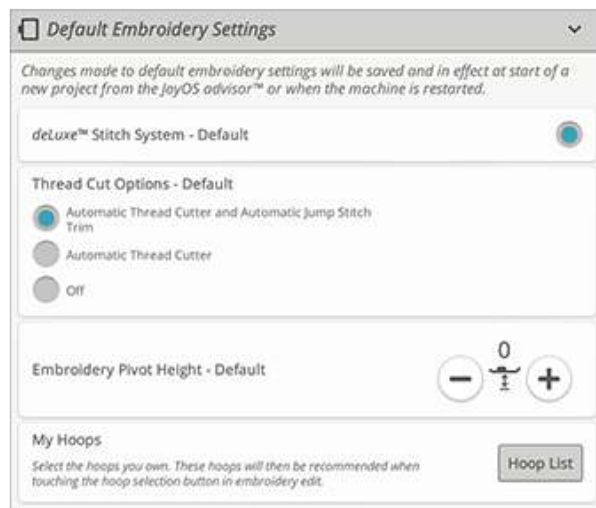

Machine Settings

All settings made in the machine settings will be saved, even when turning your machine off.

Language

Select your desired language on the screen. All texts in the machine will be changed.

Audio Volume

Change the audio volume using the slider bar. All sounds in the machine will be affected when the audio volume is changed. When the slider is all the way to the left, the volume is muted.

Audio Repeat

When active, the signal for some warning alerts or attention pop-up messages will be repeated in intervals until the pop-up is closed.

Machine Nickname

Touch to select a nickname for your machine. This can be useful when owning more than one machine, to distinguish one machine from another when working in *mySewnet*[™]. The name will be shown on the screensaver.

Color Theme

Change the color theme of the machine screen. Choose between four color theme options. This will change the color of the screen background, menus, and programs.

Note: To change the background color of your embroidery area please see Background Color

Lock Screen

If there is the possibility of bumping the screen and changing the stitch or settings while sewing, it is easy to lock the screen.

When selected, the screen is automatically locked whenever it is inactive for ten seconds. A pop-up is shown on the screen and will remain locked until you touch OK in the pop-up.

LED Work Light Brightness

Adjust the brightness of the LED lights to adapt to the light conditions in your sewing room. Simply move the slider to the right to make the LED lights brighter or to the left to make them less bright.

Units

Touch millimeter or inch to set the measurement unit you prefer.

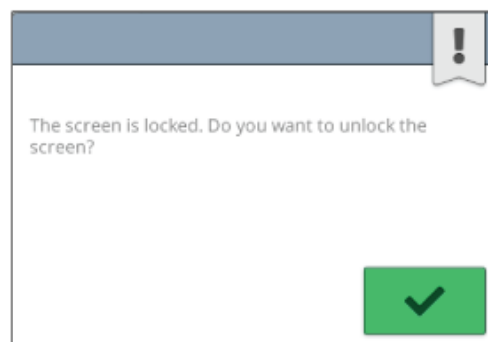
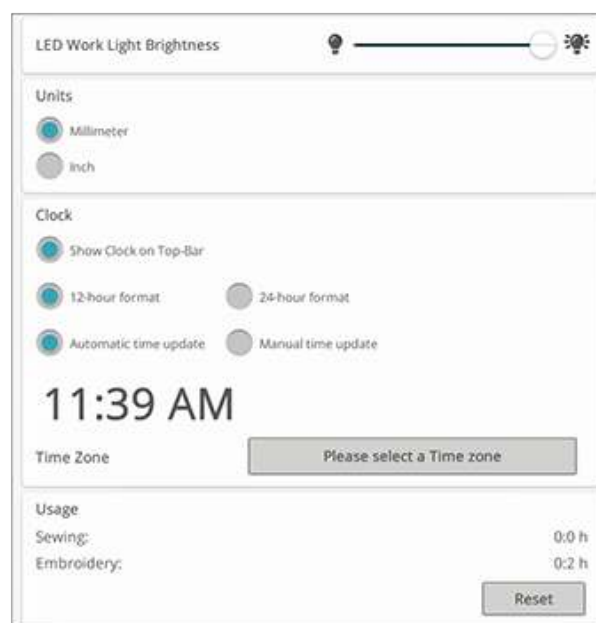

Clock Settings

In clock settings you will find the different settings connected to the clock; select how the clock should be displayed (visible on the top-bar, show a 12- or a -24 hour format) and if you want the clock to be updated automatically or be done manually.

This is also where you set your time zone. The clock is set to UTC (Coordinated Universal Time) standards. For example London is UTC time +/- 0 hours, New York is UTC -5 hours and Sydney is UTC +10 hours. Scroll through the time zones to find the time zone you are in.

Clock Functions

If you have chosen to show the clock in the top-bar, touch the clock to open further clock functions. Here, you can set an alarm, find a stopwatch and see for how long your machine has been sewing since you last reset the timer. Touch the “Reset” button to reset the Stopwatch and/or Sewing time.

Usage

Shows the number of hours sewn on the machine since you last reset the timer. You can reset the counter by touching “Reset”.



WiFi Settings

Select the WiFi settings on your machine. In WiFi settings you can activate/deactivate WiFi on your machine, search for available networks and connect. If connected to a network with Internet access the latest firmware update will always be available. When WiFi is connected and you have logged in to the *mySewnet*TM cloud, all your saved files in the machine will synchronize with the *mySewnet*TM cloud.

Read more about the possibilities with WiFi connection in your machine in the WiFi chapter.



mySewnetTM Settings

In the *mySewnet*TM settings you can sign in to the *mySewnet*TM cloud or change the user on the machine. You will also be able to create a new user. With a *mySewnet*TM account you will be able to access all of the *mySewnet*TM services.

Read more about the possibilities with *mySewnet*TM in *mySewnet*TM services.

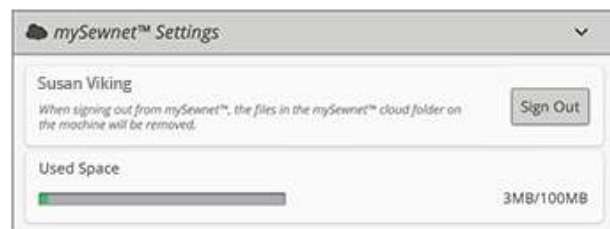

Machine Information

Machine information contains technical machine information such as: machine serial number, machine MAC address and current firmware. In machine information you can clear user account and files.



I2 File Manager

File Manager – Overview

The file manager is used to open design files, font files and stitch files. Store your saved files in the *mySewnet™* cloud folder or to a USB device connected to your machine.

You can expand the file manager window to fullscreen by touching the file manager tab again.

Touch the minimize button to minimize the file manager.

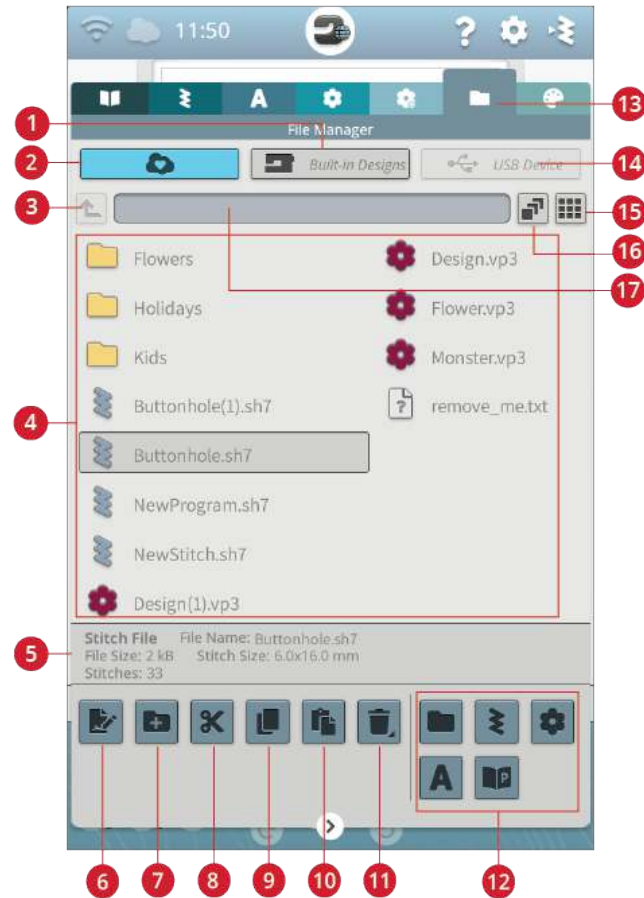

1. Built-in designs
2. *mySewnet™* cloud folder
3. Move up one folder
4. Selection area
5. File information
6. Rename file or folder

7. Create new folder
8. Cut
9. Copy
10. Paste
11. Delete
12. Filter files

13. File manager
14. USB device
15. List/thumbnail view
16. Multi-select
17. Current folder

File Formats

Your machine can load the following file formats:

- .VP3, .SHV, .DHV, .VIP, .HUS, .PEC, .PES, .PCS, .XXX, .SEW, .JEF, .EXP, .10* and .DST (embroidery files)
- .SH7 (stitch file)
- .VF3 (embroidery font file)
- .JOS (JoyOS ADVISOR™ project files)

Note: Some versions of the embroidery files are not fully supported by your machine.

Browse File Manager

To open file manager, touch the file manager button. Touch the button again to enlarge the file manager on the screen.

Store your designs, fonts and stitches in the *mySewnet™* cloud folder or to a USB device connected to the USB ports. The USB device button is only available when a USB device is connected to the machine.

To display the content, touch one of the following buttons: *mySewnet™* cloud folder, built-in designs or USB device. Swipe with your finger from the right to the left to scroll and view the content. Design files and font files are displayed as thumbnail images or with an icon.



File manager button with expand option



mySewnet™ cloud folder



Built-in designs



USB device



1. Stitch file icon

2. Design file icon

Open a File or Folder

Touch a file to read information about the file in the file information area. Touch & hold the file to load it.

If you load an embroidery font file, it will be loaded into program embroidery text. If you load a stitch font file, it will be loaded into program.

Touch & hold on a folder to open it. The content of the folder will be shown in the selection area. The path of an open folder is written in the current folder area.

Multi-Select

If you want to select several designs, stitches or fonts at one time, touch the multi-select button. While multi-select is selected, touch the files you want to use. Copy and paste the selected files e.g. to another folder in file manager.

Note: If trying to load a combination of files/folders that is not possible to load to the same destination a pop-up message will be shown.



Move Up One Folder Level

Use the move up one folder level button to step up through the levels of folders. You can step up all the way to the first level. In the selection area you will see the files and folders for each level as you step up. Touch & hold on a folder to open it.



List/Thumbnail View

Touch the list/thumbnail view button to toggle between showing the files in a list or as thumbnail icons.



mySewnet™ Cloud Folder

Save designs, stitches and fonts to the *mySewnet*™ cloud folder on the machine. If you are signed in to a *mySewnet*™ account and connected to *mySewnet*™ your saved files will be synchronized automatically with the *mySewnet*™ cloud. Read more about the *mySewnet*™ cloud in the *mySewnet*™ cloud section.



Built-in Designs

Built-in designs contains the designs that are stored in the permanent sewing machine memory. No files can be added to or removed from the built-in designs. You can also access the built-in designs in the design menu.



USB Device

The USB device button is only active when a USB device is connected to the machine. Touch the USB device button to display all of the connected devices. Touch a USB device to explore it.



Organize

Below are instructions on how to organize your files in file manager.

Create New Folder

Touch the create new folder button to create a new folder in the current position. Enter a name for your folder.



Rename a File or Folder

To change the name of a file or folder, touch to select it and then touch the rename file or folder button. Enter the new name for a file or folder.



Move a File or Folder

Use cut and paste to move file(s) or folder(s) to another location.

Select the file(s) or folder(s) and then touch the cut button. Open the folder where you want to place the selection. Touch the paste button. The file(s) or folder(s) is removed from its original location and now stored in the new folder.

Note: Activate multi-select to be able to select and move more than one file and/ or folder the same time.



Cut



Paste

Copy a File or Folder

Use copy and paste to copy file(s) or folder(s) to another location.

Select the file(s) or folder(s), then touch the copy button. Open the folder where you want to place the selection. Touch the paste button. The file(s) or folder(s) is now stored in the new folder and the original file(s) or folder(s) still exists in the previous folder.

Note: Activate multi-select to be able to select and move more than one file and/ or folder at the same time.



Copy



Paste

Delete a File or Folder

To delete a file or folder, select it and touch the delete button. A pop-up message will appear so that you can confirm the deletion. If a folder is deleted, all files within the folder are deleted as well.

To delete all files and folders shown in the active folder, touch & hold the delete button for a few seconds. A pop-up message will appear so that you can confirm the deletion of all content.



Toggle Between Edit and Filter View

If you expand file manager on the screen, all buttons used for organizing are shown at the same time in the lower part of file manager.

If file manager is not expanded on the screen, touch the toggle switch to toggle between showing the buttons for editing and buttons for filtering. If a filter button has been selected and the switch is set to edit view, an exclamation mark appears to remind you that files have been filtered and as a result all files in current folder may not be visible on the screen.



Filter Files

If you have a lot of content in a folder you can filter specific files in the current view. Touch one or several of the filter buttons to only show, e.g. designs and/or stitches. The content shown in the selection area will change depending on the selected button(s).

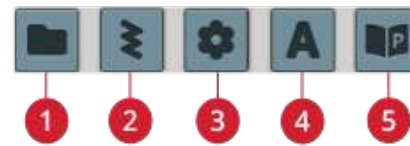

1. Filter folders
2. Filter stitches
3. Filter designs
4. Filter fonts
5. Filter JoyOS ADVISOR™ project files

File Manager Pop-up Messages

Delete File or Folder

When deleting a file or folder, you will need to confirm the deletion in the pop-up message that appears on screen. This will prevent you from deleting anything by mistake.

Folder Already Exists

You cannot create a new folder with the same name as another folder on the same level. Create your folder on a different level or enter a different name for the folder.

Available Space is Low

When only a small amount of space is left, your machine will alert you one time. If you continue to fill the space, it will not remind you again, until the space is completely full. Move your files to a USB device by using the cut and paste functions to free up space.

The Combination of Selected File Types Cannot be Loaded

Some file combinations can not be loaded to the same destination using multi-select.

13 Maintenance

Cleaning the Machine Exterior

To keep your sewing machine operating well, clean it often. No lubrication (oiling) is needed.

Wipe the exterior surface of your machine with a soft cloth to remove any dust or lint built up.

Wipe the screen with a clean, soft and slightly damp microfiber cloth.

Removing the Needle Plate and Cleaning the Bobbin Area

 Lower the feed teeth by touching the presser foot up and extra lift button. Turn off the machine.

- Remove the presser foot and slide off the bobbin cover.
- Place the screwdriver under the needle plate as shown in the picture and gently turn the screwdriver to pop off the needle plate.
- Clean the feed teeth with the brush found with the accessories.

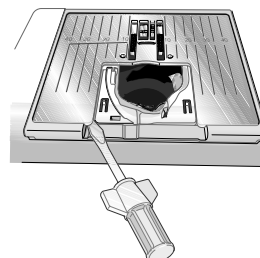

Cleaning Under the Bobbin Area

Clean the area under the bobbin case after sewing several projects or any time you notice an accumulation of lint in the bobbin case area.

- Remove the bobbin case holder (A) covering the front part of the bobbin case by lifting it up.
- Remove the bobbin case (B) by lifting it up.
- Clean with the brush.

 Use caution when cleaning around the automatic thread cutter knife (C).

- Put the bobbin case and the bobbin case holder back in place.

Note: Do not blow air into the bobbin case area. The dust and lint will be blown into your machine.

Note: When using optional accessories like cutwork and/or felting needles, it is necessary to clean the bobbin area after each embroidered design/project.

Note: Regularly clean the lint and threads from the bobbin area. Check the area when changing the needle plate.

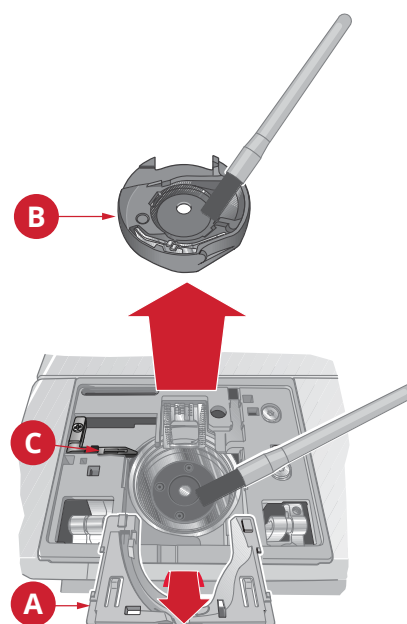

Replacing the Needle Plate

- With feed teeth lowered, place the needle plate so that it fits into the notch at the back (A).
- Press the needle plate down until it clicks into place.
- Slide on bobbin cover.

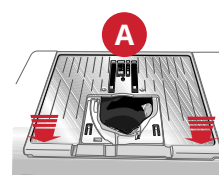

Troubleshooting

In this troubleshooting guide you will find solutions to the problems you may have with your machine. For further information please contact your local authorized

HUSQVARNA® VIKING® retailer who will be happy to help you.

General Problems

| | |
|---|---|
| Bobbin alarm does not work | Clean lint from bobbin area and use only the original HUSQVARNA® VIKING® bobbins approved for this model. |
| Thread cutter does not cut the thread | Remove needle plate and clean lint from bobbin area. Enable automatic thread cutter in the settings menu. |
| Fabric does not feed | Make sure the machine is not set for free motion sewing. Make sure the feed teeth are not set to down in the settings menu. |
| Wrong stitch, irregular or narrow stitch | Deactivate twin needle or stitch width safety in the settings menu. |
| The needle breaks | Insert needle correctly as described, see Changing the Needle, page 33. Use a needle suitable for selected fabric. See Selecting Correct Thread/Needle Combination, page 35. |
| The machine will not sew | Check that all plugs are securely inserted into the machine and the wall socket. |
| Poor sewing/embroidery result | Use only accessories designed for your DESIGNER SAPPHIRE™ 85 machine. Follow the on-screen recommendations. |
| The sewing and embroidery machine screen and/or function buttons do not respond to touch | The sockets and function buttons on the machine can be sensitive to static electricity. If the screen does not respond to touch, turn the machine OFF and then ON again. If the problem persists, contact your authorized HUSQVARNA® VIKING® retailer. |
| When sewing in heavy and/or dense fabrics the machine emits a distinct sound different from the sound normally generated when sewing. | The sound is not an indication of malfunction. The machine is equipped with a pulsating needle piercing feature that helps the needle to penetrate heavy and/or dense fabrics. The sound is caused when the presser foot and fabric lift with the needle. Increase the presser foot pressure to prevent the foot from lifting. If the sound does not seem to be related to the pulsating needle piercing feature, contact your authorized HUSQVARNA® VIKING® retailer for service. |

The Machine Skips Stitches

| | |
|--------------------------------------|---|
| Did you insert the needle properly? | Insert needle correctly as described, see Changing the Needle, page 33. |
| Did you insert a wrong needle? | Use needle system 130/705 H. Use a needle suitable for selected fabric and thread. See Selecting Correct Thread/Needle Combination, page 35. |
| Is the needle bent or blunt? | Insert a new needle. |
| Did you thread the machine properly? | Remove the thread completely and rethread the machine, see Horizontal Spool Pin, page 33. |

| | |
|---|------------------------------|
| Is the correct presser foot used? | Attach correct presser foot. |
| Is the needle too small for the thread? | Change the needle. |
| Is the fabric moving up and down with the needle when free motion sewing or embroidering? | Attach Sensor Q-Foot. |

Needle Thread Breaks

| | |
|--|---|
| Did you insert the needle properly? | Insert needle correctly, see Changing the Needle, page 33. |
| Did you insert a wrong needle? | Use needle system 130/705 H. Use a needle suitable for selected fabric and thread. See Selecting Correct Thread/Needle Combination, page 35. |
| Is the needle bent or blunt? | Insert a new needle. |
| Did you thread the machine properly? | Remove the thread completely and rethread the machine, see Horizontal Spool Pin, page 33. |
| Is the needle too small for the thread? | Change the needle to the proper size for the thread. |
| Are you using poor thread with slubs or thread which has become dry? | Change to a new high quality thread purchased from an authorized HUSQVARNA® VIKING® retailer. |
| Is the best spool pin position used? | Try a different spool pin position (vertical or horizontal). |
| Is the needle plate hole damaged? | Change the needle plate. |
| Is the thread tension too high for selected thread? | Lower the thread tension in small increments until problem is solved. |

Bobbin Thread Breaks

| | |
|-------------------------------------|--|
| Is the correct bobbin used? | Use only the original bobbins approved for this model. |
| Did you insert the bobbin properly? | Check the bobbin thread. |
| Is the needle plate hole damaged? | Change the needle plate. |
| Is the bobbin area full of lint? | Clean lint from bobbin area and use only the original bobbins approved for this model. |
| Is the bobbin wound correctly? | Wind a new bobbin. |

The Seam Has Uneven Stitches

| | |
|---|--|
| Is the thread tension correct? | Check needle thread tension. Remove the thread completely and rethread the machine, see Horizontal Spool Pin, page 33. |
| Is the thread you are using thick or slubbed? | Change the thread. |
| Is the bobbin thread evenly wound? | Check bobbin winding. |
| Is a correct needle used? | Insert a proper needle correctly as described, see Changing the Needle, page 33. Use a needle suitable for selected fabric. See Selecting Correct Thread/Needle Combination, page 35. |

The Machine Does Not Feed or Feeds Irregularly

| | |
|---|---|
| Did you thread the machine properly? | Remove the thread completely and rethread the machine, see Horizontal Spool Pin, page 33. |
| Has sewing lint collected between the feed teeth? | Remove the needle plate and clean the feed teeth with the brush. |
| Is the free motion setting on? | Turn off free motion setting in sewing mode. |
| Are the feed teeth set to down? | Make sure the feed teeth are not set to down in the settings menu. |
| Is the correct presser foot used? | Attach correct presser foot. |

Thread Loops are Forming on the Underside of the Embroidery Design

| | |
|---|--|
| Has the embroidery built up too much to move freely under the presser foot? | Attach Sensor Q-Foot. If using the R-Foot, increase the embroidery pivot height in settings menu in small increments until the problem is solved. |
|---|--|

The Embroidery Design Is Distorted

| | |
|--|--|
| Is the fabric hooped properly? | The fabric must be tightly hooped. For larger hoops, use hoop clips. |
| Is the inner embroidery hoop properly inserted into the outer embroidery hoop? | Hoop the fabric in such a way that the inner hoop exactly matches the outer hoop. |
| Is the area around the embroidery arm and hoop free? | Clear area around the embroidery unit. |
| Is the hoop attached properly? | Make sure the hoop connector is inserted all the way into the hoop attachment on the embroidery arm. |

The Embroidery Design Has Puckered

| | |
|---|---|
| Did you stabilize your fabric sufficiently? | Ensure you use the proper stabilizer for your technique or fabric type. |
|---|---|

The Machine Will Not Embroider

| | |
|----------------------------------|--|
| Is the embroidery unit attached? | Make sure that the embroidery unit is properly attached into the socket. |
| Is the wrong hoop attached? | Slide on the correct hoop. |

Troubleshooting Connectivity

The Machine Cannot Connect to a WiFi Network

| | |
|--|---|
| The machine will not connect to a WiFi network | <p>Make sure that WiFi is enabled on your machine. Touch the WiFi button on the top bar or go to WiFi settings.</p> <p>Make sure that the machine detects a signal from your WiFi network. If there is no signal, move the machine closer to the WiFi router.</p> <p>Make sure you have selected your WiFi network.</p> |
| The machine has no Internet connection | Make sure that your WiFi router has access to the Internet. |
| The WiFi network is password protected | Make sure that you have selected your WiFi network and entered the correct password. If you do not know the password, contact the administrator of your network. |

The Machine Cannot Synchronize with the *mySewnet*[™] Cloud

| | |
|--|--|
| The machine cannot synchronize files with the <i>mySewnet</i> [™] cloud | <p>Make sure that you have a working WiFi connection.</p> <p>Make sure that you have signed in to your <i>mySewnet</i>[™] account. New <i>mySewnet</i>[™] accounts are registered in the machine or at husqvarnaviking.mysewnet.com</p> <p>Make sure that there is available space on the <i>mySewnet</i>[™] cloud.</p> <p>If the <i>mySewnet</i>[™] cloud is not accessible although you have checked the WiFi connection, the server could temporarily be unavailable. Please try again later.</p> |
|--|--|

Service

Have Your Sewing Machine Serviced Regularly by Your Local Authorized Retailer!

If you have followed this troubleshooting information and still have problems, contact your retailer. It may be helpful to bring the fabric, thread and stabilizer you are using with you. If you have a stitch out that shows the problem, please bring that as well. A sewing sample will often give better information than words and help your technician diagnose the problem.

Non-Original Parts and Accessories

The warranty does not cover any defect or damage caused by use of non-original accessories or parts.

Technical Specification

DESIGNER SAPPHIRE™ 85 machine

| | |
|----------------------------------|------------------------------|
| Rated voltage | 100–120V/200–240V, 50–60Hz |
| Nominal consumption | <100W |
| Light | LED lamps |
| Sewing speed | 1050 stitches/minute maximum |
| Foot control model | FR5 |
| Safety class | I |
| WiFi module: | |
| Frequency | 2.4GHz band 802.11 b/g/n |
| Transmitting power | +17 dBm |
| Receiver sensitivity | -97 dBm |
| Net weight (kg), machine only | 10 |
| Net weight (kg), embroidery unit | 3.7 |
| Machine dimensions: | |
| Length (mm) | 485 |
| Width (mm) | 240 |
| Height (mm) | 300 |

- The technical specifications and this owner's manual can be changed without prior notice.

Index

| | |
|-------------------------------|----|
| 4-Way Stitches – Menu S | 92 |
| 4-Way Stitches Exercise | 92 |
| 8-Way Stitches – Menu T | 93 |

A

| | |
|---|----------|
| Accessories | 16 |
| Accessory guide | 71 |
| Accessory socket | 13 |
| Accessory Tray | 13 |
| Active position | 139 |
| Add a Letter | 111 |
| Adjust a Stitch or Letter | 140 |
| Adjust the Entire Program | 141 |
| Adjust Thread Tension/Thread Portioning | 80 |
| All Purpose Sewing Thread | 31 |
| Alphabets | 23 |
| Alternative switch bar | 75 |
| Apps | 57 |
| Arrange | 97, 102 |
| Attach Hoop | 135 |
| Attached Needle Plate | 123 |
| Attaching the Dual Feed | 39 |
| Attaching the Sensor One-Step Buttonhole Foot | 39 |
| Attaching the Sensor Q-Foot | 39 |
| Attention! | 94, 136 |
| Audio Repeat | 154 |
| Audio Volume | 154 |
| Auto Smart Save | 130, 136 |
| Automatic Buttonhole | 88 |
| Automatic FIX | 146–147 |
| Automatic FIX – Default | 152 |
| Automatic Jump Stitch Trim | 151 |
| automatic needle threader | 94 |
| Automatic thread cutter | 146 |
| Automatic Thread Cutter | 147, 150 |
| Automatic Thread Cutter – Default | 152 |
| Auxiliary spool pin | 12 |
| Available Space is Low | 163 |
| Available techniques of chosen group | 71 |

B

| | |
|---|----------|
| Balance | 83 |
| Balance stitch | 75 |
| Base plate | 12 |
| Basic Gestures for the Multi-Touch Screen | 24 |
| Basic Sewing Techniques | 86 |
| Baste | 86 |
| baste around design | 134 |
| baste around hoop | 134 |
| Basting options | 122 |
| Basting Options | 123, 134 |

| | |
|--|---------|
| Blind Hem | 87 |
| Blindhem Foot D | 17 |
| bobbin case | 165 |
| bobbin case holder | 165 |
| Bobbin cover | 12 |
| Bobbin Thread Breaks | 167 |
| Bobbin Thread Low | 94, 135 |
| Bobbin winder | 12 |
| Bobbin Winding | 37 |
| Bobbin winding lever | 12 |
| Bobbin winding thread guides | 12 |
| Bobbins | 16 |
| Browse File Manager | 159 |
| Brush | 16 |
| Built-in designs | 158–159 |
| Built-in Designs | 160 |
| Built-in needle threader handle | 13 |
| Built-in ruler with button ruler | 12 |
| Built-in USB ports | 12 |
| Button reed | 16 |
| Button size | 108 |
| Button Size | 79 |
| Buttonhole Foot C | 17 |
| Buttonholes | 88 |

C

| | |
|--|------------------|
| Cancel | 46, 82, 107, 142 |
| Cancel program | 139 |
| Candlewicking stitch (narrow or wide) | 116 |
| Cannot Use the Automatic Needle Threader | 94 |
| Center marks | 42 |
| Center/Remove Hoop Position | 126 |
| Change More Than One Color Block | 110 |
| Change Needle | 136 |
| Change Thread | 135 |
| Changeable Straight Stitch Foot Plate | 39 |
| Changeable Zigzag Foot Plate | 39 |
| Changing the Needle | 33 |
| Changing the Presser Foot | 38 |
| Changing to Straight Stitch Plate | 40 |
| Check Upper Thread | 94, 135 |
| Cleaning the Bobbin Area | 165 |
| Cleaning the Machine Exterior | 165 |
| Cleaning Under the Bobbin Area | 165 |
| clear user account | 156 |
| Close | 65 |
| Color block | 122 |
| color block list | 130 |
| Color block list | 122 |
| Color Block List | 124 |
| Color block merge | 122 |
| color block order | 124 |
| Color block sort | 122 |
| Color Block Sort | 132 |

| | |
|--|-------------------|
| color number..... | 130 |
| Color Options | 123, 132 |
| color order..... | 130 |
| Combination repeat..... | 113 |
| Common Functions..... | 46 |
| complimentary software | 151 |
| Complimentary Software (PC and MAC)..... | 54 |
| Confirm | 82, 142 |
| Connect the Embroidery Unit..... | 43 |
| Connect the foot control cord..... | 26 |
| Connect the power cord..... | 26 |
| Connect to a Network with WiFi..... | 28 |
| Connect to <i>mySewnet</i> [™] Cloud..... | 28 |
| Continue | 62 |
| Control wheel..... | 97 |
| Copy..... | 158, 161 |
| Copy a File or Folder..... | 161 |
| Corded Buttonhole..... | 88 |
| Corner check..... | 122 |
| Corner Check..... | 125 |
| Create | |
| New Program | 139 |
| Create a Text..... | 111 |
| Create new folder..... | 82, 107, 142, 158 |
| Create New Folder | 161 |
| current embroidery settings..... | 123 |
| current firmware | 156 |
| Current folder | 158 |
| Current Stitch Position..... | 125 |
| Cursor..... | 138, 140 |
| Cursor arrows..... | 111 |
| Cut..... | 158, 161 |
| Cut and Remove the Thread Tail..... | 136 |

D

| | |
|---|------------------------|
| Decorative Stitch Foot B..... | 17 |
| Default Embroidery Settings..... | 153 |
| Default Sewing Settings..... | 152 |
| Delete | 103, 138, 140, 158 |
| Delete a File or Folder | 161 |
| Delete a Letter..... | 111 |
| Delete a Stitch or Letter | 140 |
| delete all | 113 |
| Delete File or Folder..... | 163 |
| Delete last..... | 113 |
| <i>deLuxe</i> [™] stitch system | 146 |
| <i>deLuxe</i> [™] Stitch System..... | 80, 124, 129, 146, 149 |
| <i>deLuxe</i> [™] Stitch System – Default..... | 152–153 |
| Denim Needle | 32 |
| Design appliqué | 97 |
| Design Appliqué | 116 |
| Design Appliqué Exercise..... | 116 |
| Design categories | 98 |
| Design file | 159 |
| Design information | 98 |
| Design menu..... | 98, 113 |

| | |
|---|---------------|
| Design menu name..... | 98 |
| design number..... | 124, 130 |
| Design positioning | 122 |
| Design Positioning | 127 |
| Design Positioning Wizard..... | 128 |
| Design shaping..... | 97 |
| Design Shaping..... | 113 |
| Design Shaping Exercise | 113 |
| design stitch out order..... | 101 |
| Design stitch out order..... | 98 |
| Design Stitch Out Order | 106 |
| DESIGNER [™] Crown Hoop (260x200) | 16 |
| DESIGNER [™] Royal Hoop (360x200) | 16 |
| DESIGNER SAPPHIRE [™] 85 Sampler book..... | 136 |
| DESIGNER SAPPHIRE [™] 85 Sampler Book | 43 |
| DESIGNER [™] Splendid Square Hoop (120x120)..... | 16 |
| Designs | 43 |
| Dimensional Stitches – Menu L..... | 89 |
| Duplicate..... | 103, 138, 140 |
| Duplicate a Stitch or Letter | 140 |
| duplicate last design..... | 113 |

E

| | |
|--|---------|
| Edge/Quilting guides | 16 |
| Edging Foot J..... | 17 |
| Edit | 97 |
| Edit an Existing Design or Text..... | 108 |
| Edit Buttonhole..... | 108 |
| Edit Existing Shape | 114 |
| Edit Stitch or Lettering Program..... | 140 |
| Edit stitch program | 75 |
| Embellished Stitches – Menu N..... | 90 |
| EMBROIDERY ADVISOR [™] – Overview | 70 |
| embroidery area | 106 |
| Embroidery area | 97, 122 |
| Embroidery arm | 13, 42 |
| Embroidery Combination is too Complex | 119 |
| Embroidery Edit – Overview | 97 |
| Embroidery Edit Pop-up Messages | 119 |
| embroidery files | 159 |
| embroidery font file..... | 159 |
| Embroidery foot type | 149 |
| Embroidery Foot Type..... | 150 |
| Embroidery hoop attachment..... | 13, 42 |
| Embroidery hoop connector..... | 42 |
| Embroidery Hoop Overview | 42 |
| Embroidery Needle | 32 |
| Embroidery Pivot Height – Default..... | 153 |
| Embroidery Stitch Out – Overview..... | 122 |
| Embroidery Stitch Out Pop-up Messages | 135 |
| Embroidery technique groups | 70 |
| Embroidery Technique Groups | 70 |
| Embroidery techniques | 70 |
| Embroidery Thread..... | 31 |
| Embroidery Unit..... | 13, 42 |
| Embroidery unit plug..... | 13, 42 |

| | |
|--|--------|
| Embroidery unit release button | 13, 42 |
| Embroidery unit socket | 13 |
| Embroidery/Darning Foot R | 18 |
| Exceeded Maximum Number of Stitches..... | 119 |
| EXCLUSIVE SENSOR SYSTEM™ | |
| EXCLUSIVE SENSOR SYSTEM..... | 80 |

F

| | |
|--|------------------------------|
| Fabric selected..... | 75 |
| Fabric selection..... | 66 |
| Fabric Selection | 67 |
| Fast forward..... | 65 |
| FAT32..... | 27 |
| Feathered stitch (narrow or wide)..... | 116 |
| Feed teeth options..... | 146 |
| Feed Teeth Options | 148 |
| Felt pad | 16 |
| File Formats..... | 159 |
| File information..... | 158 |
| File manager..... | 75–76, 98, 113, 139, 158–159 |
| File Manager | 100 |
| File Manager – Overview..... | 158 |
| File Manager Pop-up Messages..... | 163 |
| File name..... | 82, 107, 142 |
| Filter designs | 162 |
| Filter files | 158 |
| Filter Files..... | 162 |
| Filter folders..... | 162 |
| Filter fonts..... | 162 |
| Filter JoyOS ADVISOR™ project files..... | 162 |
| Filter stitches..... | 162 |
| Firmware Update Using a USB Device | 53 |
| Firmware Update Using WiFi..... | 53 |
| FIX command..... | 138, 141 |
| FIX function..... | 14 |
| Fixed design angle..... | 113 |
| Fixed Design Angle | 115 |
| Fixed letter angle..... | 111 |
| Fixed Letter Angle..... | 112 |
| floating foot..... | 150 |
| Folder Already Exists..... | 163 |
| Font menu..... | 75–76, 98, 111, 139 |
| Free arm..... | 13 |
| Free Arm..... | 28 |
| free motion floating..... | 84 |
| Free motion options | 75 |
| Free Motion Options | 84 |
| Free Motion Options – Default | 152 |
| free motion spring action..... | 84 |
| Full screen on/off..... | 65 |
| Function Buttons | 14 |

G

| | |
|------------------------|-----|
| General Problems | 166 |
|------------------------|-----|

| | |
|---|----------|
| Getting Started to Embroider..... | 96 |
| Getting Started to Sew | 74 |
| Getting Started With WiFi | 52 |
| Getting Started with WiFi and <i>mySewnet</i> ™ Cloud | 28 |
| Glide plates recommendation..... | 77 |
| GO..... | 108 |
| Go to embroidery stitch out..... | 98 |
| go to first..... | 138, 140 |
| go to last | 138, 140 |
| Go to stitch..... | 122 |
| Grid/background color..... | 97 |

H

| | |
|---|-----|
| Handle | 13 |
| Handwheel..... | 12 |
| Hem | 87 |
| Hidden Network..... | 52 |
| high signal strength..... | 52 |
| Highlight current color block | 122 |
| Highlight Current Color Block | 133 |
| Holes for needles | 13 |
| Home Screen..... | 48 |
| Home Screen— Overview..... | 60 |
| Hoop clips | 16 |
| hoop connector | 135 |
| Hoop position options..... | 122 |
| Hoop Position Options..... | 125 |
| Hoop selection | 97 |
| Hoop Selection..... | 102 |
| Hoop the Fabric | 44 |
| Horizontal Spool Pin | 33 |
| How to Attach the Guide | 40 |
| How to Select Designs | 100 |
| HUSQVARNA® VIKING® Embroidery Cutwork Needle Kit | 136 |
| HUSQVARNA® VIKING® Felting Embroidery Set | 136 |

I

| | |
|---|-----|
| Important Needle Information..... | 32 |
| Important Resize Information..... | 118 |
| Included Accessories | 16 |
| Included Hoops..... | 16 |
| Inner hoop..... | 42 |
| Insert a Stitch or Letter | 140 |
| Inserting the Bobbin..... | 38 |
| Installation of <i>mySewnet</i> ™ Cloud Sync Tool for Computer .. | 57 |
| Interchangeable Dual Feed..... | 18 |
| Interchangeable Dual Feed Foot | 39 |

J

| | |
|-----------------------------|---------------|
| JoyOS ADVISOR™ feature..... | 116, 127, 146 |
|-----------------------------|---------------|

| | |
|--|------------------|
| JoyOS ADVISOR™ project | 146 |
| JoyOS ADVISOR™ project files | 159 |
| JoyOS ADVISOR™ project menu | 75, 98, 139 |
| JoyOS ADVISOR™ project viewer..... | 75, 97, 122, 139 |
| JoyOS ADVISOR™ Project Viewer – Overview | 64 |
| Jump stitch trim commands | 151 |

K

| | |
|----------------------------------|-----|
| keyboard..... | 139 |
| keypad..... | 140 |
| Knit fabric | 67 |
| Knowledge Center – Overview..... | 71 |

L

| | |
|--|--------|
| Language | 154 |
| Leather..... | 67 |
| LED light | 12 |
| LED lights..... | 154 |
| LED Lights..... | 28 |
| LED Work Light Brightness..... | 154 |
| Level adjustment feet..... | 13, 42 |
| Lid | 12 |
| List and thumbnail view | 82 |
| List/thumbnail view | 158 |
| List/Thumbnail View | 160 |
| Load a Design | 99 |
| Load a Font | 100 |
| Load a Stitch | 100 |
| Load a Stitch or Letter From Another Location..... | 76 |
| Load Smart Save | 63 |
| Lock Screen | 154 |

M

| | |
|---------------------------------------|-----------------------|
| Machine Information..... | 156 |
| machine MAC address | 156 |
| Machine Overview | 12 |
| machine serial number | 156 |
| Machine Settings | 154 |
| Main spool pin..... | 12 |
| Manual Buttonhole..... | 88 |
| Manual Thread Cutter..... | 28 |
| medium signal strength | 52 |
| microfiber cloth | 165 |
| Minimize selection area | 98 |
| Minimize/expand color block list..... | 122 |
| Minimize/expand selection area..... | 75, 139 |
| Mirror end to end | 75, 81, 104, 138, 140 |
| Mirror side to side..... | 75, 81, 104, 138, 140 |
| Mirroring..... | 81 |
| Monochrome | 122, 132 |
| Move a File or Folder..... | 161 |

| | |
|--|-------------|
| Move Locked Point on Fabric | 128 |
| Move to Hoop..... | 103 |
| Move up one folder..... | 158 |
| Move Up One Folder Level | 160 |
| Multi select | 109 |
| multi-select | 161 |
| Multi-select | 158 |
| Multi-Select..... | 102, 159 |
| Multi-touch screen | 12 |
| Multipurpose tool | 16 |
| My Hoops | 153 |
| <i>mySewnet</i> ™ | 48, 56 |
| <i>mySewnet</i> ™ account..... | 55, 169 |
| <i>mySewnet</i> ™ Account..... | 55 |
| <i>mySewnet</i> ™ cloud..... | 55, 169 |
| <i>mySewnet</i> ™ Cloud..... | 56 |
| <i>mySewnet</i> ™ cloud folder..... | 55, 158–159 |
| <i>mySewnet</i> ™ Cloud Folder | 160 |
| <i>mySewnet</i> ™ cloud sync tool..... | 55 |
| <i>mySewnet</i> ™ menu..... | 55 |
| <i>mySewnet</i> ™ Menu | 57 |
| <i>mySewnet</i> ™ Services | 55 |
| <i>mySewnet</i> ™ Settings..... | 156 |

N

| | |
|---|-----|
| Needle Area | 13 |
| Needle bar | 13 |
| Needle clamp | 13 |
| Needle Combination..... | 35 |
| Needle plate..... | 12 |
| Needle recommendation | 77 |
| Needle stop up/down..... | 14 |
| Needle Thread Breaks..... | 167 |
| Needle thread guide..... | 13 |
| Needles | 32 |
| New Program..... | 139 |
| Non-Original Parts and Accessories | 169 |
| Non-Stick Glide Foot H..... | 17 |
| Not a Programmable Stitch..... | 142 |
| Number of stitches in current color block | 122 |
| Number of Stitches in Current Color Block..... | 131 |
| Number of Stitches in Embroidery Combination..... | 131 |

O

| | |
|--|--------------|
| Off..... | 150 |
| Ok..... | 107 |
| OK..... | 46, 116, 139 |
| On-Screen Display of Selected and Non-Selected Color Blocks | 110 |
| ON/OFF switch..... | 26 |
| ON/OFF switch, connectors for power cord and foot control | 12 |
| Open a File or Folder | 159 |

| | |
|-----------------------|-----|
| OpenType™ fonts | 54 |
| Organize..... | 161 |
| Outer hoop..... | 42 |
| Overcast..... | 86 |

P

| | |
|---|----------|
| Pack Away After Sewing..... | 27 |
| Pan..... | 98, 105 |
| Park Position..... | 125 |
| Paste..... | 158, 161 |
| <i>Pinch/Stretch</i> | 24 |
| Play/pause..... | 65 |
| Position..... | 98, 104 |
| Pre-tension thread guide..... | 12 |
| Presser Feet..... | 17 |
| Presser foot..... | 13 |
| Presser foot bar and presser foot ankle | 13 |
| Presser foot down and pivot | 14 |
| Presser foot lift..... | 146 |
| Presser foot recommendation..... | 77 |
| Presser foot up and extra lift | 14 |
| Program | 75, 97 |
| Program – Overview | 138 |
| Program Embroidery Text..... | 111 |
| Program length..... | 138 |
| Program Pop-Up Messages..... | 142 |
| Programmable Button Sew On..... | 89 |
| Project Menu..... | 63 |
| Project Viewer..... | 63 |

Q

| | |
|----------------------------------|----|
| quick help..... | 68 |
| Quick Help..... | 49 |
| Quick release..... | 42 |
| Quick start guide..... | 71 |
| Quick Start Guide | 72 |
| QUILT ADVISOR– Overview..... | 69 |
| Quilter's ¼" Piecing Foot P..... | 17 |
| Quilting technique groups..... | 69 |
| Quilting techniques | 69 |

R

| | |
|---|---------|
| Rear..... | 13 |
| Redo..... | 98, 106 |
| Remaining embroidery time by color block..... | 122 |
| Remaining Embroidery Time by Color Block..... | 131 |
| Removable bobbin holder..... | 13 |
| Remove Sensor One-Step Buttonhole Foot | 94 |
| Remove the Embroidery Unit | 43 |
| Removing the Needle Plate | 165 |
| Rename a File or Folder | 161 |

| | |
|---------------------------------|--------------|
| Rename file or folder | 158 |
| Repeat on/off | 65 |
| Replace a Stitch or Letter..... | 141 |
| Replacing the Needle Plate..... | 165 |
| Resize | 97, 117 |
| Resize Adjustments | 117 |
| Retain Fill Type..... | 117 |
| Retaining screw..... | 42 |
| Return to embroidery edit..... | 122 |
| Return to Embroidery Edit..... | 131 |
| Reverse | 14 |
| Rewind..... | 65 |
| Ribs for fitting the clips..... | 42 |
| Rotate | 98, 104 |
| Rotate Design on Fabric..... | 128 |
| Rotate handle | 97, 113, 116 |

S

| | |
|---|-----------------------|
| Satin stitch (narrow or wide) | 116 |
| Save..... | 75, 97, 138, 142 |
| Save Design | 107 |
| Save Stitch | 82 |
| Save to a USB device | 107, 142 |
| Save to <i>mySewnet</i> ™ cloud folder | 82 |
| Save to the <i>mySewnet</i> ™ cloud folder..... | 107, 142 |
| Save to USB device..... | 82 |
| Scale | 98, 105 |
| Scale handles..... | 97, 113, 116 |
| Screwdriver..... | 16 |
| Seam..... | 86 |
| Seam ripper..... | 16 |
| Select a Stitch or Letter | 76 |
| Select all | 109 |
| Select All | 102 |
| Select Design Exercise | 101 |
| Select equal | 109 |
| Select line positioning | 113 |
| Select Line Positioning..... | 114 |
| Select One Design..... | 101 |
| Select side positioning..... | 113 |
| Select Side Positioning | 115 |
| Select spacing | 111, 113 |
| Select Spacing..... | 112, 114 |
| Select text shape..... | 111 |
| Select Text Shape | 112 |
| Selected embroidery foot type | 122 |
| Selected font information | 111 |
| Selected Foot Type | 123 |
| Selected hoop..... | 122 |
| Selected Hoop | 123 |
| Selecting Correct Thread | 35 |
| Selection area | 75, 82, 107, 142, 158 |
| Selective Thread Cutter | 14 |
| Self-Adhesive Glide Plates | 18 |
| Send design..... | 97 |
| sensor foot pressure | 75 |

| | |
|---|-----------------------|
| Thread color edit | 109 |
| Thread color change | 109 |
| Thread Color Change | 110 |
| Thread color edit | 98 |
| Thread Color Edit..... | 109 |
| thread color number | 124 |
| Thread color spools..... | 122 |
| Thread Color Spools..... | 130 |
| thread cut command..... | 141 |
| Thread cut command..... | 138 |
| Thread cut options | 149 |
| Thread Cut Options | 124, 150 |
| Thread Cut Options – Default..... | 153 |
| Thread cutter..... | 12 |
| Thread cutter for bobbin winding | 12 |
| Thread Loops are Forming on the Underside of the Embroidery Design | 168 |
| thread manufacturer | 124, 130 |
| Thread net | 16 |
| thread portioning | 149 |
| Thread portioning..... | 75, 80, 122, 129, 146 |
| Thread Sensor | 29 |
| Thread take-up lever | 12 |
| thread tension..... | 75, 146, 149 |
| Thread tension | 80, 122, 129 |
| Thread tension disc for bobbin winding..... | 12 |
| Thread tension discs | 12 |
| thread weight..... | 124, 130 |
| Threading for Twin Needle..... | 36 |
| Threading slots | 12 |
| Threading the Upper Thread..... | 33 |
| Threads | 31 |
| To Edit a Created Program | 140 |
| To Select a Locking Point on Screen..... | 128 |
| Toggle Between Edit and Filter View..... | 162 |
| Toggle between list and thumbnail view | 107, 142 |
| Topbar | 47 |
| Total number of stitches in design combination..... | 98 |
| Total Number of Stitches in Design Combination..... | 106 |
| Total number of stitches in embroidery combination..... | 122 |
| <i>Touch</i> | 24 |
| <i>Touch & Hold</i> | 24, 46 |
| <i>Touch and Move</i> | 24 |
| Touch Functions | 104 |
| Transparent Thread | 31 |
| Trim Position | 125 |
| Troubleshooting | 166 |
| Troubleshooting Connectivity | 169 |
| TrueType™ fonts..... | 54 |
| Turnable Hoop – Side Sort | 124 |
| Twin Needle..... | 94, 148 |

U

| | |
|--|---------|
| Undo | 98, 106 |
| Universal Needle..... | 32 |
| Unpacking Machine and Embroidery Unit..... | 26 |

| | |
|------------------------------------|---------|
| Unplug the cord..... | 27 |
| Unplug the foot control cord | 27 |
| USB device | 158–159 |
| USB Device | 160 |
| USB Port..... | 27 |
| User’s guide..... | 75 |
| Using a USB device | 27 |
| Utility Foot A | 17 |
| Utility Stitches | 19 |

V

| | |
|------------|----|
| Vinyl..... | 67 |
|------------|----|

W

| | |
|---------------------------------------|---------|
| Watch clip/full animation | 65 |
| Welcome to Embroidery Stitch Out..... | 123 |
| What is a Stitch?..... | 76 |
| WiFi | 47, 169 |
| WiFi Introduction | 52 |
| WiFi router | 169 |
| WiFi settings | 169 |
| WiFi Settings..... | 156 |
| Wing Needle | 32 |
| Wireless Firmware Update..... | 48 |
| Woven fabric..... | 67 |
| Woven Fabrics..... | 67 |
| Woven or Knit..... | 67 |

Y

| | |
|-----------------------------------|-----|
| Your Embroidery is Finished | 136 |
|-----------------------------------|-----|

Z

| | |
|---------------------|----------|
| Zipper Foot E | 17 |
| Zoom | 105, 124 |
| Zoom in..... | 105, 124 |
| Zoom options | 97, 122 |
| Zoom Options | 106, 125 |
| Zoom out..... | 105, 124 |
| zoom slider | 125 |
| Zoom slider | 97, 122 |
| Zoom to all..... | 106, 125 |
| zoom to cursor..... | 128 |
| Zoom to Cursor..... | 129 |
| Zoom to hoop..... | 106, 125 |

You have purchased a modern, updatable sewing and embroidery machine. As we regularly release firmware updates, it is possible that there may be some differences between the machine firmware and the firmware described in the user's guide. Consult your local authorized HUSQVARNA® VIKING® retailer, and be sure to visit our website at www.husqvarnaviking.com for the latest updates of the firmware and the user's guide.

We reserve the right to change the machine equipment and the assortment of accessories without prior notice, or make modifications to the performance or design. Such modifications, however, will always be to the benefit of the user and the product.

INTELLECTUAL PROPERTY

Patents protecting this product are listed on a label positioned underneath the Sewing Machine.

DELUXE, DESIGNER SAPPHIRE, EXCLUSIVE SENSOR SYSTEM, 173, JOYOS ADVISOR, MYSEWNET, VIKING, and KEEPING THE WORLD SEWING & Design are trademarks of KSIN Luxembourg II, S.a.r.l.
HUSQVARNA and the "crowned H-mark" are trademarks of Husqvarna AB and used under license.



Please note that on disposal, this product must be safely recycled in accordance with relevant National legislation relating to electrical/electronic products. Do not dispose of electrical appliances as unsorted municipal waste, use separate collection facilities. Contact your local government for information regarding the collection systems available. When replacing old appliances with new ones, the retailer may be legally obligated to take back your old appliance for disposal free of charge.

If electrical appliances are disposed of in landfills or dumps, hazardous substances can leak into the groundwater and get into the food chain, damaging your health and well-being.

Manufacturer

VSM GROUP AB, **SVP Worldwide**

Drottninggatan 2, SE-56184, Huskvarna, SWEDEN

