

# User's Guide

*Sapphire*™ 875 QUILT/855/835



This household sewing machine is designed to comply with IEC/EN 60335-2-28 and UL1594

# IMPORTANT SAFETY INSTRUCTIONS

When using an electrical appliance, basic safety precautions should always be followed, including the following:

Read all instructions before using this household sewing machine.

## **DANGER – To reduce the risk of electric shock:**

- A sewing machine should never be left unattended when plugged in. Always unplug this sewing machine from the electric outlet immediately after using and before cleaning.
- Always unplug before relamping. Replace bulb with same type rated 5 Watt.

## **WARNING – To reduce the risk of burns, fire, electric shock, or injury to person:**

- This sewing machine is not intended for use by persons (including children) with reduced physical, sensory or mental capabilities, or lack of experience and knowledge, unless they have been given supervision or instruction concerning use of the sewing machine by a person responsible for their safety.
- Children should be supervised to ensure that they do not play with the sewing machine.
- Use this sewing machine only for its intended use as described in this manual. Use only attachments recommended by the manufacturer as contained in this manual.
- Never operate this sewing machine if it has a damaged cord or plug, if it is not working properly, if it has been dropped or damaged, or dropped into water. Return the sewing machine to the nearest authorized dealer or service center for examination, repair, electrical or mechanical adjustment.
- Never operate the sewing machine with any air openings blocked. Keep ventilation openings of the sewing machine and foot controller free from the accumulation of lint, dust, and loose cloth.
- Keep fingers away from all moving parts. Special care is required around the sewing machine needle.
- Always use the proper needle plate. The wrong plate can cause the needle to break.
- Do not use bent needles.
- Do not pull or push fabric while stitching. It may deflect the needle causing it to break.
- Wear safety glasses.
- Switch the sewing machine off (“0”) when making any adjustment in the needle area, such as threading needle, changing needle, threading bobbin, or changing presser foot, etc.
- Always unplug sewing machine from the electrical outlet when removing covers, lubricating, or when making any other user servicing adjustments mentioned in the instruction manual.
- Never drop or insert any object into any opening.
- Do not use outdoors.
- Do not operate where aerosol (spray) products are being used or where oxygen is being administered.
- To disconnect, turn all controls to the off (“0”) position, then remove plug from outlet.
- Do not unplug by pulling on cord. To unplug, grasp the plug, not the cord.
- This sewing machine is provided with double insulation. Use only identical replacement parts. See instructions for Servicing of Double-Insulated Appliances.

## **SAVE THESE INSTRUCTIONS**

## **SERVICING OF DOUBLE INSULATED PRODUCTS**

In a double-insulated product, two systems of insulation are provided instead of grounding. No ground means is provided on a double-insulated product, nor should a means for grounding be added to the product. Servicing of a double-insulated product requires extreme care and knowledge of the system and should be done only by qualified service personnel. Replacement parts for a double-insulated product must be identical to those parts in the product. A double-insulated product is marked with the words ‘DOUBLE INSULATION’ or ‘DOUBLE INSULATED’.

## Getting ready to sew

Page 7-17

1

## Operating the machine

Page 18-34

2

## Basic sewing techniques

Page 35-46

3

## Taking care of the machine

Page 47-49

4

Machine overview and accessories, page 5-6

Stitch and alphabet overview, page 50-53

## Table of contents

Machine overview .....	5	Sewing Mode, 855/875 Quilt .....	23
Included accessories .....	6	Selecting a stitch .....	24
<b>1. Getting ready to sew</b>		Selecting a font .....	24
Unpacking .....	7	Programming .....	25
Packing away after sewing .....	7	My Stitches Menu .....	28
Accessory box .....	7	SET Menu .....	29
Extended Sewing Surface .....	7	Pop-up messages .....	31
Using the free arm .....	7	Exclusive SEWING ADVISOR™ .....	34
Connecting the foot control cord .....	8	<b>3. Basic sewing techniques</b>	
Connect the power cord and foot control .....	8	Seam .....	35
Lower the feed teeth .....	9	Edge/Quilting Guide (Only on 875 Quilt) .....	35
Changing the presser foot .....	9	Overcast .....	36
Changing the needle .....	9	Seam and overcast .....	37
Needles .....	10	Baste .....	38
Spool pins and spool caps .....	11	Darning and mending .....	38
Threading the upper thread .....	12	Blind hem .....	39
Needle threader .....	13	Hem .....	40
Cutting the thread .....	13	Sewing buttonholes .....	41
Threading for twin needles .....	14	Sewing on buttons .....	43
Winding the bobbin with the machine threaded ...	14	Sewing zippers .....	44
Winding the bobbin using the vertical spool pin ...	15	Free Motion Quilting .....	45
Winding the bobbin using the auxiliary spool pin ..	15	Decorative Tapering Stitches (Only on 875 Quilt) ..	46
Inserting the bobbin .....	16	<b>4. Taking care of the machine</b>	
Thread tension, 835/855 .....	16	Changing the light bulbs .....	47
Automatic thread tension, 875 Quilt .....	16	Cleaning the machine .....	47
EXCLUSIVE SENSOR SYSTEM™ (ESS) .....	17	Trouble shooting .....	48
Starting to sew .....	17	<b>2. Operating the machine</b>	
Function buttons .....	18	Stitch table - menu I. Utility stitches .....	50
Function buttons on the Touch Panel .....	20	Stitch overview .....	52
Sewing Mode, 835 .....	22	Alphabets .....	53



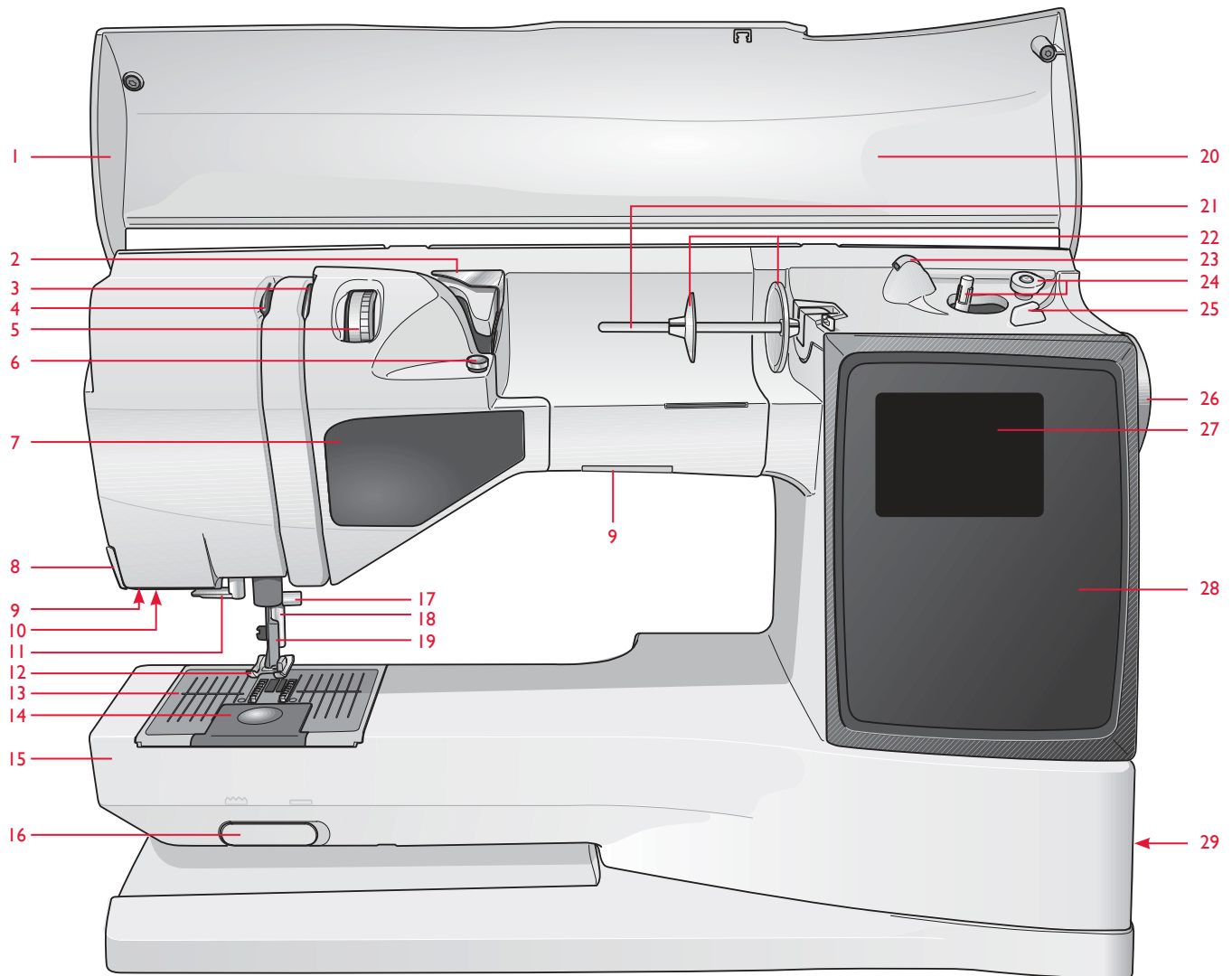





## Machine overview

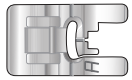

- |  |  |  |
|--|--|--|
| 1. Lid                                     | 12. Presser foot                       | 24. Bobbin spindle, Bobbin stop  |
| 2. Pre-tension thread guide                | 13. Stitch plate                       | 25. Thread cutter for bobbin thread  |
| 3. Thread tension disks                    | 14. Bobbin cover                       | 26. Handwheel  |
| 4. Thread take-up lever                    | 15. Free arm                           | 27. GraphicDisplay, 855/875 Quilt. (The GraphicDisplay on 835 is a different size) |
| 5. Thread tension dial, 835/855            | 16. Drop feed teeth switch             | 28. Touch Panel with function buttons  |
| 6. Thread tension for bobbin winding       | 17. Needle bar with needle clamp screw | 29. ON/OFF switch, connectors for power cord and foot control                      |
| 7. Function button panel                   | 18. Presser bar                        |  |
| 8. Thread cutter                           | 19. Presser foot ankle                 |  |
| 9. Light bulbs                             | 20. Stitch panel                       |  |
| 10. Sensor One-Step Buttonhole Foot socket | 21. Spool pin                          |  |
| 11. Needle threader                        | 22. Spool caps                         |  |
|  | 23. Auxiliary spool pin                |  |

## Included accessories

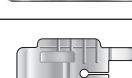
### Presser Feet

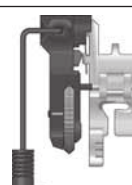
	<b>Utility Foot A</b>	Attached on the machine upon delivery. This foot is used mainly for straight stitching and zigzag stitching with a stitch length longer than 1.0.
	<b>Utility Foot B</b>	When sewing decorative stitches or short zigzag stitches and other utility stitches with less than 1.0 mm stitch length, use this foot. The tunnel on the underside of the foot is designed to feed smoothly over the stitches.
	<b>Buttonhole Foot C</b>	This foot is used for sewing buttonholes step by step. Use the guide lines on the toe of the foot to position the garment edge. The two tunnels on the bottom of the foot ensures a smooth feed over the buttonhole columns. The finger on the back of the foot holds cording for corded buttonhole.
	<b>Blind Hem Foot D</b>	This foot is used for blind hem stitches. The inner edge of this foot guides the fabric. The right toe of the foot is designed to ride along the hem edge.
	<b>Zipper Foot E</b>	This foot can be snapped on either to the right or to the left of the needle, making it easy to sew close to both sides of the zipper teeth. Move needle position to right or left to sew closer to zipper teeth or for covering large cording.
	<b>Non-Stick Glide Foot H</b>	This foot, with a non-stick coating underneath, is used when sewing foam, vinyl, plastic, or leather to minimize the risk of these materials sticking to the foot.
	<b>Edging Foot J</b>	This foot is used for overcasting and seam/overcasting. Stitches form over the pin which prevents puckering at the edge of the fabric.
	<b>Quilter's 1/4" Piecing Foot P</b> (Only with 875 Quilt)*	This foot is used when piecing quilt blocks. The foot has seam guide marks 1/4" (6 mm) and 1/8" (3 mm). The foot can only be used with straight stitch.
	<b>Clear Open Toe Foot</b> (Only with 875 Quilt)*	For satin stitch applique, taper stitches and decorative stitches. The tunnel on the underside of the foot feeds smoothly over the stitches and the transparent foot with open front gives greater visibility for accuracy.
	<b>Embroidery/ Darning Foot R</b>	For free-motion darning, quilting and embroidery.
	<b>Sensor One-Step Buttonhole Foot</b>	When connected to the machine, the buttonhole is sewn in a suitable length to the button size that has been entered into the machine.

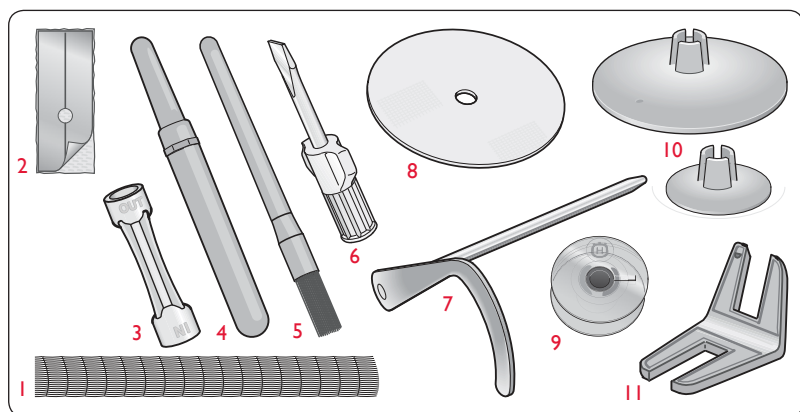

1. Thread nets. Slide on the spool when using synthetic threads that easily unwind (2).
2. Non-Stick glide plates (2)
3. Light bulb remover
4. Seam ripper
5. Brush
6. Screwdriver
7. Edge/quilting guide (Only with 875 Quilt).
8. Felt pad (2)
9. Bobbins (5)
10. Extra spool caps, one large, one small.
11. Multipurpose tool/button reed

Needles (not pictured)

\*Sold separately for 835 and 855

## Unpacking

1. Place the machine on a sturdy, flat surface, remove the packaging and lift off the cover.
2. Remove the packing material and the foot control.
3. The machine is delivered with an accessory bag, a power cord and a foot control cord.
4. Wipe the machine, particularly around the needle and stitch plate to remove any soil before sewing.

## Packing away after sewing

1. Press the ON/OFF switch to OFF.
2. Unplug the cord from the wall socket and then from the machine.
3. Unplug the foot control cord from the machine. Wind the foot control cord inside the space on the underside of the foot control.
4. Check to ensure that all accessories are in the accessory box. Slide the box on to the machine, behind the free arm.
5. Place the foot control in the space above the free arm.
6. Put on the cover.

## Accessory box

There are special places for presser feet and bobbins in the accessory box, plus space for needles and other accessories. Store the accessories in the box so they are easily accessible.

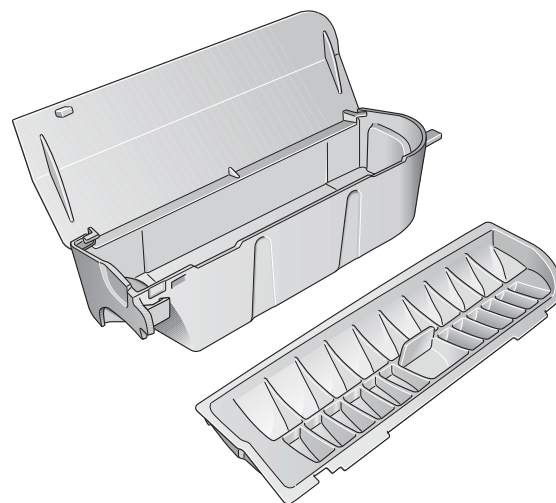

## Extended Sewing Surface

The space at the right side of the needle, between the needle and the arm, gives you a great deal of extra space. This makes sewing large projects and quilts much easier than on other sewing machines. Keep the accessory box on the machine to provide a large, flat work surface.

## Using the free arm

Slide the accessory box to the left when you wish to remove it and use the free arm.

Use the free arm to facilitate sewing trouser legs and sleeve hems.

To replace the accessory box, slide it onto the machine until it fits in place.

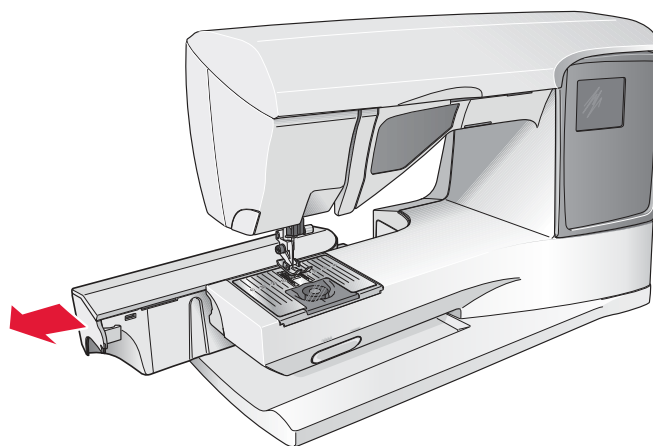

## Connecting the foot control cord

Among the accessories you will find the foot control cord and the power cord. Connecting the foot control cord to the foot control is only necessary the very first time you are going to use the machine.

1. Take out the foot control cord. Turn the foot control over. Connect the cord to the socket inside the space of the foot control.
2. Push firmly to make sure it is properly connected.
3. Lay the cord in the slot on the underside of the foot control.

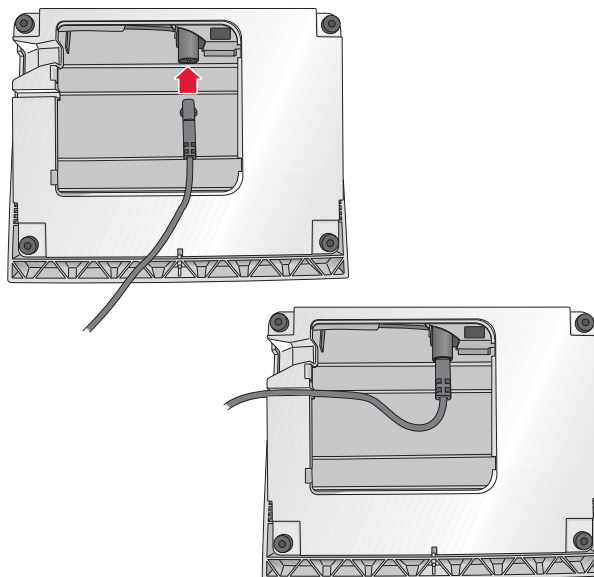

## Connect the power cord and foot control

On the underside of the machine you will find information about the power supply voltage (V) and the frequency (Hz).

*Before plugging in the foot control, check to ensure that it is of type "FR5" (see underside of foot control).*

1. Connect the foot control cord to the front socket on the bottom right side of the machine.
2. Connect the power cord to the rear socket on the bottom right side of the machine.
3. Press the ON/OFF switch to ON to turn on power and light.



### For the USA and Canada

This sewing machine has a polarized plug (one blade wider than the other). To reduce the risk of electric shock, this plug is intended to fit in a polarized outlet only one way. If the plug does not fit fully in the outlet, reverse the plug. If it still does not fit, contact a qualified electrician to install the proper outlet. Do not modify the plug in any way.

## Lower the feed teeth

The feed teeth are lowered when you move the switch on the front of the free arm to the right. Move the switch to the left if you wish to raise the feed teeth. The feed teeth will raise as you begin to sew. The feed teeth should be lowered when sewing on buttons and for free motion sewing.

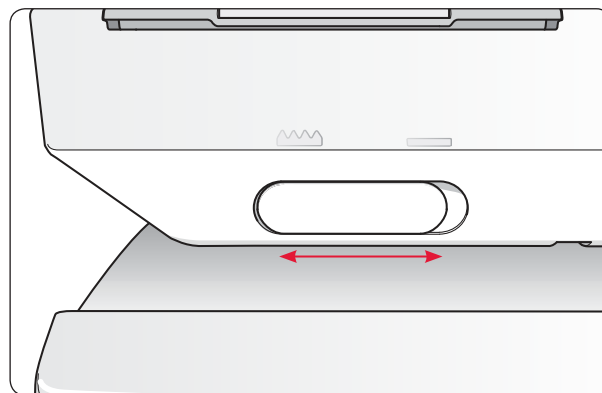

## Changing the presser foot

 Press the ON/OFF switch to OFF.

1. Make sure the needle is in the highest position and the presser foot is lifted. Pull the presser foot towards you.
2. Line up the cross pin on the foot with the gap in the presser foot ankle. Push back until the foot snaps into place.

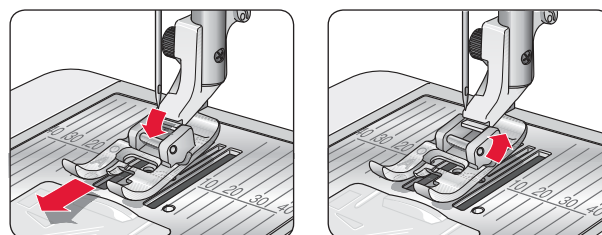

## Changing the needle

 Press the ON/OFF switch to OFF.

1. Use the hole in the multipurpose tool to hold the needle.
2. Loosen the screw in the needle clamp with the screwdriver.
3. Remove the needle.
4. Insert the new needle using the multipurpose tool. With the flat side away from you, push the new needle upwards until it will go no further.
5. Use the screwdriver to tighten the screw.

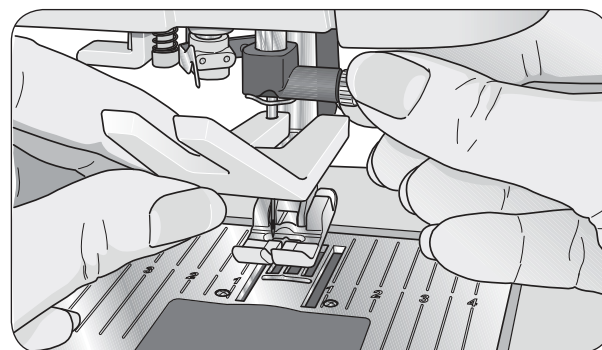

## Needles

The sewing machine needle plays an important role in successful sewing. To ensure you will get a quality needle, we recommend needles of system 130/705H. The needle package included with your machine contains needles of the most frequently used sizes for sewing on woven and stretch fabrics.

### Universal needle (A)

Universal needles have a slightly rounded point and come in a variety of sizes. For general sewing in a variety of fabric types and weights.

### Stretch needle (B)

Stretch needles have a special scarf to eliminate skipped stitches when there is a flex in the fabric. For knits, swimwear, fleece, synthetic suedes and leathers. Marked with a yellow band.

### Denim needle (C)

Denim needles have a sharp point to penetrate tightly woven fabrics without deflecting the needle. For canvas, denim, microfibers. Marked with a blue band.

### Wing needle (D)

The Wing needle has wide wings on the side of the needle to poke holes in the fabric when sewing entredeux and other hemstitches on natural fiber fabrics.

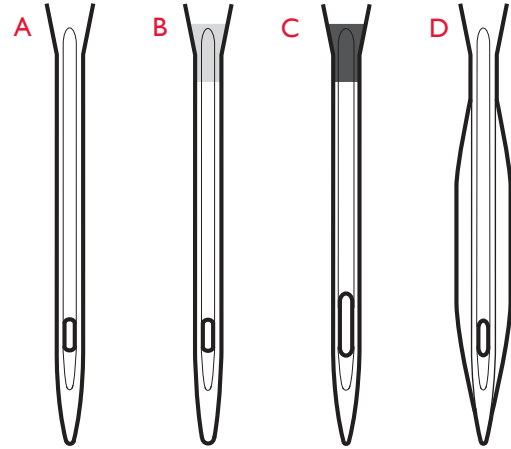

**NOTE:** Change the needle often. Always use a straight needle with a sharp point (1). A damaged needle (2) can cause skipped stitches, breakage of needles or snapping of thread. A damaged needle can also damage the stitch plate.

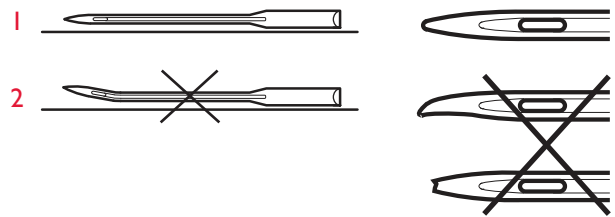

## Spool pins and spool caps

Your sewing machine has two spool pins, a main spool pin and an auxiliary spool pin. The spool pins are designed for all types of thread. The main spool pin is adjustable and can be used in a horizontal position (the thread reels off the stationary spool) or in a vertical position (the thread spool rotates). Use the horizontal position for all regular sewing threads and the vertical position for large spools or specialty threads.

### Horizontal Position

Lift the spool pin up slightly from its horizontal position to easily place the thread spool on the pin. The thread should reel over the top, in a counterclockwise direction, as shown in the picture. Slide on a spool cap and then move the spool pin back to the horizontal position.

Each machine comes with two spool caps on the spool pin. For medium sized thread spools, the medium sized cap (A) is placed in front of the spool. For large thread spools, the large cap (B) is placed in front of the spool.

The flat side of the spool cap should be pressed firmly against the spool. There should be no space between spool cap and thread spool.

Two extra spool caps, one small and one large, are also included as accessories for your machine. The small spool cap can be used for small thread spools. The second large spool cap can be used when winding a bobbin from a second spool of thread or when sewing with a twin needle.

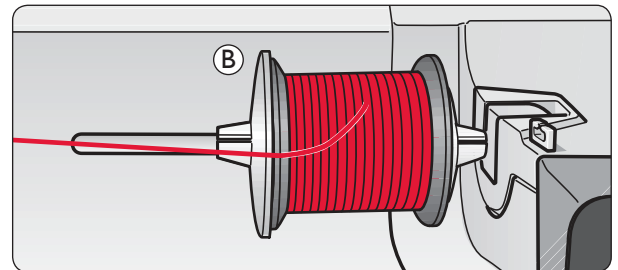
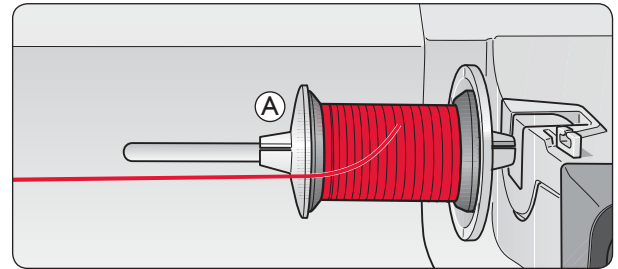

### Vertical Position

Lift the spool pin up and all the way to the right. Lock the spool pin in the vertical position by slightly pressing it down. Slide on the large spool cap. For spools smaller than the medium size spool cap or when using specialty threads, place a felt pad under the thread spool to prevent the thread from reeling off too fast. For larger spools, the felt pad is not needed.

**NOTE:** No spool cap should be placed on top of the spool as this prevents the spool from rotating.

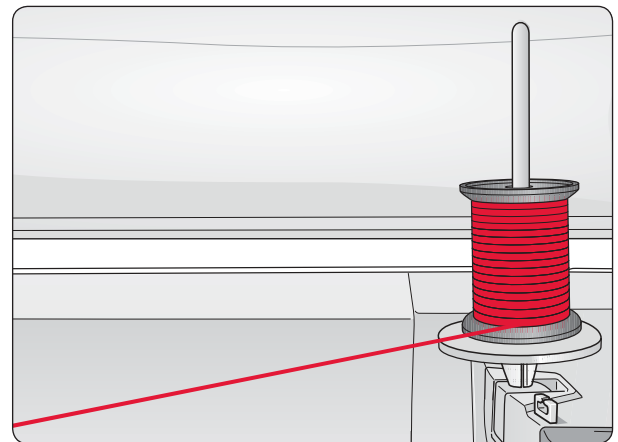

### Auxiliary Spool Pin

The auxiliary spool pin is used when winding a bobbin from a second spool of thread or for a second spool when sewing with a twin needle.

Lift the auxiliary spool pin up and to the left. Slide on the large spool cap. For spools smaller than the medium size spool cap, place a felt pad under the thread spool to prevent the thread from reeling off too fast. For larger spools, the felt pad shall not be used.

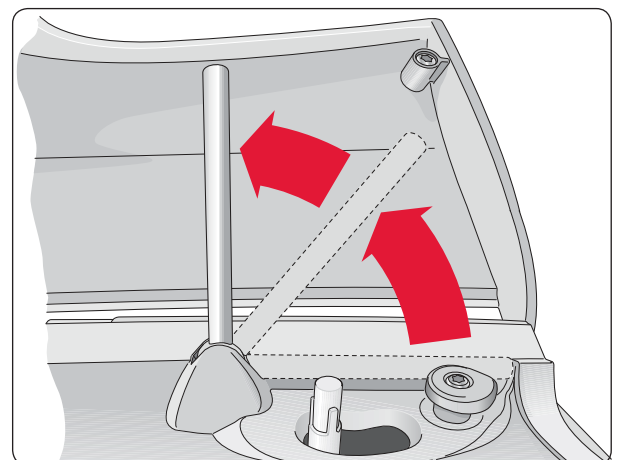

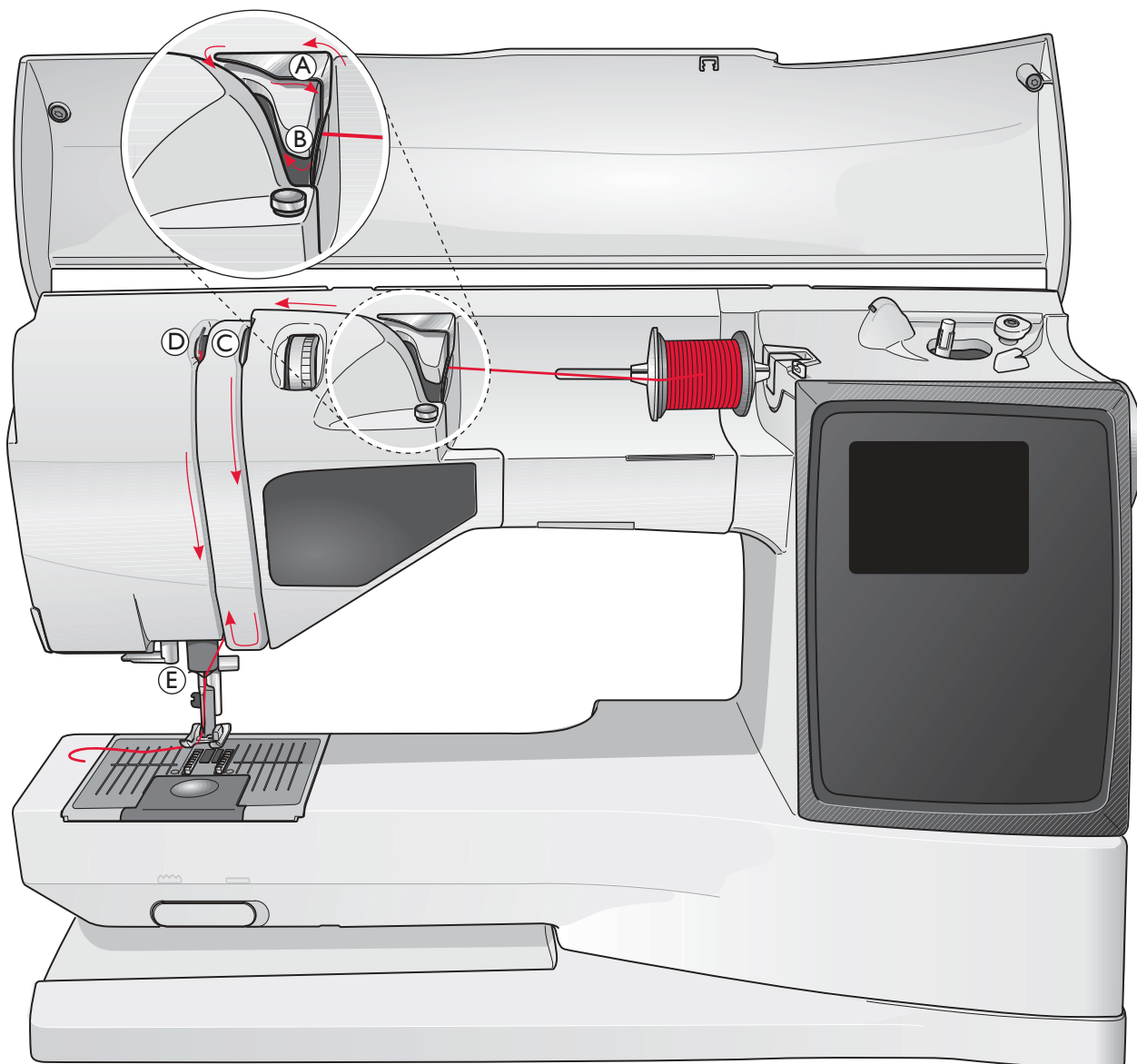

## Threading the upper thread



Make sure the presser foot is raised and the needle is in the up position



*Press the ON/OFF switch to OFF.*

1. Place the thread on the spool pin and the spool cap on the spool pin as described on page 11.
2. **Spool pin in horizontal position:**  
Bring the thread over and behind the pre-tension thread guide (A) and under the thread guide (B).
- Spool pin in vertical position:**  
Instead of bringing the thread into the pre-tension guide (A), bring it directly under the thread guide (B).
3. Bring the thread down between the thread tension discs (C).
4. Continue threading in the direction indicated by the arrows. Bring the thread from the right into the slot on the take-up lever (D).
5. Take the thread down and behind the last guide just above the needle (E).

## Needle threader



The needle must be in the up position to use the built-in needle threader. We also recommend lowering the presser foot.

1. Use the handle to pull the needle threader all the way down, catching the thread under the guide (A).
2. Push back to bring the needle threader forward until the metal flanges cover the needle. A small hook will pass through the needle eye (B).
3. Place the thread under the flanges in front of the needle, so the thread catches into the small hook (C).
4. Let the needle threader gently swing back. The hook pulls the thread through the needle eye and forms a loop behind the needle. Pull the thread loop out behind the needle.
5. Place the thread under the presser foot.

**NOTE:** The needle threader is designed to be used for size 70-120 needles. You cannot use the needle threader for size 60 needles or smaller, the wing needle, twin needle, triple needle or when the Sensor One-Step Buttonhole Foot is on. There are also some other optional accessories that require manual threading of the needle.

When threading the needle manually, make sure that the needle is threaded from front to back. The white presser foot ankle makes it easy to see the eye of the needle. The bobbin case cover can be used as a magnifying glass.

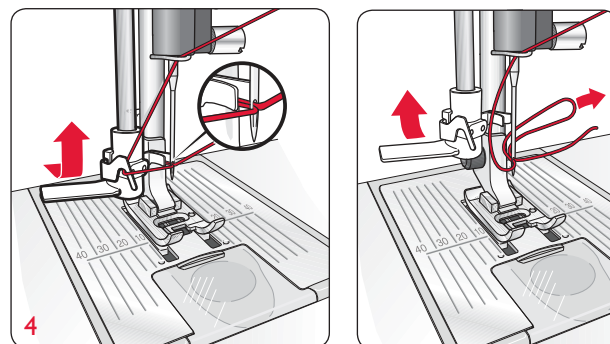
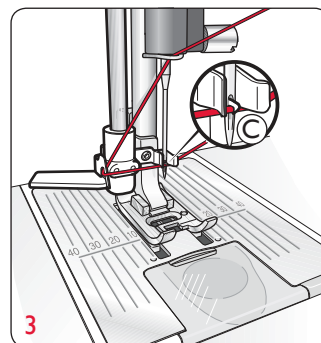
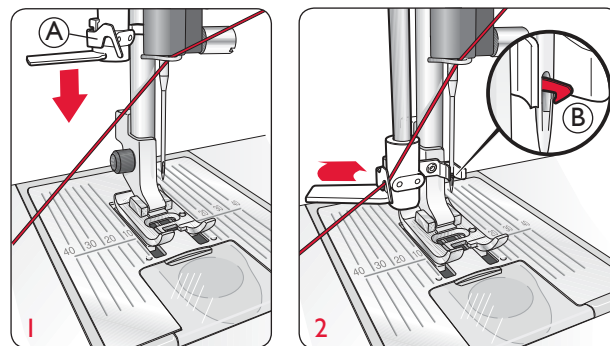

## Cutting the thread

Once you have finished sewing, cut the threads by raising the presser foot and pulling the threads from the back to the front into the thread cutter on the left side of the machine.

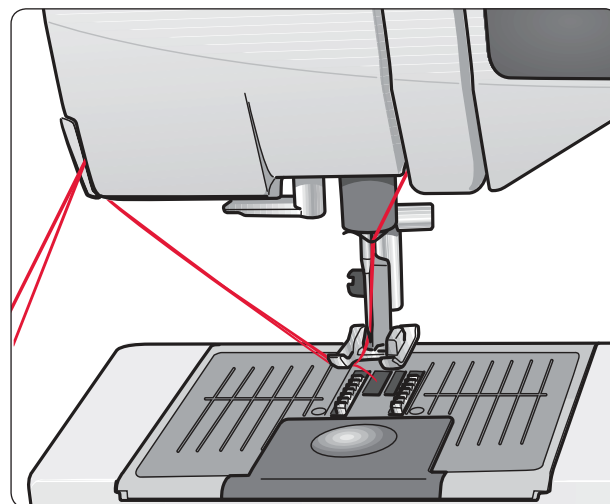

## Threading for twin needles

 Press the ON/OFF switch to OFF.

1. Insert a twin needle.
2. Use a second thread spool or wind a bobbin with the thread you are going to use as the second upper thread.
3. Lift the spool pin up and all the way to the right. Lock the spool pin in the vertical position by slightly pressing it down. Slide on the large spool cap. For spools smaller than the medium size spool cap, place a felt pad under the thread spool.
4. Place the first thread spool on the spool pin. The spool should rotate in a clockwise direction when the thread reels off the spool.
5. **LEFT NEEDLE:** Thread the machine as described on page 13. Check to ensure that the thread lies between the left thread tension discs (A). Thread the left needle manually.
6. Pull out the auxiliary spool pin and slide on the large spool cap. For spools smaller than the medium size spool cap, place a felt pad under the thread spool.
7. Place the second thread on the spool pin. The second spool should rotate in a counterclockwise direction when the thread reels off the spool.
8. **RIGHT NEEDLE:** Thread the machine as before but this thread should lie between the right thread tension discs (A) and outside the needle thread guide (B). Thread the right needle manually.

**NOTE:** Only use symmetrical twin needles (C). Do not use this type of twin needle (D), since it may damage your sewing machine.

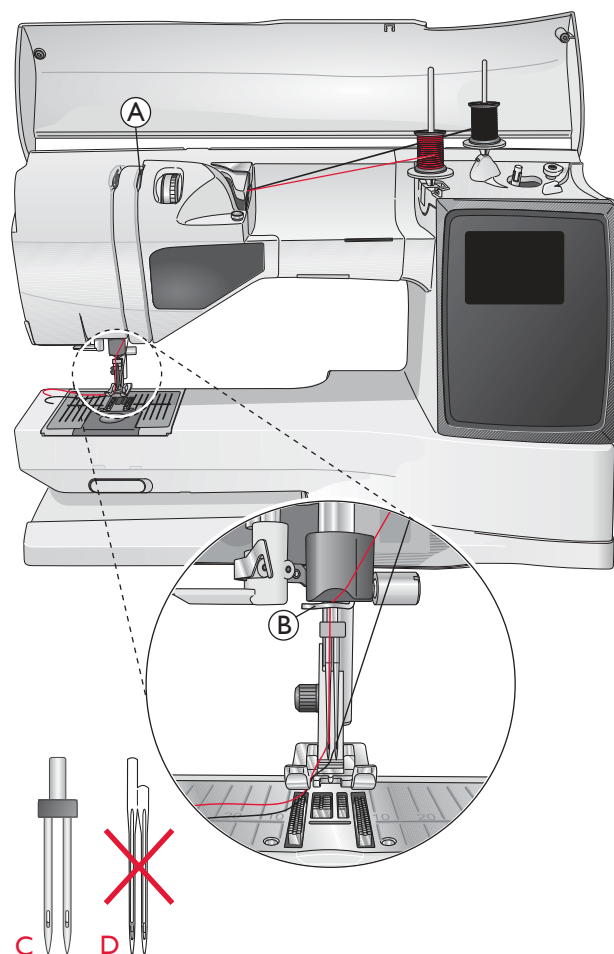

## Winding the bobbin with the machine threaded



Make sure that the presser foot is up and the needle is in the highest position.

*Note! Do not use a plastic presser foot when bobbin winding.*

1. Place an empty bobbin on the bobbin spindle on the top of the machine. The bobbin only fits on one way, with the logo facing up. Use only original HUSQVARNA VIKING® bobbins.
2. Pull the thread from the needle under the presser foot and to the right through the thread guide (C).
3. Guide the thread through the hole in the bobbin (D) from the inside to the outside.

**NOTE:** When using an earlier version of HUSQVARNA VIKING® bobbins that do not have a hole, wind several turns of thread on the bobbin to get started.

4. Push the bobbin spindle to the right. A pop-up message appears on the GraphicDisplay. Press the foot control to start winding. Hold the end of the thread firmly when starting to wind. Once the bobbin begins to wind, cut the excess thread. When the bobbin is full, it will stop automatically. Push the bobbin spindle back to the left, remove the bobbin and cut off the thread on the thread cutter.

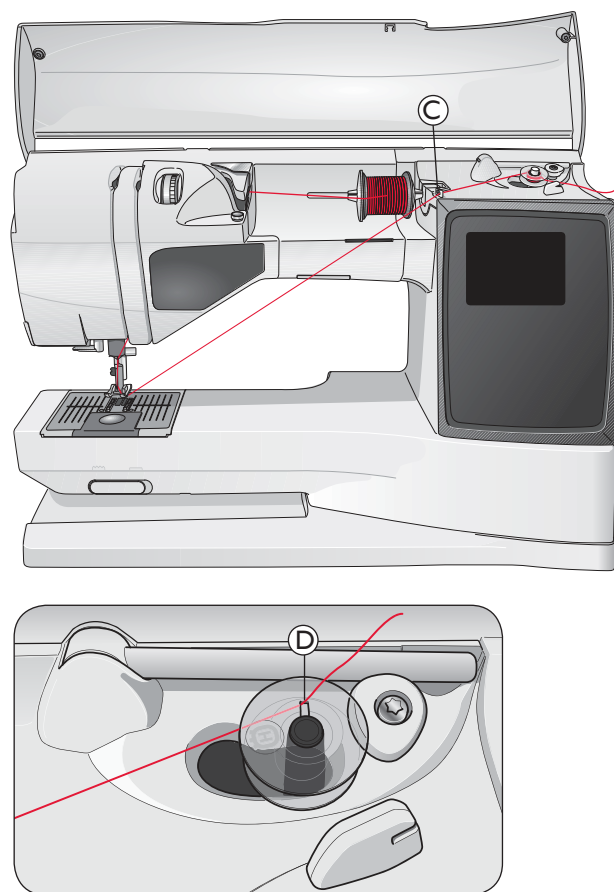

## Winding the bobbin using the vertical spool pin

1. Place an empty bobbin on the bobbin spindle on the top of the machine. The bobbin only fits on one way, with the logo facing up. Use only original HUSQVARNA VIKING® bobbins.
2. Place the large spool holder and a felt pad under the spool on the main spool pin set in the vertical position.
3. Bring the thread over and behind the pre-tension thread guide (A) and down around the thread tension disc (B), then through thread guide (C) as illustrated.
4. Guide the thread through the hole in the bobbin (D) from the inside to the outside.
5. Push the bobbin spindle to the right. A pop-up message appears on the GraphicDisplay. Press the foot control to start winding. Hold the end of the thread firmly when starting to wind. Once the bobbin begins to wind, cut the excess thread. When the bobbin is full, it will stop automatically. Push the bobbin spindle back to the left, remove the bobbin and cut off the thread on the thread cutter.

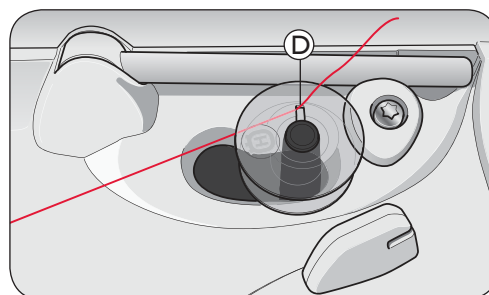
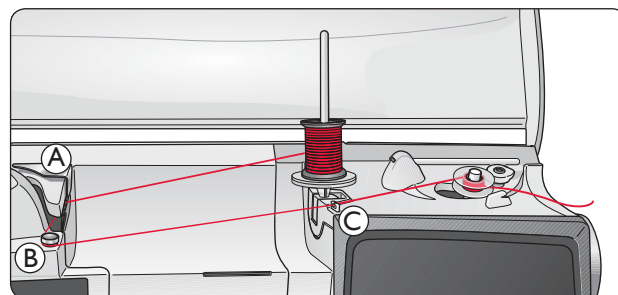

**NOTE:** When using an earlier version of HUSQVARNA VIKING® bobbins that do not have a hole, wind several turns of thread on the bobbin to get started.

## Winding the bobbin using the auxiliary spool pin

1. Place an empty bobbin on the bobbin spindle on the top of the machine. The bobbin only fits on one way, with the logo facing up. Use only original HUSQVARNA VIKING® bobbins.
2. Fold out the auxiliary spool pin. Place a large spool holder and a felt pad under the spool.
3. Bring the thread over and behind the pre-tension thread guide (A) and down around the thread tension disc (B), then through thread guide (C) as illustrated.
4. Guide the thread through the hole in the bobbin (D) from the inside to the outside.
5. Push the bobbin spindle to the right. A pop-up message appears on the GraphicDisplay. Press the foot control to start winding. Hold the end of the thread firmly when starting to wind. Once the bobbin begins to wind, cut the excess thread. When the bobbin is full, it will stop automatically. Push the bobbin spindle back to the left, remove the bobbin and cut off the thread on the thread cutter.

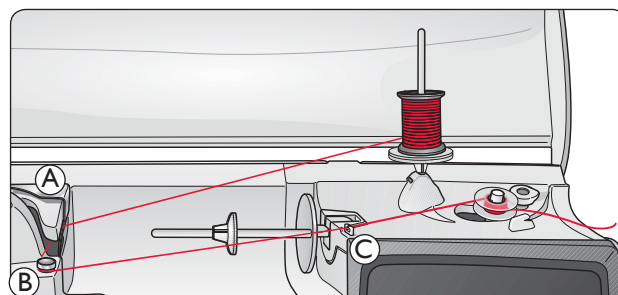

**NOTE:** Depending on the type of thread, wrap the thread one or two turns around the bobbin thread tension disc (B) to put more tension on the thread.

## Inserting the bobbin

 Press the ON/OFF switch to OFF.

1. Remove the bobbin cover by sliding it towards you.
2. Place the bobbin in the bobbin case. It drops in only one way with the logo facing up. The thread unreels from the left of the bobbin. The bobbin will then rotate counter-clockwise when you pull the thread.
3. Place your finger on the bobbin to keep it from turning as you pull the thread firmly to the right and then to the left into the tension spring (E) until it “clicks” into place.
4. Continue threading around (F) and to the right of the thread cutter (G). Slide on the bobbin cover (H). Pull the thread to the left to cut (I).

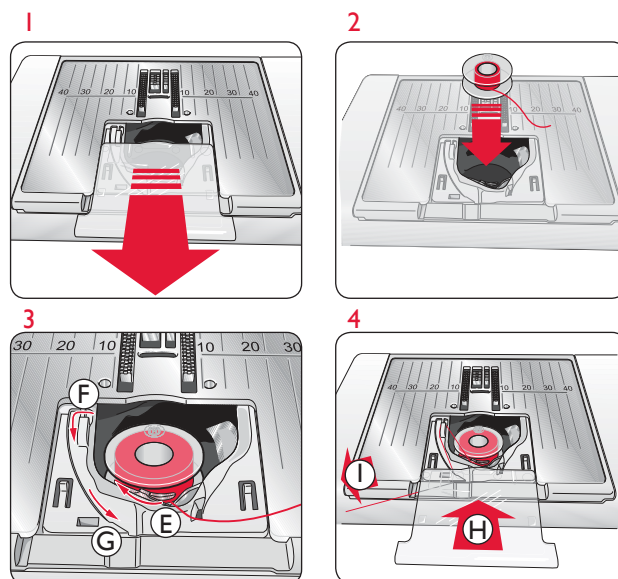

## Thread tension, 835/855

Use the recommended top thread tension setting given on the GraphicDisplay. You might need to adjust the top thread tension for special threads, fabrics and/or techniques. To set the tension, turn the numbered tension dial. The higher the number the tighter the tension.

Normally top thread tension is set to around 4. When sewing buttonholes and decorative stitches set thread tension to around 3. When topstitching with a heavy thread in thick fabric, increase the tension to 7-9.

Make a few tests on a scrap piece of the fabric you are going to sew and check the tension.

### Correct and incorrect thread tension

To understand the correct thread tension, sew a few sample straight stitches at different settings.

1. Begin with a tension that is too loose, i.e. set at the lowest number. The bobbin thread will lie straight and the top thread will be drawn to the underside of the fabric.
2. If you set the tension at the highest number, the bobbin thread will be visible on the top side of the fabric. The seam may pucker and the top thread might break.
3. The correct thread tension is set when the threads interlock in between both fabric layers or, in the case of decorative stitches, on the underside.

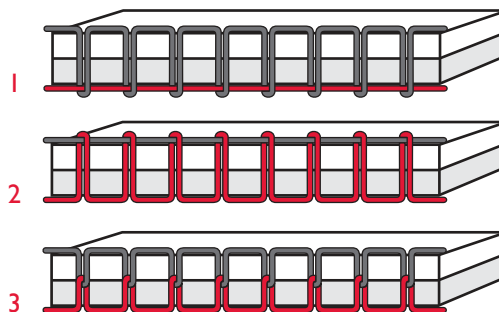
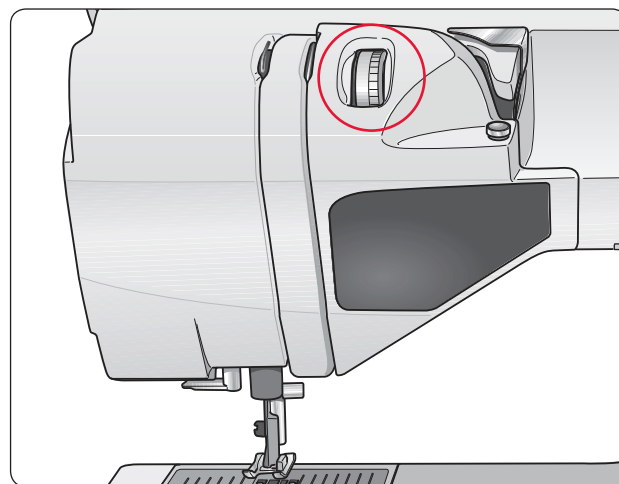

## Automatic thread tension, 875 Quilt

The 875 Quilt model automatically sets the best thread tension for the selected stitch and fabric. Go to the SET Menu to adjust the thread tension for specialty thread, techniques or fabric (see page 29).

## EXCLUSIVE SENSOR SYSTEM™ (ESS)

### Sensor Foot Pressure

With the Sensor Foot Pressure, the presser foot actually senses the thickness of fabric and stitching to sew over it smoothly and evenly with perfect fabric feeding.

If you want to see the actual setting of the presser foot pressure for the selected fabric and adjust the pressure manually, go to the SET Menu (see page 29).

### Sensor Foot Lift



The presser foot on your sewing machine is raised and lowered in four levels with the Sensor Foot Up and Down buttons (see next page).

The presser foot is automatically lowered when you start sewing. When you stop with the needle in the down position, the presser foot automatically senses the thickness of the fabric and raises the presser foot to just the right height to float over the fabric for pivoting. Go to the SET Menu to turn off this function (see page 29).

## Starting to sew

The buttons at the bottom of the Touch Panel are the Exclusive SEWING ADVISOR™ buttons that will help you to get the best stitch and settings when you are sewing.

Press the button for the type and weight of fabric you are using and press the button for the desired sewing technique or select a stitch from one of the menus (see page 34).

Place top and bobbin thread under the presser foot and to the back. For best results when beginning at the edge of the fabric, place a finger on the threads to hold them in place as you begin.

Place fabric in position under the presser foot.

Step on the foot control to begin sewing. The presser foot is lowered automatically.

Guide the fabric gently with your hands as the machine is feeding.

## Function buttons

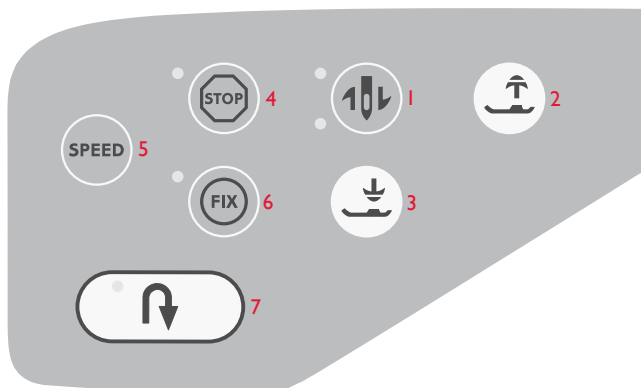

835/855

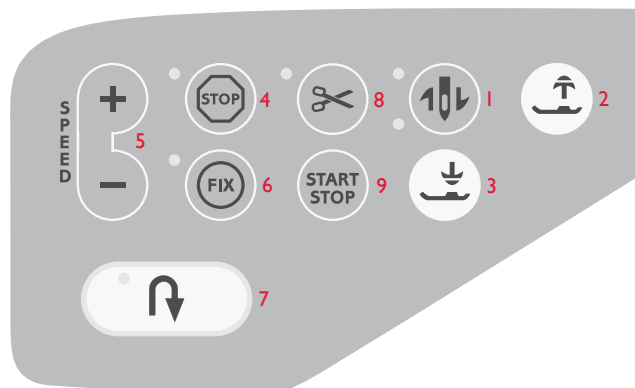

875 Quilt

### 1. Needle Stop Up/Down

Press this button to move the needle down or up. The setting of the needle stop position is changed at the same time.

The upper LED next to the button is lit when needle up is activated and the lower LED is lit when needle down is activated.

You can also tap the foot control to raise or lower needle. If both the needle and the presser foot are in up position, only the presser foot will be lowered when you tap the foot control the first time. Tap again to lower the needle.

### 2. Sensor Foot Up/Extra Lift

This button raises the presser foot to the up position. Press the button once more and the presser foot will raise to the Extra Lift position, to make it easy to place and remove heavy or fluffy fabrics and battings under the presser foot.

### 3. Sensor Foot Down/Pivot Position

Press Sensor Foot Down and Pivot and the presser foot will be completely lowered so the machine firmly holds the fabric. Press Sensor Foot Down again to raise the presser foot to Pivot position or a floating position over the fabric for easier placement of the fabric.

The presser foot will be lowered automatically when you start sewing. You can also tap the foot control to lower the presser foot.

When you stop with the needle in the down position, the presser foot is automatically lifted to pivot position. This function can be turned off in the SET Menu, see page 29.

### 4. Stop

STOP is used to conclude a stitch or to sew just one unit of the stitch. Your sewing machine ties off the thread and stops automatically when one stitch unit or stitch program has been completed. The LED next to the button is lit when STOP is activated. STOP is cancelled once you have used the function. Press the button again if you wish to activate it once more.

STOP is also used to repeat the same size darning, bartack and Automatic Tapering stitch with the same size.

**TIP:** If you want to repeat the STOP function for a stitch unit several times in a row you can save the stitch with a STOP at the end in a program (see Programming, page 25).

### 5. Speed

All stitches in your sewing machine have a pre-set, recommended sewing speed. Press the SPEED button or, on the 875 Quilt model: SPEED+ or SPEED- to increase or decrease the sewing speed. For 835 and 855 there are three speed levels and for 875 Quilt there are five speed levels. The speed level is shown on the GraphicDisplay. You cannot select a higher speed than the default max speed for the selected stitch.

**6. Fix**

By using the FIX button you can lock the stitch at the beginning and/or at the end. The LED next to the button is lit when FIX is activated. Press the FIX button to turn off the function.

The FIX function is automatically activated when a stitch is selected or when STOP, the Selective Thread Cutter\* or Stitch Restart\* has been used. You can turn off the automatic FIX function in the SET Menu, see page 29.

The FIX function can be programmed (see page 26).

**7. Reverse**

Press the button while sewing and the machine will sew in reverse until the button is released. Then your sewing machine will sew forward. The LED on the button is lit when reverse is activated.

For permanent reverse, press the button once before starting to sew. Your sewing machine sews in reverse until you press the button again.

Reverse is also used when sewing buttonholes, bartacks, darning and to begin and end tapering stitches\* to step between the parts of the stitch.

**8. Selective Thread Cutter (Only on 875 Quilt)**

Press the Selective Thread Cutter button and your machine ties off the threads, cuts the top and bottom threads, raises the presser foot and the needle, and activates the FIX function for the next start. To cut threads at the end of a stitch or stitch program, press Selective Thread Cutter while sewing. The LED next to the button starts flashing indicating that a cut is requested. When the stitch or stitch program is completed, the upper thread and bobbin will be cut.

The Selective Thread Cutter function can be programmed (see page 26).

**NOTE:** After a buttonhole or an eyelet is sewn, your machine cuts automatically. Automatic Selective Thread Cutter can be cancelled in the SET Menu, see page 29.

**9. Start/Stop (Only on 875 Quilt)**

Press this button to run and stop the machine without the foot control. Press the button once to begin sewing and press again to stop sewing.

## Function buttons on the Touch Panel

### ALT 10. Alternate View

When you select a satin stitch the length and width settings will be shown on the GraphicDisplay. By pressing the Alternate View button the density setting will be shown instead of the length setting.

On the 875 Quilt model the stitch position settings will be shown instead of the stitch width when you press the Alternate View button.

### - + 11. Stitch Length/Density

When you select a stitch, your machine automatically sets the best stitch length. The stitch length is visible on the GraphicDisplay. You can change the stitch length by pressing the + or – button.

If you have selected a buttonhole the GraphicDisplay will show the density setting instead of the stitch length setting. You will now be able to change the density setting by pressing the + and – buttons.

If you press the Alternate View button the GraphicDisplay will show the density setting for satin stitches. Use the + and – buttons to change the setting.

### - + 12. Stitch Width/Needle position

The stitch width is set in the same manner as the stitch length. The preset width is visible on the GraphicDisplay. The width can be adjusted between 0 and 7 mm. Some stitches have a limited stitch width.

If a straight stitch is selected, the + and – buttons are used to move the needle to the left or right in 29 positions.

### 875 Quilt: Stitch Positioning

The Stitch Positioning function in the 875 Quilt model makes it possible to change the needle position of all stitches. Press the Alternate View button and the GraphicDisplay will show the needle position instead of the stitch width settings. You will now be able to change the needle position to the left or right by pressing the + and – buttons. The needle position can only be changed to the limit of the maximum stitch width. Changing the needle position will also limit the stitch width adjustment.

### CLR 13. Clear

Press this button to delete a single stitch or all stitches in a stitch program. Or use it to delete your saved stitches and stitch programs in the My Stitches Menu. This button is also used to activate tapering for Decorative Tapering Stitches.

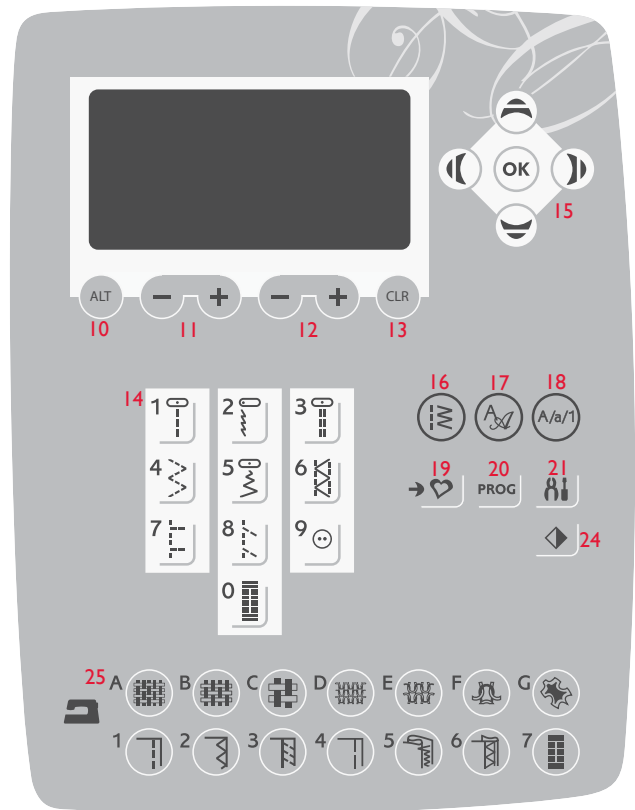

835

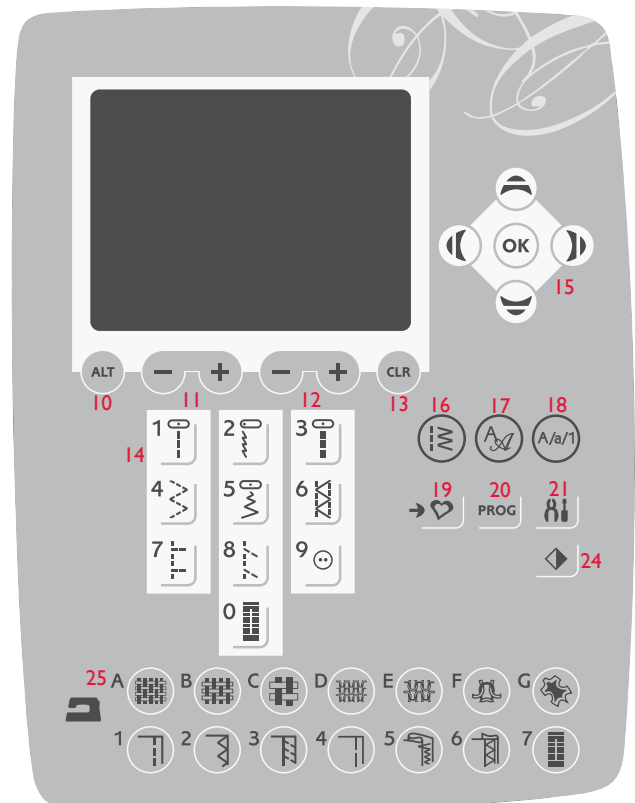

855

## 14. Stitch Selection Buttons

By pressing any of the 0 to 9 buttons you select the stitch illustrated on that button immediately.

By pressing two digits in quick succession you will be able to select a stitch from 10 and up from the selected stitch menu. If the stitch number does not exist in the selected stitch menu you will hear a beep and the first entered digit will be selected as a stitch.

## 15. Navigator Arrow Buttons

Make your selections with the arrow buttons and confirm your selections or changes with the OK button.

Use the left/right arrow buttons to select stitches step by step in numerical order within the selected stitch menu.

The arrow buttons are also used when programming to select stitches within the program or to select letters to insert in the program.

The up and down arrow buttons are also used to set the size of a buttonhole and to set the number of stitches when sewing on a button.



875 Quilt

## 16. Stitch Menu

Press this button to select a stitch from any of the stitch menus shown on the GraphicDisplay.

## 17. Font Menu

Press this button to open the Font Menu on the GraphicDisplay to select a font.

## A/a/1 18. Shift to upper-case, lower-case or numbers

Press this button to shift to lower or upper-case or numbers when programming letters.

## →♥ 19. Save to My Stitches

This button opens the menu where you can save your own personal stitches or stitch programs. Press the button again to exit the My Stitches mode.

## PROG 20. Program Mode

Press this button to open the mode for programming. Press the button again to exit the program mode.

## 8 21. SET Menu

Press this button to open the menu for machine settings. Make changes and selections by using the arrow buttons (15). Press the button again to exit the SET Menu.

## → 22. Stitch Re-start (Only on 875 Quilt)

If you have stopped sewing in the middle of a stitch, touch Re-start to start sewing at the beginning of the stitch again without having to re-set any special settings you have made.

## ◀ 23. Mirror End to End (Only on 875 Quilt)

Press this button to mirror the selected stitch end to end. If the button is pressed in Sew Out Mode for stitch programs, the whole stitch program is mirrored. The change is visible on the GraphicDisplay.

## ◀ 24. Mirror Side to Side

Press this button to mirror the selected stitch side to side. If the button is pressed when straight stitch with left needle position is selected, the needle position is changed from left to right. If the button is pressed in Sew Out Mode for stitch programs, the whole stitch program is mirrored. The change is visible on the GraphicDisplay.

## 25. Exclusive SEWING ADVISOR™

The Exclusive SEWING ADVISOR™ feature sets the best stitch, stitch length, stitch width, sewing speed, thread tension\* and Sensor Foot Pressure for the selected fabric and sewing technique. The stitch is shown on the GraphicDisplay with presser foot, thread tension (835/855) and needle recommendations. Press the buttons for the fabric you are using and the sewing technique you wish to sew.

\*Only on 875 Quilt

## Sewing Mode, 835

Sewing Mode is the first view on the GraphicDisplay after you turn on the machine. Here you will find all the basic information you need to start sewing. This is also the menu where you adjust the settings of your stitch. Straight stitch is selected by default.

1. Recommended needle for the selected fabric.
2. Recommended presser foot for the selected stitch.
3. The sewing speed is indicated by three levels shown on the GraphicDisplay. Reduce or increase the speed by pressing the SPEED button.
4. The fabric and sewing technique selected on the Exclusive SEWING ADVISOR™ feature.
5. Recommended thread tension for the selected fabric and stitch.
6. The selected stitch, both illustrated and displayed by number.
7. Stitch length. Reduce or increase the stitch length by pressing the Stitch Length – and + buttons.
8. Needle position is shown instead of stitch width when straight stitch is selected. Change the needle position by pressing the Stitch Width – and + buttons.
9. Indicates that the function Mirror side to side is activated.
10. When sewing a manual buttonhole or the darning program the reverse icon is shown to indicate that you need to press the reverse button when the buttonhole columns or the darning stitch are sewn to the desired length.
11. Stitch density is shown instead of stitch length when a buttonhole, bartack or darning stitch is selected or when a satin stitch is selected and the Alternate View button is pressed. Reduce or increase the stitch density by pressing the Stitch Length – and + buttons.
12. Stitch width. Reduce or increase the stitch width by pressing the Stitch Width – and + buttons.
13. Buttonhole size indication when using the Sensor One-Step Buttonhole Foot. Set the size of the button by pressing the up and down arrow buttons.
14. Recommendation to use stabilizer under your fabric.
15. The icon for lowering the feed teeth is shown when free motion is activated or sewing on buttons is selected.
16. Set the number of stitches to sew on the button by pressing the up and down arrow buttons.
17. Recommendation to use the multipurpose tool/button reed when sewing on a button. Place the thin end of the multipurpose tool/button reed under the button when sewing on light fabrics. Use the thick end for heavier fabrics.

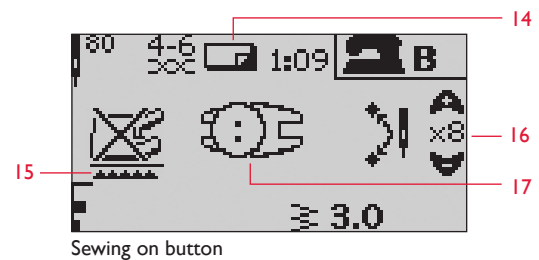
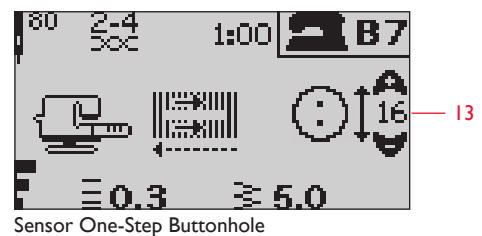
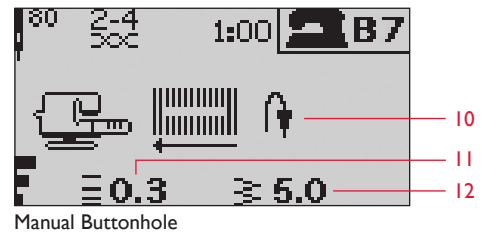
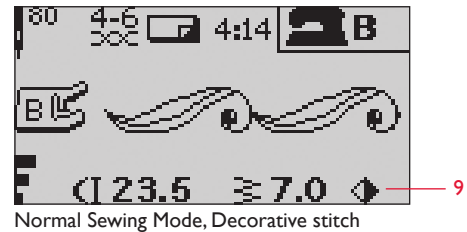
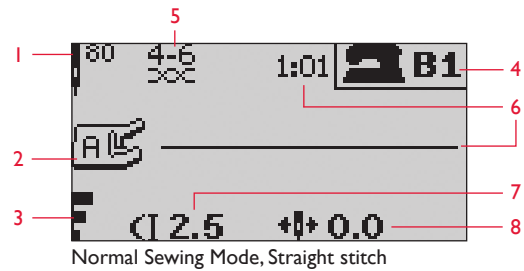

**NOTE:** When the value for stitch length/width/density or needle position is set to default the figures will be black. If you change the value, the figures will be inverted on a black background.

## Sewing Mode, 855/875 Quilt

Sewing Mode is the first view on the GraphicDisplay after you turn on the machine. Here you will find all the basic information you need to start sewing. This is also the menu where you adjust the settings of your stitch. Straight stitch is selected by default.

1. Recommended needle for the selected fabric.
2. Recommended presser foot for the selected stitch.
3. The sewing speed is indicated by three, or, for 875 Quilt, five levels shown on the GraphicDisplay. Reduce or increase the speed by pressing the SPEED button or, on the 875 Quilt: SPEED+ or SPEED- buttons.
4. The fabric and sewing technique selected on the Exclusive SEWING ADVISOR™ feature.
5. Recommended thread tension for the selected fabric and stitch. The recommendation is only shown on the 835 and 855 models. On the 875 Quilt model, the tension is set automatically.
6. The selected stitch, both illustrated and displayed by number.
7. Stitch length. Reduce or increase the stitch length by pressing the Stitch Length – and + buttons.
8. Needle position is shown instead of stitch width when straight stitch is selected, or on 875 Quilt, when the Alternate View button is pressed. Change the needle position by pressing the Stitch Width – and + buttons.
9. Indicates that the function Mirror end to end\* is activated
10. Indicates that the function Mirror side to side is activated.
11. Indicates that the stitch can be tapered when a Decorative Tapering Stitch\* is selected. Press the CLR button to open a view with tapering settings.
12. Indicates that tapering beginning\* is activated and the type of angle.
13. Indicates that tapering end\* is activated and the type of angle.
14. When sewing a manual buttonhole, the darning program or tapering stitches\*, the reverse icon is shown to indicate that you need to press the reverse button when the buttonhole columns, the darning stitch or the tapering stitch\* are sewn to the desired length.
15. Stitch density is shown instead of stitch length when a buttonhole, bartack or darning stitch is selected or when a satin stitch is selected and the Alternate View button is pressed. Reduce or increase the stitch density by pressing the Stitch Length – and + buttons.
16. Stitch width. Reduce or increase the stitch width by pressing the Stitch Width – and + buttons.
17. Buttonhole size indication when using the Sensor One-Step Buttonhole Foot. Set the size of the button by pressing the up and down arrow buttons.
18. Recommendation to use stabilizer under your fabric.
19. The icon for lowering the feed teeth is shown when free motion is activated or sewing on buttons is selected.
20. Set the number of stitches to sew on the button by pressing the up and down arrow buttons.
21. Recommendation to use the multipurpose tool/button reed when sewing on a button. Place the thin end of the multipurpose tool/button reed under the button when sewing on light fabrics. Use the thick end for heavier fabrics.

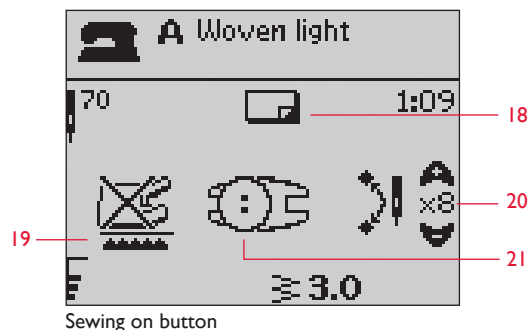
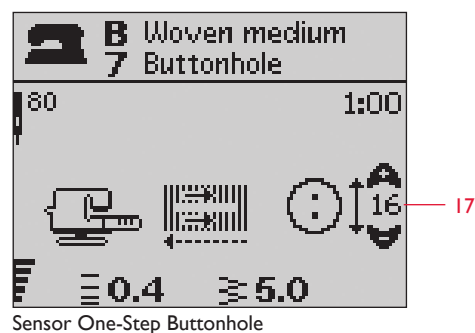
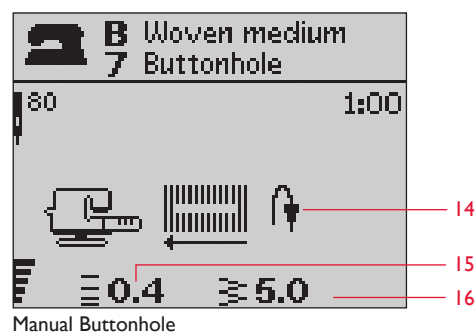
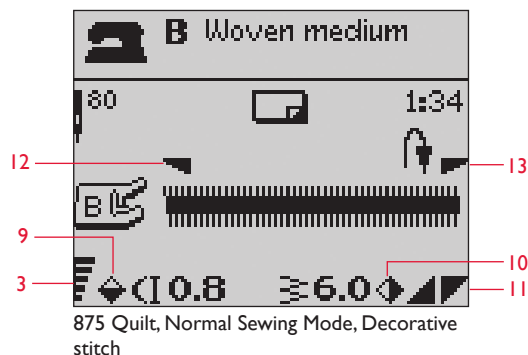
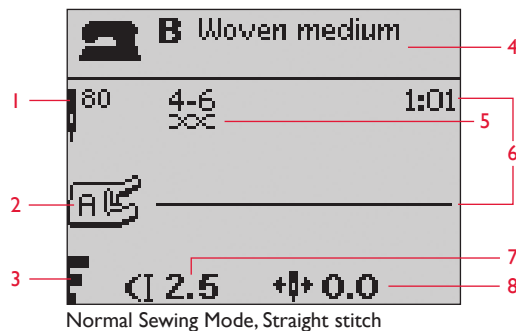

\*Only on 875 Quilt



## Selecting a stitch

Press the Stitch Menu button to select a stitch menu. Use the arrow buttons to select among the menus:

1. Utility stitches
2. Quilt stitches
3. Decorative stitches
4. Decorative stitches
- U. My Stitches

The name and number of the selected menu is shown at the bottom of the display. The stitches are pictured inside the lid of your machine with the menu numbers on the left and the stitch numbers within the menus across the center.

When you have selected the menu, press the number of the stitch you wish to use with the Stitch Selection buttons, or press OK and the first stitch in the selected menu will be selected (stitch number 10). Press the Stitch Menu button again to close the selection menu without making any selection.

Stitches 0-9 are the same in all stitch menus. If you press any of the Stitch Selection buttons once, you select the stitch illustrated on that button immediately, regardless of the selected stitch menu.

By pressing two digits in quick succession you will be able to select a stitch from 10 and up from the selected stitch menu. If the stitch number does not exist in the selected menu you will hear a beep and the first entered digit will be selected as a stitch.

The selected stitch menu, stitch and stitch number will be visible on the GraphicDisplay in Sewing Mode. To select another stitch in the same menu just press the number of the stitch or use the left and right arrow buttons to step stitch by stitch in numerical order. To select a stitch in another menu you will first need to change stitch menu and then select the stitch.

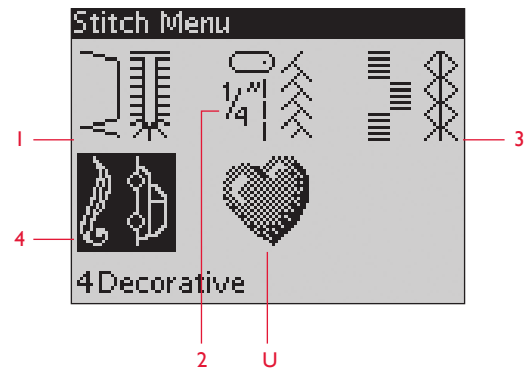

## Selecting a font

Press the Font Selection Menu button to open the Font Selection Menu. Use the arrow buttons to select among the fonts:

- 835: Block, Cyrillic Alphabet, Hiragana Alphabet
- 855: Block, Brush Line, Cyrillic Alphabet, Hiragana Alphabet
- 875 Quilt: Block, Brush Line, Script, Cyrillic Alphabet, Hiragana Alphabet

Press the OK button. This automatically opens the mode for programming letters, see page 25.

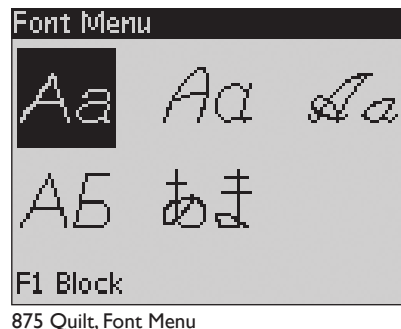
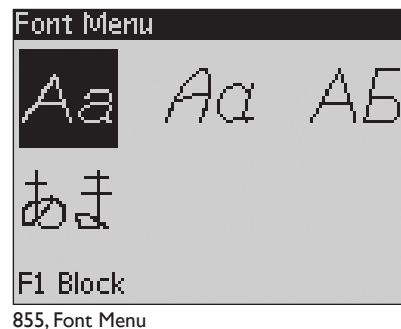

## PROG Programming

The Programming function on your machine makes it possible to create stitches with your own personal settings and to combine stitches and letters into stitch programs. You can add up to 40 stitches and letters in the same program. Save your own stitches and programs in My Stitches and recall them any time you like.

All stitches in your sewing machine are programmable except for buttonholes, darning, Automatic Tapering Stitches\*, button sewing and bartacks.

### Create a stitch program

1. Press the PROG button to open the mode for Programming.
2. The stitch menu which was previously selected will be kept when entering the Programming mode. To change the stitch menu, press the Stitch Menu button and select another stitch menu by using the arrow buttons.
3. Press the number of the stitch you wish to use. The stitch will appear in Programming Mode.
4. Press the number of the next stitch and it will appear to the right of the last entered stitch.

**NOTE:** Two numbers are displayed above the stitch program on the left side of the GraphicDisplay. The first number is the position of the selected stitch in the program. The second number, put in brackets, is the total number of stitches in the program. The number above the stitch program on the right side of the GraphicDisplay is the number of the selected stitch.

### Add letters

5. Press the Font Menu button. Use the arrow buttons to select a font and press OK. The machine will show the upper case alphabet in Programming Mode.
6. Use the arrow buttons to select a letter and press OK to add the letter to the program.
7. To switch to a lower case alphabet or numbers press the Shift button.

### About programming letters

Both upper and lower case letters will be stitched with a 7 mm stitch width. If there are letters going below the baseline included in the program (e.g. j, p, y) the height of the uppercase letters will be reduced.

All text to be sewn out on the same project, should be in the same program to ensure the letters are sewn out in the same height.

For instance, a name and an address should be in the same program with a STOP after the name.

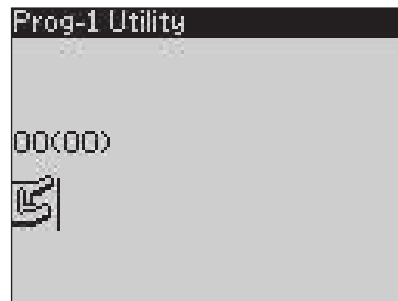

Programming Mode

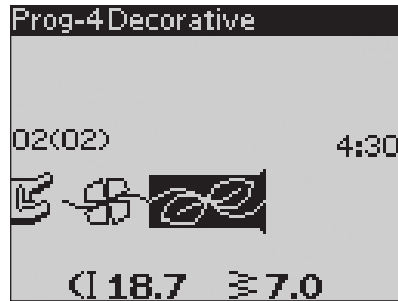

4.



6.

Husqvarna VIKING

"Husqvarna" and "VIKING" have been programmed separately.

Husqvarna VIKING

"Husqvarna" and "VIKING" are in the same program.



\*Only on 875 Quilt

## Add stitches or letters at other positions

If you wish to add a stitch or letter at another position in the program, move the cursor by pressing the arrow buttons. The stitch or letter will be inserted to the right of the cursor.

**NOTE:** When programming letters, press the arrow down button to activate the cursor in the stitch program instead of in the alphabet.

## Add the same stitch several times

If you want to add the same stitch several times in a row you can just press the OK button directly after the first stitch has been inserted. The same stitch will be inserted each time you press OK.

You can also move the cursor to select another stitch and press the OK button. The selected stitch will be inserted once more to the right of the selected stitch.

## Delete stitches or letters

To delete a stitch in the program, select the stitch with the cursor by pressing the arrow buttons and press the Clear (CLR) button.

To delete the whole program, move the cursor to the left of the first position and press the Clear (CLR) button. A pop-up will appear asking you to verify the deletion. Select Yes or No with the arrow buttons and press OK.

## Add commands

The commands FIX, STOP and Selective Thread Cut\* can be added to the program. Each command takes one memory space in the program.

**NOTE:** If autofix is activated on your machine you do not need to add a FIX in the beginning of the program.

## Join two stitch programs into one

You can add a previously saved program to a new one in Programming Mode. Press the Stitch Menu button, select My Stitches and the program you wish to add. Press OK and the program will be inserted in Programming Mode to the right of the cursor.

## Adjust a single stitch or letter

To adjust the settings of a single stitch in a program you must select the stitch in Programming Mode. You can adjust the stitch width, stitch length, density, needle or stitch position\* or mirror the stitch. The settings for the selected stitch are shown on the GraphicDisplay. Press the Alternate View button to toggle between different settings.



Add commands

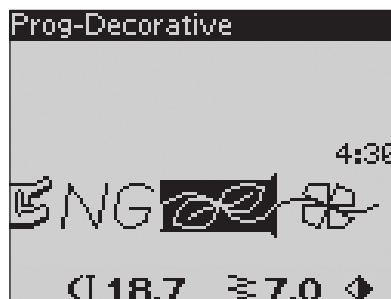

Adjust a single stitch or letter

## Adjust the entire stitch program

Adjustments that affect the whole program and not just single stitches, are done in Sewing Mode. Press the PROG button to leave Programming Mode and switch to Sewing Mode. In Sewing Mode you can adjust the width and length or mirror the whole program.

There are a few things you need to know when adjusting the stitch program in Sewing Mode:

The adjustments you make to the program in Sewing Mode can be saved to My Stitches. However, these adjustments cannot be brought back to Programming Mode. If you have made adjustments in Sewing Mode and press the PROG button to go back to Programming Mode, these adjustments will be cancelled. This will also happen if you load a saved program from My Stitches to Programming Mode.

If you have programmed a STOP, FIX or Selective Thread Cut\* and mirror the program end to end\*, the commands will change positions just as the stitches. This might not give the result you intended.

## Sew out the stitch program

When you are done with your program press the My Stitches button to save it (see next page) or, if still in Programming Mode, press the PROG button or step on the foot control to switch to Sewing Mode.

Once you are in Sewing Mode and step on the foot control the machine will sew out your stitch program. The program will be sewn continuously if no STOP is programmed. Press the STOP button to sew your stitch program only once.

It is possible to start sewing at any stitch in the program. Use the left/right arrow buttons to step through the program in Sewing Mode.

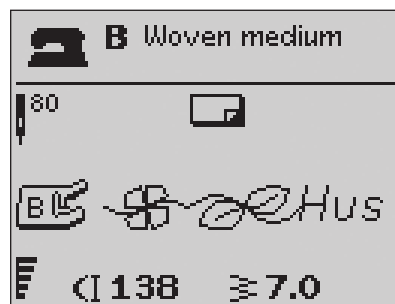

Sewing Mode



## →♥ My Stitches Menu

My Stitches is your own personal menu where you can save and recall your programs or favorite stitches with personal settings.

Model 835 has 10 memories, model 855 has 15 memories and model 875 Quilt has 20 memories.

Each memory has a maximum space of 40 stitches.

### Save a stitch or a program

Press the My Stitches button from Programming or Sewing Mode. This will open the My Stitches Menu. Select an empty memory by pressing the up/down arrow buttons. Confirm your selection by pressing the OK button. If the selected memory is not empty, a pop-up message will appear asking if you wish to overwrite the previously saved stitch/program with the new one. Select Yes or No with the arrow buttons and press the OK button. Press the My Stitches button again to return to Sewing Mode or Programming Mode.

### Load a saved stitch or program

To load a saved stitch or program from My Stitches, press the Stitch Selection Menu button and open the My Stitches Menu. Use the arrow buttons to select the stitch or program and press OK. The stitch/program will appear in Sewing Mode ready to be sewn.

### Delete saved stitches or programs

To delete a stitch or a program from My Stitches, press the Clear button (CLR) when the stitch/program is selected. A pop up will appear asking you to verify the deletion. Select Yes or No with the arrow buttons and press OK. Press the My Stitches buttons again to return to the previous menu.

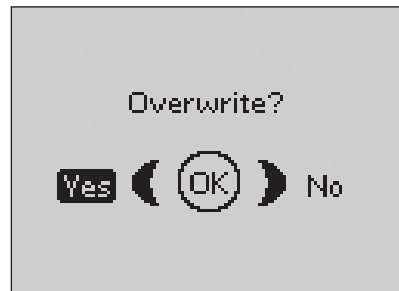

## SET Menu

You can change the pre-set machine settings and make manual adjustments to the automatic functions in the SET Menu. Open the menu by pressing the SET Menu button and select the setting you wish to adjust by pressing the up/down arrow buttons. To activate the function, press the OK button to place an X in the box. To cancel the function, press the OK button again to leave the box empty. To change the number settings, use the right/left arrow buttons. Press the SET Menu button again to close the SET Menu.

**NOTE:** When a number is set to default the figures will be black. If you change the number the figures will be inverted on a black background.

### Presser foot pressure

Use the left/right arrow buttons if you want to adjust the presser foot pressure for the selected stitch. The value can be adjusted between 0 and 8.5 in steps of 0.5. Your manual setting will be cancelled when you select another stitch or turn off the machine.

**NOTE:** When you save a stitch or program in My Stitches the setting of the presser foot pressure is also saved.

### Pivot height

If Free Motion is activated you will be able to set the height of the presser foot pivot position. The pivot position can be raised or lowered in 15 steps by pressing the left/right arrow buttons.

### Sensor Foot auto

Press the OK button to turn on or off the automatic pivot function for lifting the presser foot for example when stopping with the needle down. The setting will go back to default when the machine is turned off.

### FIX auto

Press the OK button to turn on or off the automatic FIX function in the beginning of each stitch. The setting will go back to default when the machine is turned off.

### Automatic thread tension (Only on 875 Quilt)

The 875 Quilt will automatically set the best thread tension for the selected stitch and fabric. Use the left/right arrow buttons if you need to adjust the thread tension. The changes only affect the selected stitch. If another stitch is selected or the same stitch is selected again, the value is reset to the default value. The setting will go back to default when the machine is turned off.

### Selective Thread Cutter (Only on 875 Quilt)

The Selective Thread Cutter will automatically cut the threads and the presser foot will lift after a buttonhole or eyelet is sewn. Press the OK button to turn off the cut function. The setting will go back to default when the machine is turned off.

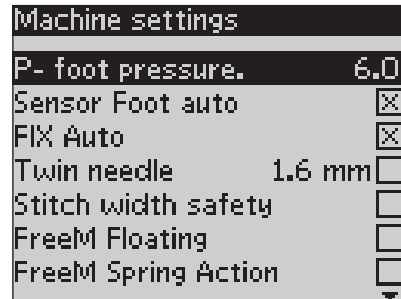

855, Machine SET Menu

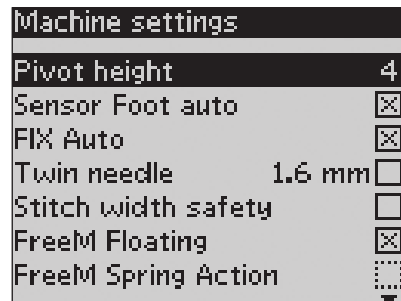

855, Machine SET Menu

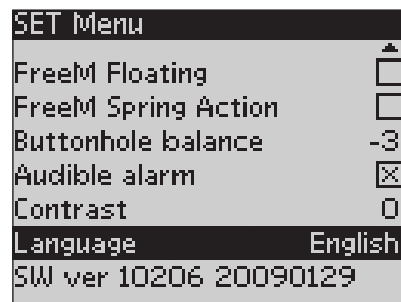

855, Machine SET Menu

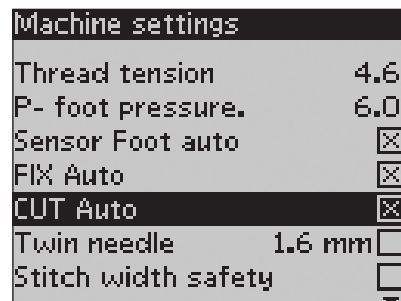

875 Quilt, Machine SET Menu

## Twin needle

If you are using a twin needle, set the size of the needle to limit the width of all stitches and prevent needle breakage. Activate or deactivate the twin needle function with the OK button and use the left/right arrow buttons to set the twin needle size. Your setting will be saved even when the machine is turned off. A pop-up message reminds you of the setting when you turn on the machine. Close the pop-up message by pressing OK.

**NOTE:** You cannot set the twin needle size if the Stitch Width Safety is on, or turn on the Stitch Width Safety if the machine is set for twin needle.

## Stitch Width Safety

Use the OK button to turn on the Stitch Width Safety when using a straight stitch needle plate or a straight stitch presser foot. The stitch width will be limited to zero for all stitches to prevent damage to the needle, presser foot and needle plate. This setting is saved when the machine is turned off. A pop-up message reminds you of the setting when you turn on the machine. Close the pop-up message by pressing OK.

## Buttonhole balance

If the Sensor One-Step Buttonhole Foot is not connected or if you select stitch 1:25, the columns in the buttonhole stitch will be sewn in different directions. On some fabrics this may cause the columns to appear with different density. Use the left/right buttons to balance the density between -7 and 7. The changes only affect the selected stitch. If another stitch is selected or the same stitch is selected again, the value is reset to the default value.

## Free Motion Floating\*

To sew in free motion with the included Embroidery/Darning Foot R or with any optional Free Motion Floating presser foot, set the machine in Free Motion Floating mode. The drop feed teeth recommendation will be activated. The setting remains when the machine is turned off. A pop-up reminds you of the setting when you turn on the machine. Close the pop-up message by pressing OK.

**NOTE:** You cannot set the machine in Free Motion Floating Mode if Free Motion Spring Action is activated or vice versa.

## Free Motion Spring Action\*\*

If you are using any of the optional Free Motion Spring Action presser feet, you need to set the machine in Free Motion Spring Action mode. The drop feed teeth recommendation will be activated. The setting remains when the machine is turned off. A pop-up message reminds you of the setting when you turn on the machine. Close the pop-up message by pressing OK.

## Audible Alarm

Turns on or off all alarm sounds of the machine. Default setting is on. This setting is saved even if the machine is turned off.

## Contrast

Adjust the contrast of the GraphicDisplay by using the left/right arrow buttons. The value can be set between -20 to 20 in steps of 1. The setting is stored even when the machine is turned off.

## Language

Use the left/right arrow buttons to change the language of all text in your machine. The language setting is saved even if the machine is turned off.

## Software Version

The software version currently loaded for the sewing machine is displayed.

### \*Free Motion Floating

When you are sewing free motion in low speed the foot will raise and lower with each stitch to hold the fabric on the stitch plate while the stitch is being formed. When sewing in high speed, the foot floats over the fabric while sewing. The feed teeth must be lowered and the fabric is moved manually. All stitches can be sewn in free motion mode.

### \*\*Free Motion Spring Action

The Free Motion Spring Action presser feet follows the up and down movement of the needle with help of the spring and the arm on the presser foot. The feed teeth must be lowered and the fabric is moved manually. It is recommended to turn on the Stitch Width Safety for the presser feet that are only intended for straight stitch sewing.

## Pop-up messages

### Bobbin winding on

This pop-up message appears when the bobbin winding spindle is pushed to the right and bobbin winding is activated.

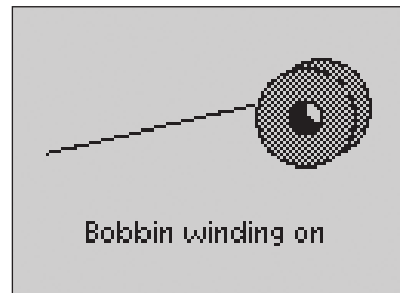

### Presser foot too high

Your machine will not sew if there is too much fabric under the presser foot. Remove some of the fabric or use another fabric. Press the OK button, or tap the foot control to close the pop-up message.



### Machine set for twin needle

When you have set the machine for twin needle in the SET Menu, a pop-up message is shown to remind you of the setting when you turn on your machine. Press the OK button or tap the foot control to close the pop-up message.

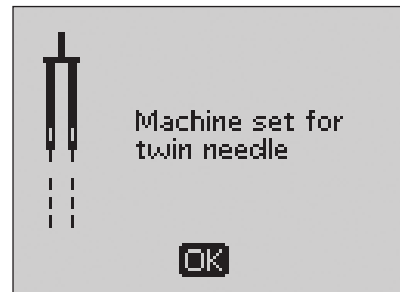

### Stitch width limited for twin needle

This message is shown when the machine is set for twin needle and you try to adjust the stitch width to wider than possible with the twin needle. Close the pop-up message by pressing the OK button.

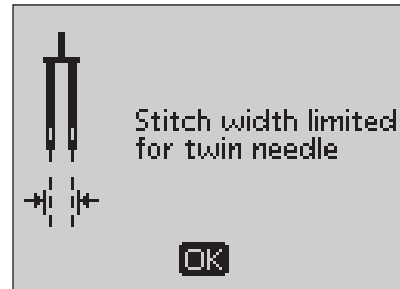

### Machine set for straight stitch

This message is shown when the stitch width safety is on and you turn on the machine or try to adjust the stitch width. Close the pop-up message by pressing the OK button.

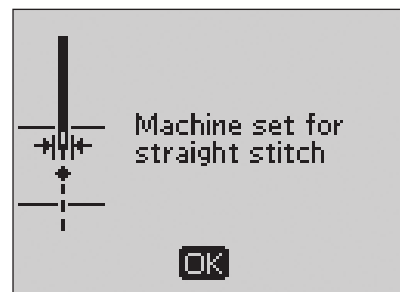

### This stitch cannot be sewn with twin needle

This pop-up message appears when the machine is set for twin needle and you select a stitch that cannot be sewn with twin needle. Press the OK button to close the pop-up message.



## Restart the buttonhole?

If you are sewing a buttonhole and stop to adjust the length settings you will get this question once you start sewing again. If you select “Yes”, the machine will restart and sew the buttonhole from the beginning with the new settings. If you select “No”, the change will be cancelled and the machine will continue sewing the rest of the buttonhole with the previous settings. Use the arrow buttons to select “Yes” or “No” and press the OK button.



## Sensor One-Step Buttonhole Foot line up - “Adjust white area to white line”

When you insert the fabric for sewing a buttonhole, the wheel of the Sensor One-Step Buttonhole Foot might move. A pop-up message prompts you to line up the white area with the white line. Line up the white areas and close the pop-up message by pressing the OK button.



## Sensor One-Step Buttonhole Presser Foot connected

The Sensor One-Step Buttonhole Foot can only be used for the buttonhole stitches recommended for the foot. If the Sensor One-Step Buttonhole Foot is connected and you select a stitch that is not possible to sew with the foot, this message will appear when you start to sew. Remove the foot or select a buttonhole that can be sewn with the Sensor One-Step Buttonhole Foot. Close the pop-up message by pressing the OK button.

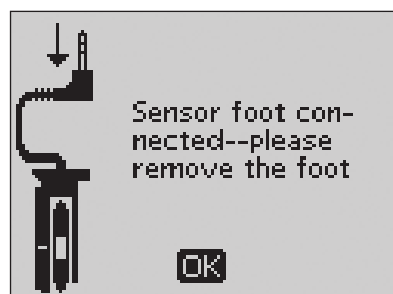

## Machine set for free motion sewing

This message is shown when the machine is set to Free Motion Floating or Free Motion Spring Action and you turn on the machine. Close the pop-up message by pressing the OK button.



## Bobbin thread low (Only on 875 Quilt)

Your machine stops when the bobbin is almost empty. Replace the empty bobbin with a full one and close the pop-up message by pressing the OK button.

**NOTE:** Continue sewing without closing the pop-up message if you want all thread on the bobbin to run out.

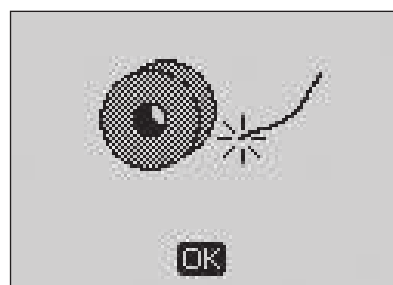

## Remove thread from under stitch plate and in bobbin area (Only on 875 Quilt)

When this pop-up message appears clean thread and lint from the area under the stitch plate to allow the Selective Thread Cutter to cut properly. Close the pop-up message by pressing the OK button.



## Main motor overload

If you are sewing on very heavy fabric or if the machine is blocked when sewing, the main motor can get overloaded. The pop-up message will close when the main motor and power supply is secure.

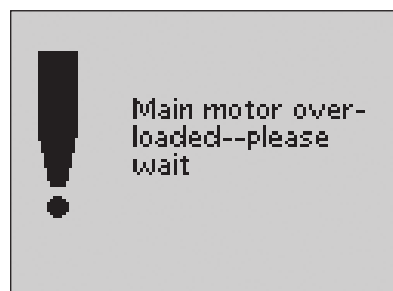

## The stitch cannot be programmed

This message is shown if you try to program or add a buttonhole, bartack or Automatic Tapering stitches\* or the sew on button stitch to a program. All stitches in your sewing machine are programmable except for these. Close the pop-up message by pressing the OK button.



## The stitch cannot be saved

This message is shown if you try to save a buttonhole, bartack, darning or Automatic Tapering stitches\* or the sew on button stitch to My Stitches. All stitches in your machine can be saved in My Stitches except for these. Close the pop-up message by pressing the OK button.



## Program too long to add more stitches

If you try to add more than 40 stitches or letters in the same program this message is shown. Close the pop-up message by pressing the OK button.

**NOTE:** If you add a FIX, STOP or a Selective Thread Cut\* to the program these will each use one memory space in the program.



## The combination of commands is incorrect

If you are programming stitches or letters and try to insert any of the commands STOP, FIX or Selective Thread Cut\* into a stitch program in an order that is not allowed, this message will appear. Close the pop-up message by pressing the OK button.



## Commands removed from program

If you try to insert a previously saved program into a new one or if you are using the mirroring end to end function\* on the whole program, the result may be that the commands are put in an order that is not allowed. To avoid this, the commands will be removed from the program. Close the pop-up message by pressing the OK button.

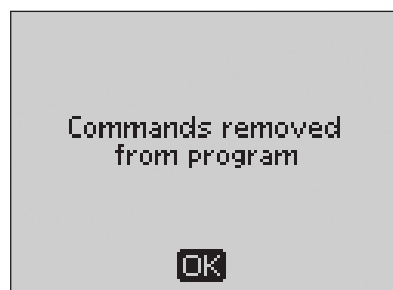

\*Only on 875 Quilt





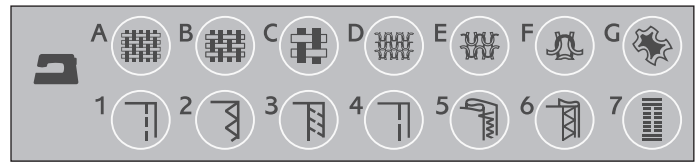

## Exclusive SEWING ADVISOR™

Your sewing machine has the Exclusive HUSQVARNA VIKING® SEWING ADVISOR™ feature. The Exclusive SEWING ADVISOR™ feature automatically sets the best stitch, stitch length, stitch width, thread tension\*, sewing speed and sensor foot pressure for your project. The stitch is displayed on screen with presser foot, thread tension and needle recommendations.

Press the buttons for fabric type and sewing technique desired.







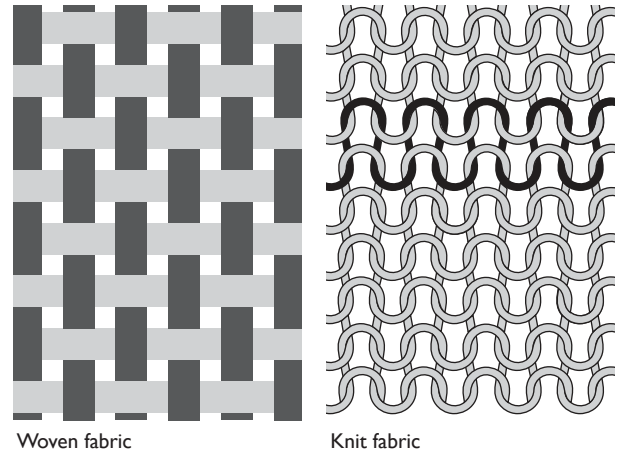

### Fabric Selection

-  **WOVEN LIGHT:** chiffon, organza, batiste, silk, wool challis, etc.
-  **WOVEN MEDIUM:** calico, quilting fabrics, wool crepe, broadcloth, etc.
-  **WOVEN HEAVY:** denim, wool suiting and coating, canvas, terrycloth, quilt layers with batting, etc.
-  **STRETCH LIGHT:** charmeuse, nylon, tricot, single knit jerseys, etc.
-  **STRETCH MEDIUM:** double knit, velour, swimwear, etc.
-  **STRETCH HEAVY:** sweater knits, fleece, etc.
-  **LEATHER AND VINYL:** suede, leather, vinyl and synthetic leather.



### Sewing technique

-  **SEAM:** sews two pieces of fabric together.
-  **OVERCAST:** finish fabric edges to prevent them from fraying and to help them lay flat.
-  **SEAM/OVERCAST:** sews the seam and overcasts the edge all at one time.
-  **BASTE:** a temporary stitching for fitting garments, gathering and marking. The Exclusive SEWING ADVISOR™ feature automatically sets a long stitch length and reduces the tension\* so the threads are easy to remove or to pull for gathering.
-  **BLIND HEM:** creates an invisible hem on garments. Is not recommended for light weight fabric or for leather/vinyl.
-  **HEM:** selects the best visible or top stitch hem for your fabric type and weight.
-  **BUTTONHOLE:** the Exclusive SEWING ADVISOR™ feature selects and sets the best buttonhole for your fabric.

**NOTE:** If an unsuitable combination is selected (for example woven light-blind hem), the machine beeps and the technique remains unselected.

## Seam

A seam sews two pieces of fabric together with a seam allowance that usually will be pressed open. In most cases, edges of the seam allowance are finished with an overcast stitch before sewing the seam.

Seams on stretch fabric must stretch with the fabric. The Stretch Stitch makes a stretchy seam that is suitable for sewing together pieces of light stretch fabric.

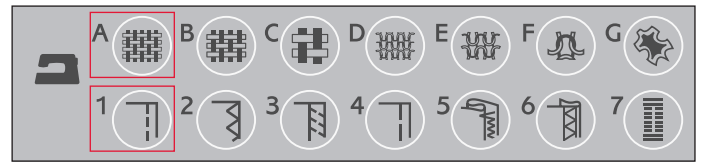

### 1:1 Straight Stitch

**Fabric:** Woven medium, cut in two.

**Select:** Woven medium fabric and Seam technique (The Exclusive SEWING ADVISOR™ feature selects a straight stitch).

**Use:** Presser Foot A and size 80 needle as recommended.

Line up the fabric edge with the 5/8" (15 mm) seam guide.

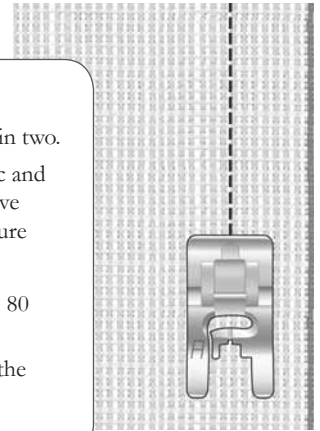

### 1:2 Stretch Stitch

**Fabric:** Stretch light, cut in two.

**Select:** Stretch light fabric and Seam technique (The Exclusive SEWING ADVISOR™ feature selects the Stretch Stitch).

**Use:** Presser Foot A and size 75 stretch needle as recommended.

Line up the fabric edge with the 3/8" (10 mm) seam guide.

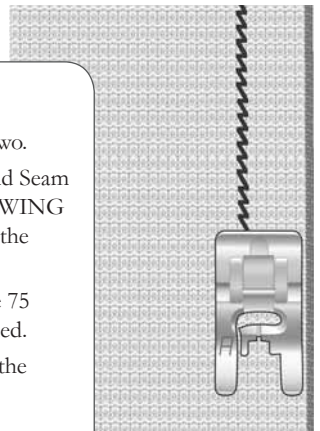

## Edge/Quilting Guide (Only on 875 Quilt)

The Edge/Quilting Guide is used for wide seam allowances, topstitching, or channel quilting. Slide the guide into the clip on the ankle. Adjust to the desired position.

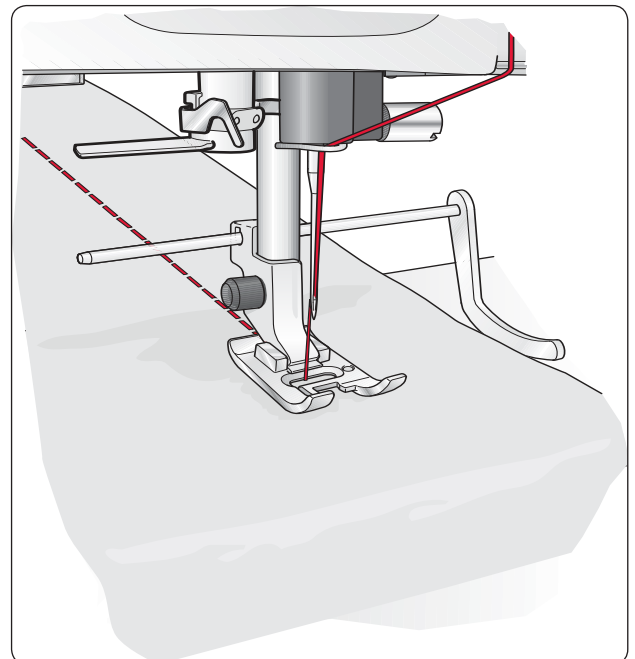

## Overcast

The three-step zigzag, is up to 1/4" (6mm) wide and suitable for all types of fabrics. Use this stitch for overcasting, butting two edges together to join them, mending tears and other special finishing.

Use Edging Foot J when overcasting.

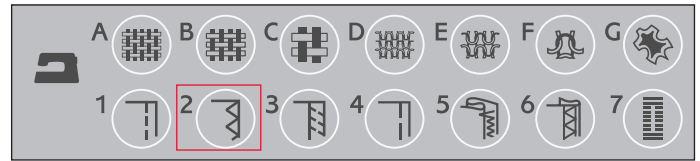

### 1:13 Three-Step Zigzag

**Fabric:** All types of fabric.

**Select:** The fabric you are using and Overcast technique (The Exclusive SEWING ADVISOR™ feature selects the three-step zigzag).

**Use:** Presser Foot J and the needle recommended for your fabric.

Let the toe of the presser foot guide the fabric as shown on the picture.

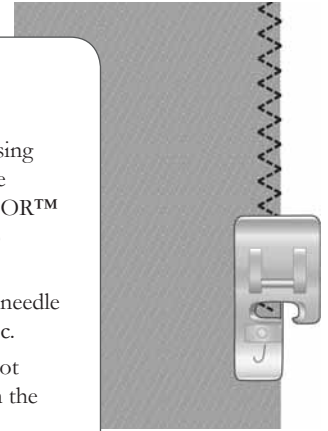

## Seam and overcast

The Seam/Overcast stitch sews the seam and overcasts the edge all at one time. There are a number of different Seam/Overcast stitches on your sewing machine, to give the best result for your chosen fabric.

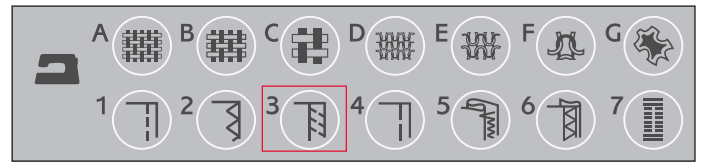

### 1:7 Overcast Stitch

**Fabric:** Stretch light or woven light/medium, cut in two.

**Select:** Stretch light or woven light/medium fabric and Seam/Overcast technique (The Exclusive SEWING ADVISOR™ feature selects the Overcast Stitch).

**Use:** Presser Foot J and the needle recommended for your fabric.

Let the toe of the presser foot guide the fabric as shown on the picture.

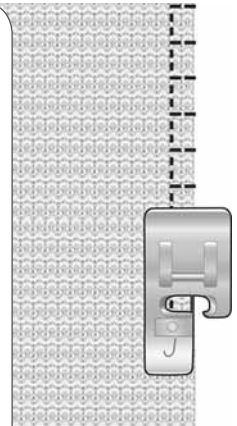

### 1:8 Stretch Seam Overcast Stitch

**Fabric:** Stretch heavy, cut in two

**Select:** Stretch heavy fabric and Seam/Overcast technique (The Exclusive SEWING ADVISOR™ feature selects the Overlock Stitch).

**Use:** Presser Foot B and size 90 stretch needle as recommended.

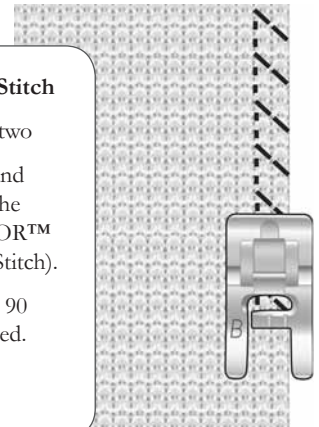

### 1:10 Double Overlock Stitch

**Fabric:** Woven heavy, cut in two.

**Select:** Woven heavy fabric and Seam/Overcast technique (The Exclusive SEWING ADVISOR™ feature selects the Double Overlock Stitch).

**Use:** Presser Foot B and size 80 needle as recommended.

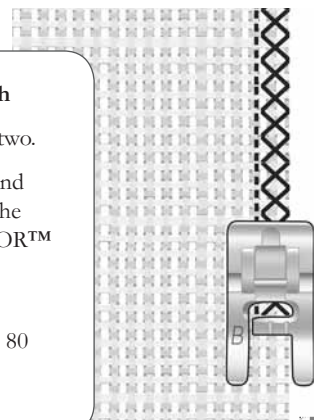

## Baste

Basting is temporary stitching for fitting garments, gathering and marking.

The Exclusive SEWING ADVISOR™ feature automatically sets a long stitch length and reduces the tension\* so the threads are easy to remove or to pull for gathering.

Place the fabrics right sides together. Put the fabric in position under the presser foot with 5/8" (15 mm) seam allowance. Stitch along seam line.

To remove stitching pull the bobbin thread.

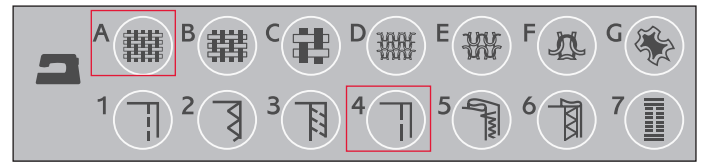

### 1:15 Baste Stitch

**Fabric:** All types of fabric.

**Select:** The fabric you are using and baste. (The Exclusive SEWING ADVISOR™ feature selects the Baste stitch)

**Use:** Presser Foot A and the needle recommended for your fabric.

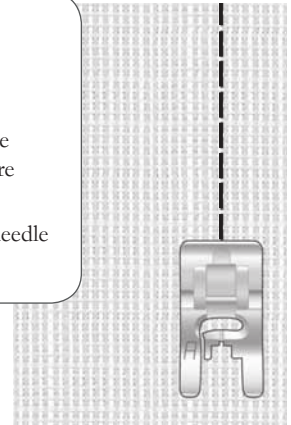

## Darning and mending

Darning a small hole or a tear before it becomes larger can save a garment. Choose a fine thread in a color as close to your garment as possible.

1. Place the fabric in position under the presser foot.
2. Start sewing above the hole and over it.
3. Once over the hole, press the Reverse button. Continue sewing. The machine sews back and forth across the hole 14 times and then stops.
4. To repeat the stitch with the same size, press the STOP button. Reposition your fabric, then step on the foot control to sew again. The stitch will now repeat the same size darning square. The machine will stop automatically when the stitch is completed.

### 1:21 Darning Stitch

**Fabric:** All types of fabric.

**Select:** The fabric you are using and stitch 1:21.

**Use:** Presser Foot A and the needle recommended for your fabric.

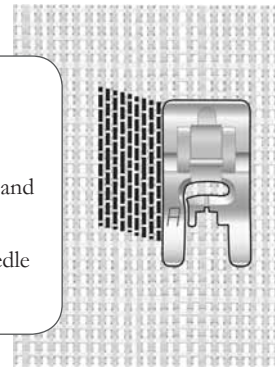

## Blind hem

The blind hem creates an invisible hem on garments. There are two types of blind hem; one is recommended for medium to heavy stretch fabric, the other for medium to heavy woven fabric.

Fold the fabric as illustrated. Make sure the folded edge of the fabric follows the inside of the right “toe” of Blind Hem Foot D.

The left swing of the needle should just catch the edge of the folded fabric.

If necessary, adjust the stitch width as needed to barely “catch” the fold.

**NOTE:** The blind hem technique is not recommended for light weight fabric or leather/vinyl. If you select the blind hem and light woven, light stretch or leather and vinyl you will hear a beep and the technique will be unselected.

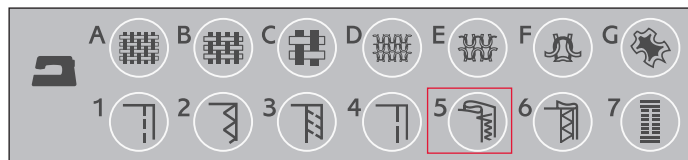

**1:16 Stretch Blind Hem Stitch**

**1:17 Woven Blind Hem Stitch**

**Fabric:** Stretch medium/heavy or woven medium/heavy

**Select:** The fabric you are using and the Blind hem technique (The Exclusive SEWING ADVISOR™ feature selects the Blind Hem Stitch no. 1:16 or 1:17).

**Use:** Blind Hem Foot D and the needle recommended for your fabric.

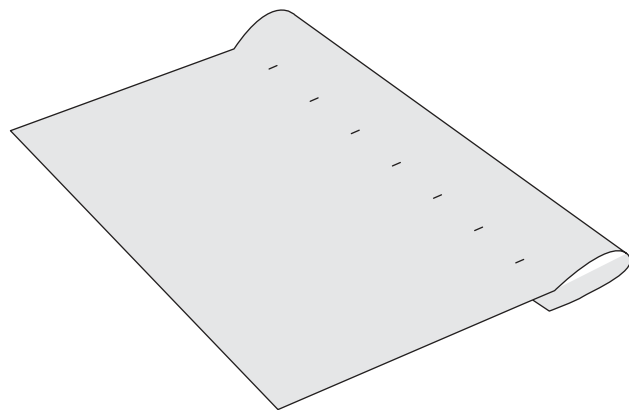
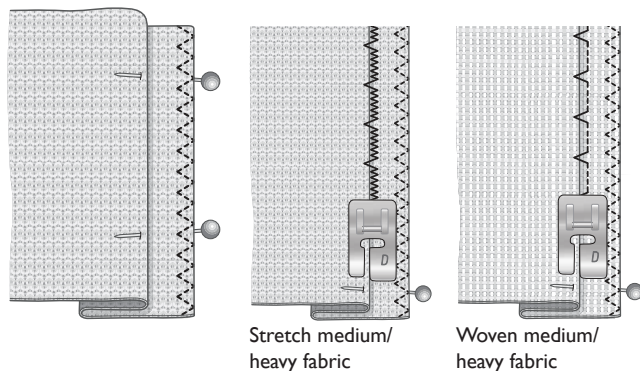

3

## Hem

The Hem technique on your Exclusive SEWING ADVISOR™ feature will select the visible or topstitch hem that is best for your fabric weight and type. For woven fabric and leather and vinyl, a straight stitch is selected. For stretch fabrics, stitches that stretch are selected.

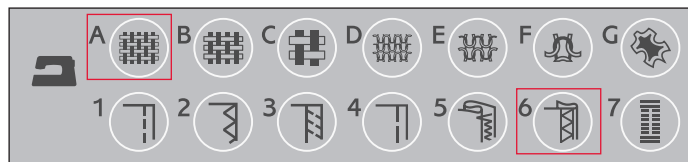

## Jeans Hem

When sewing over seams in extra heavy fabric or a jeans hem, the presser foot may tip as it rides over the seam. Use the multipurpose tool to balance the height of the presser foot as you sew.

Press Needle Up/Down to select the needle down position. Begin sewing the bottom hem at or near the center back. As you near the side seam, stop sewing. Your machine stops with the needle in the fabric and raises the presser foot. Insert the multipurpose tool from behind.

Both sides of the multipurpose tool are raised. Use the side which corresponds closest to the thickness of the seam. Step on the foot control to lower the presser foot and continue sewing slowly over the thick seam.

Stop sewing again just in front of the seam with the needle in the fabric. Remove the multipurpose tool and re-insert it under the presser foot from the front.

Sew a few stitches until the whole presser foot has passed the seam and is resting on the multipurpose tool. Stop sewing once again. The needle is in the fabric, and the presser foot lifts. Remove the multipurpose tool. Continue sewing the hem.

### 1:1 Jeans hem

**Fabric:** Denim fabric.

**Select:** Woven heavy and Hem (The Exclusive SEWING ADVISOR™ feature selects a straight stitch 1:1).

**Use:** Presser Foot B as recommended and size 80 denim needle.

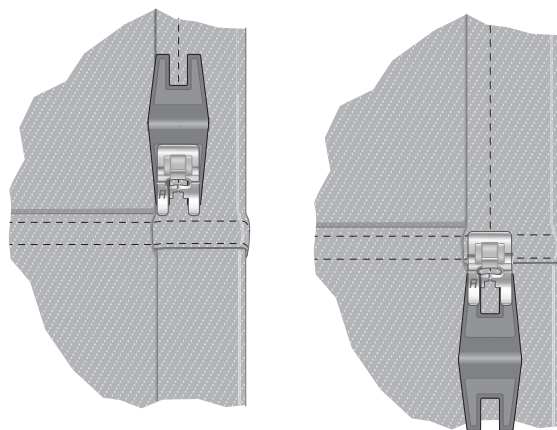

## Stretch Hem

Select Stretch Medium and Hem and the Exclusive SEWING ADVISOR™ feature selects a flatlock stitch. Follow other recommendations given on the GraphicDisplay.

Fold a hem to the wrong side and stitch with flatlock stitch from the right side. Trim away excess fabric. Use this technique to make belt loops, too.

### 1:6 Flatlock Stitch

**Fabric:** Stretch Medium

**Select:** Stretch Medium and Hem (The Exclusive SEWING ADVISOR™ feature selects the Flatlock Stitch 1:6).

**Use:** Presser Foot B as recommended and size 90 needle

Flatlock stitch to hem stretch fabric and for belt loops.

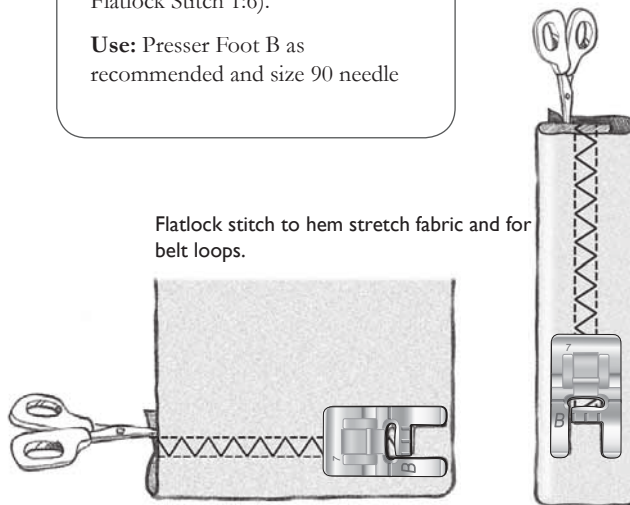

## Sewing buttonholes

The buttonholes in your sewing machine are specially adjusted for different kinds of fabric and garments. Look at the stitch table on the last pages in this book to find descriptions of each buttonhole.

The Exclusive SEWING ADVISOR™ feature will select the best buttonhole and stitch settings for your fabric. Fabric should be interfaced and/or stabilized where buttonholes are to be sewn.

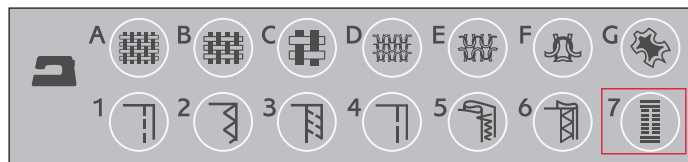

### Automatic One-Step Sensor Buttonholes

When you select a buttonhole stitch with the Sensor One-Step Buttonhole Foot connected, you will be able to set the size of the button on the GraphicDisplay using the up and down arrow buttons. When sewing, your sewing machine automatically sews the buttonhole long enough to fit the selected button size. Because the Sensor One-Step Buttonhole Foot measures as it sews, every buttonhole will be the same size.

**NOTE:** The buttonhole size will vary with the thickness and style of your button. Always stitch a sample buttonhole on scrap fabric first.

1. Attach the Sensor One-Step Buttonhole Foot.
2. Plug the cord into the socket above the needle area, behind the light bulb.
3. Measure the button diameter using the button measuring chart on the front of the machine.
4. Use the up and down arrow buttons to set the button size on the GraphicDisplay. The size can be set between 0-50 mm.
5. Place the fabric and stabilizer under the Sensor One-Step Buttonhole Foot. The measurement wheel can be raised by lifting it, which makes it easier to place the fabric under the presser foot. Use the markings on the left toe of the Sensor One-Step Buttonhole Foot to position the garment edge. Place the edge of the garment at the middle mark to have 5/8" (15 mm) from the edge to the buttonhole.
6. Before sewing, line up white area on the side of the red wheel with the white marking line on the foot.
7. Step on the foot control. The Sensor One-Step Buttonhole Foot lowers automatically. A straight stitch is sewn away from you stabilizing the left buttonhole column, then the satin column is sewn toward you. This is repeated for the right column. The bartacks are also sewn automatically. The arrows on the GraphicDisplay will show when each part of the buttonhole is sewn and in what direction. Keep the foot control depressed until the buttonhole is finished. The machine will stop automatically when the buttonhole is complete.

1:0, 1:23, 1:25, 1:26, 1:27 Buttonhole Stitches

**Fabric:** All types of fabric.

**Select:** The fabric you are using and the Buttonhole technique (The Exclusive SEWING ADVISOR™ feature selects a buttonhole suitable for your fabric).

**Use:** The Sensor One-Step Buttonhole Foot and the needle recommended for your fabric.

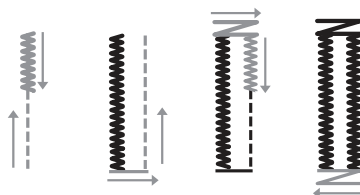
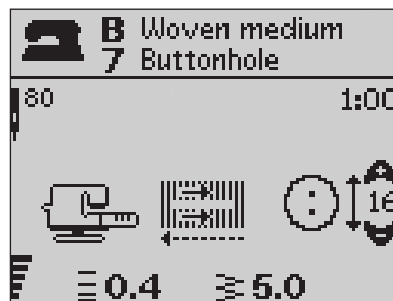
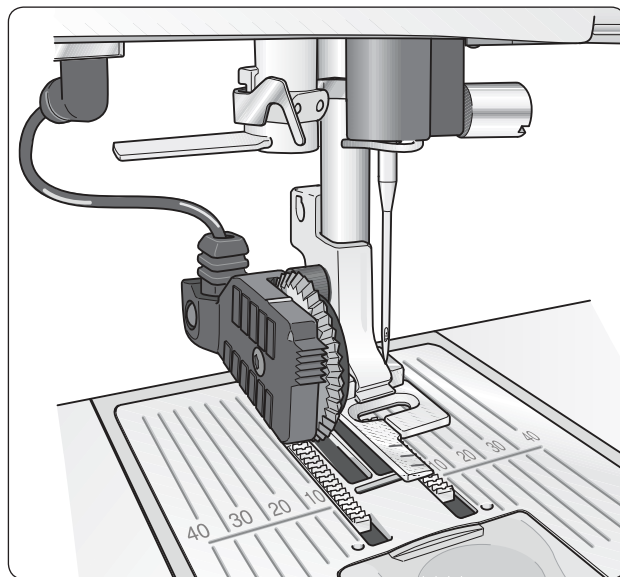

## Manual Buttonholes

A buttonhole can also be sewn step by step without the Sensor One-Step Buttonhole Foot connected. Use the reverse button to set the length of the buttonhole.

1. Snap on Presser Foot C.
2. Place the fabric and stabilizer under the presser foot. Use the markings on the left toe of the buttonhole foot to position the garment edge. Place the edge of the garment at the middle mark to have 5/8" (15 mm) from the edge to the buttonhole.
3. Begin sewing the buttonhole. The sewing machine will sew the left column in reverse. A reverse icon is shown on the GraphicDisplay indicating that you need to press the Reverse button to step to the next part of the stitch. When the buttonhole has reached the desired length, press the Reverse button. Your sewing machine will bartack the end and stitch the right side.
4. Sew to the starting mark and press the Reverse button to sew the second bartack. Keep the foot control depressed until the buttonhole is finished. The machine will stop automatically when the buttonhole is complete.

### 1:0, 1:23-28 Buttonhole Stitches

**Fabric:** All types of fabric.

**Select:** The fabric you are using and the Buttonhole technique (The Exclusive SEWING ADVISOR™ feature selects a buttonhole suitable for your fabric).

**Use:** Presser Foot C and the needle recommended for your fabric.

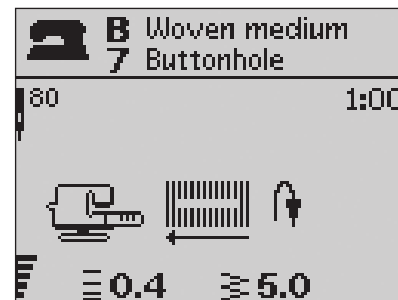
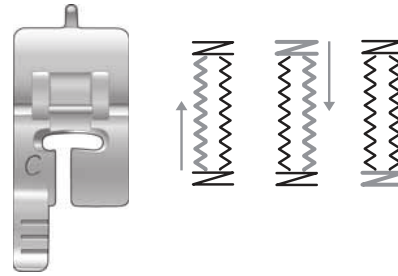

## Corded Buttonhole (Stretch fabrics)

When sewing buttonholes in stretch fabrics we recommend cording the buttonhole to increase the stability and to keep the buttonhole from stretching out.

1. Loop a piece of heavy thread or gimp cord over the finger on the back of Presser Foot C.
2. Stitch a buttonhole. Let the satin buttonhole columns stitch over the cord.
3. Stop sewing before the last end of the buttonhole is sewn. Lift the cord off the finger and pull out the slack.
4. Cross the cord in front of the needle and stitch the end of the buttonhole over the cord.



## Sewing on buttons

Sew buttons, snaps, hooks and eyes quickly with your sewing machine.

1. Snap off the presser foot and lower the feed teeth.
2. Place the fabric, multipurpose tool/button reed and button under the ankle with the holes in the button lined up with the swing of the needle. Check the swing of the needle by pressing the mirror side to side button to be sure the needle will not hit the button. Bring the needle down into the holes of the button with the hand wheel to verify.

**NOTE:** The recommended width of 3.0 is set for most buttons. If you sew a tiny button or a very large coat button, decrease (-) or increase (+) the stitch width until the swing of the needle sews in the holes of the button.

3. Set the number of stitches to sew on the button by pressing the up and down arrow buttons. Six to eight stitches is normal.
4. Press the foot control. The sewing machine will sew the number of stitches set on the display and then tie off and stop.
5. Raise feed teeth when button sewing is completed.

**TIP:** Place the thin end of the multipurpose tool/button reed under the button when sewing on light fabrics. Use the thick end for heavier fabrics. Hold in place on the fabric with transparent tape.

### 1:9 Sew on button

**Fabric:** All types of fabric.

**Select:** The fabric you are using and the stitch for sewing on buttons, 1:9.

**Use:** The needle recommended for your fabric. Do not use a presser foot.

Lower the feed teeth.

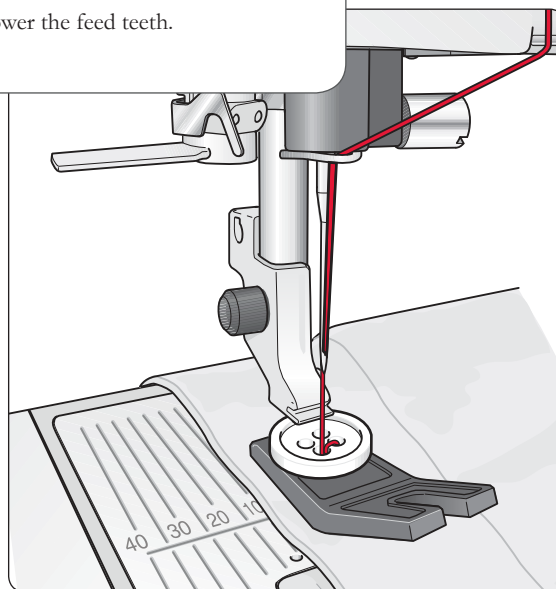

## Sewing zippers

The Zipper Foot E can be snapped on either the right or the left of the needle, making it easy to sew both sides of the zipper. To sew the other side of the zipper, reposition the Zipper Foot.

Move the needle position far left or far right to stitch close to the zipper teeth or cording.

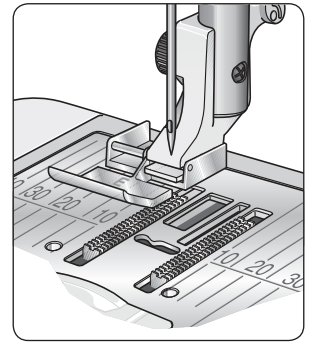
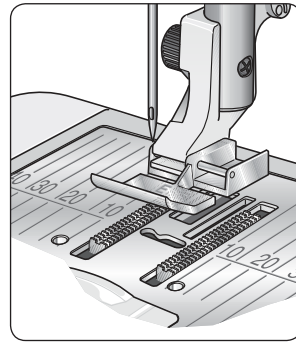

## Center Zipper

1. Sew the two fabrics right sides together along the 5/8" (15mm) seam line, stopping at the notch for the zipper placement.
2. Baste the remaining seam where the zipper will be placed. Press the seam open. Place the zipper right side to the pressed open seam allowance, placing the zipper stop at the notch. Pin the zipper on the right side so it stays in place (see fig. 1).
3. Select straight stitch and move the needle position to the left. Snap on the Zipper Foot E so the needle is on the left side of the foot. Place fabric under the foot right side up with the zipper foot on the right side of the zipper.
4. Begin stitching across the bottom, turn the fabric and stitch the right side of the zipper to the top (see fig. 2).
5. To avoid fabric shifting, sew the left side of the zipper in the same direction. Snap on the Zipper Foot E so the needle is on the right side of the foot. Move the needle position to the right.
6. Begin stitching across the bottom, turn the fabric and stitch the left side of the zipper sewing from the bottom to the top (see fig. 3).
7. Remove the basting stitches.

**NOTE:** To adjust the position of the stitching line, adjust the needle position with the stitch width buttons.

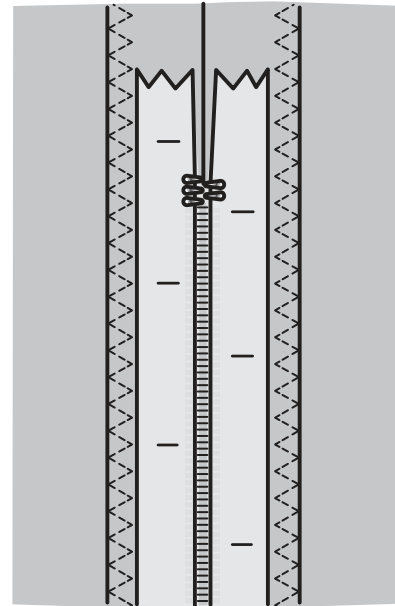

Fig. 1

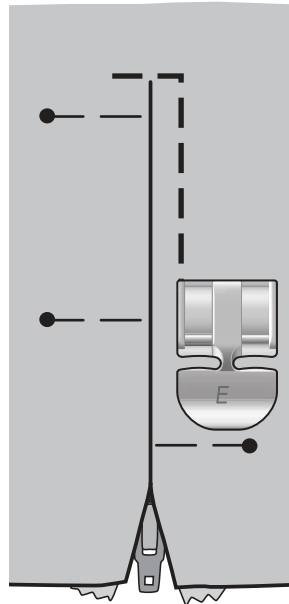

Fig. 2

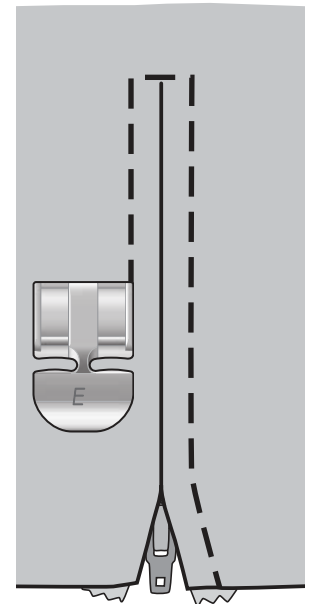

Fig. 3

## Free Motion Quilting

### Free Motion Floating

When sewing free motion at a low speed, the foot will raise and lower with each stitch to hold the fabric on the stitch plate while the stitch is being formed. When sewing at a high speed, the foot floats over the fabric while sewing. The feed teeth must be lowered and the fabric is moved manually.

Most free motion sewing is stitched with a straight stitch or zig zag stitch. However, all stitches can be sewn in free motion mode. The direction and speed with which you move the fabric will determine how the stitch will look.

**NOTE:** Free Motion Spring Action – If you are using the optional Free Motion Spring Action presser foot, set the machine in Free Motion Spring Action mode. The “Drop Feed Teeth” recommendation will be activated. Lower the feed teeth. The setting remains when the machine is turned off. A pop-up message reminds you of the setting when you turn on the machine. Close the pop-up message by pressing OK. For normal sewing, turn off the Free Motion Spring Action mode in the SET menu.

The Free Motion Spring Action presser foot follows the up-and-down movement of the needle with the help of the spring and the arm on the presser foot. The feed teeth must be lowered and the fabric is moved manually.

*Tip: Use the optional Open Toe Free Motion Spring foot.*

### Free Motion Stippling

You will have to move the fabric manually.

1. Select NEEDLE UP/DOWN to put the needle down.
2. Sew at a constant medium speed, moving the fabric randomly. Try drawing squiggles with the needle as you sew. Free motion stippling is usually a random wavy stitching that should be fairly close together but not crossing. The stitching should look like puzzle pieces.

*Tip: Use the optional Open Toe Stippling Foot for better visibility when free motion stippling.*

**NOTE:** To set the machine to regular sewing mode go to SET Menu. Touch OK to deselect Free Motion setting. Touch SET Menu to exit.

#### 1:1 Free Motion Stippling

**Fabric:** Woven medium with batting underneath.

**Select:** Woven medium on The Exclusive SEWING ADVISOR™, Straight Stitch 1, FreeM Floating in the Machine SET menu. Touch OK. Touch SET Menu to return to sewing mode. Lower feed teeth.

**Use:** Presser Foot R and size 80 needle as recommended.

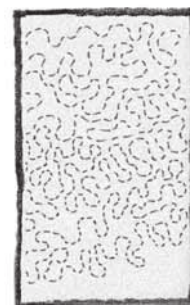

## Decorative Tapering Stitches (Only on 875)

### Quilt)

The Decorative Tapering Stitches can be used to taper the stitch to form corners and points.

1. Select a Decorative Tapering Stitch. The Decorative Tapering Stitches are marked with a blue color in the Stitch panel in the lid.
2. Press the CLR button to open the Tapering view. Use the left and right arrow buttons to select beginning and/or end tapering. Press OK to activate. Select the angle you want for your taper by using the arrow buttons.
3. Press the CLR button to close the Tapering view. Icons will appear on the GraphicDisplay to show you that the beginning and/or end tapering are activated.

**NOTE:** Its important to adjust your settings before starting to sew.

4. Place the fabric under the presser foot.
5. Start sewing. If tapering is activated at both the beginning and at the end, the machine will sew the tapered point and then continue with the stitch in the selected stitch width. A reverse icon is shown on the GraphicDisplay. When the stitch is the length as desired, press the Reverse button to start the end tapering. When the tapering is completed the machine stops automatically.

**NOTE:** In Programming, more than one stitch that can be tapered, you do not need to press reverse to activate end tapering. The end taper will start automatically after the last stitch in the program.

*Tip: For a narrower stitch, adjust the stitch width.*

*Tip: To repeat a tapering stitch the same size, program the desired number of stitches and then add tapering at the beginning and/or end.*

**NOTE:** The Automatic Tapering Stitches 1:30 and 1:31 will automatically taper the stitch. Follow step 4-5 to sew these stitches. To repeat the Automatic Tapering stitch press the STOP button.

### Decorative Tapering Stitches

**Fabric:** All types of fabric.

**Select:** The fabric you are using and the stitch you want to taper. The Decorative Tapering Stitches are marked with a blue color in the Stitch panel in the lid.

**Use:** Presser foot B as recommended and the needle recommended for your fabric.



## More Sewing Techniques

Find instructions for many more sewing techniques on the HUSQVARNA VIKING® Internet web site.

Enter [www.husqvarnaviking.com](http://www.husqvarnaviking.com) and go to Sewing, Sewing Room, Sewing Techniques.

## Changing the light bulbs

Your sewing machine is equipped with two light bulbs. One is placed under the sewing head and one above the free arm. Only use light bulbs of a type as indicated on the front of the machine (24V, 5W). They are available at your authorized HUSQVARNA VIKING® dealer. Change the light bulbs as described below.

 Press the ON/OFF switch to OFF.

- 1 Place the light bulb remover with the deep hole, marked OUT, around the bulb. Do not turn the bulb, just pull it out to remove it.
- 2 When inserting a new light bulb place the remover with the shallow hole, marked IN, around the new bulb. Insert the new bulb by pushing it up.

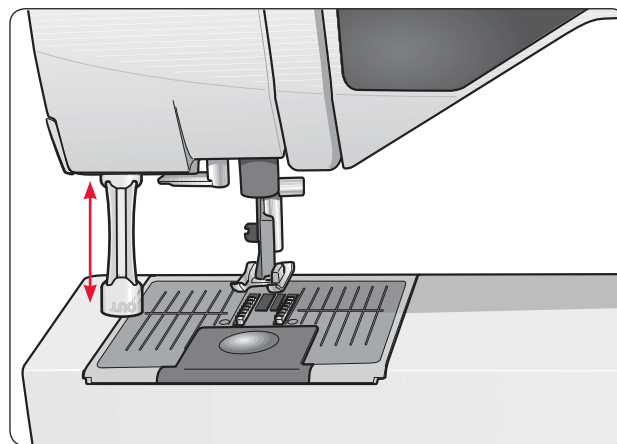

## Cleaning the machine

To keep your sewing machine operating well, clean it often. No lubrication (oiling) is needed.

Wipe the exterior surfaces of your sewing machine with a soft cloth to remove any dust or lint built up.

 Press the ON/OFF switch to OFF.

### Clean the Bobbin Area

Remove the presser foot and slide off the bobbin cover. Lower the feed teeth. Place the screwdriver under the stitchplate as shown on the picture and gently turn the screwdriver to pop off the stitch plate. Clean the feed teeth with the brush.

### Cleaning Under the Bobbin Area

After sewing several projects or any time you notice an accumulation of lint in the bobbin case area, the area under the bobbin case must be cleaned.

Remove the bobbin case holder (1) covering the front part of the bobbin case. Remove the bobbin case (2) by lifting it up. Clean with the brush. A small vacuum attachment works well to remove dust and lint built up.

 On model 875 Quilt: Use caution when cleaning around the thread cut knife (A).

Put the bobbin case and the bobbin case holder back in place.

**NOTE:** Do not blow air into the bobbin case area. The dust and lint will be blown into your machine.

### Replacing the Stitch Plate

With feed teeth lowered, place the stitch plate so that it fits into the notch at the back. Press the stitch plate down until it clicks into place. Slide on bobbin cover.

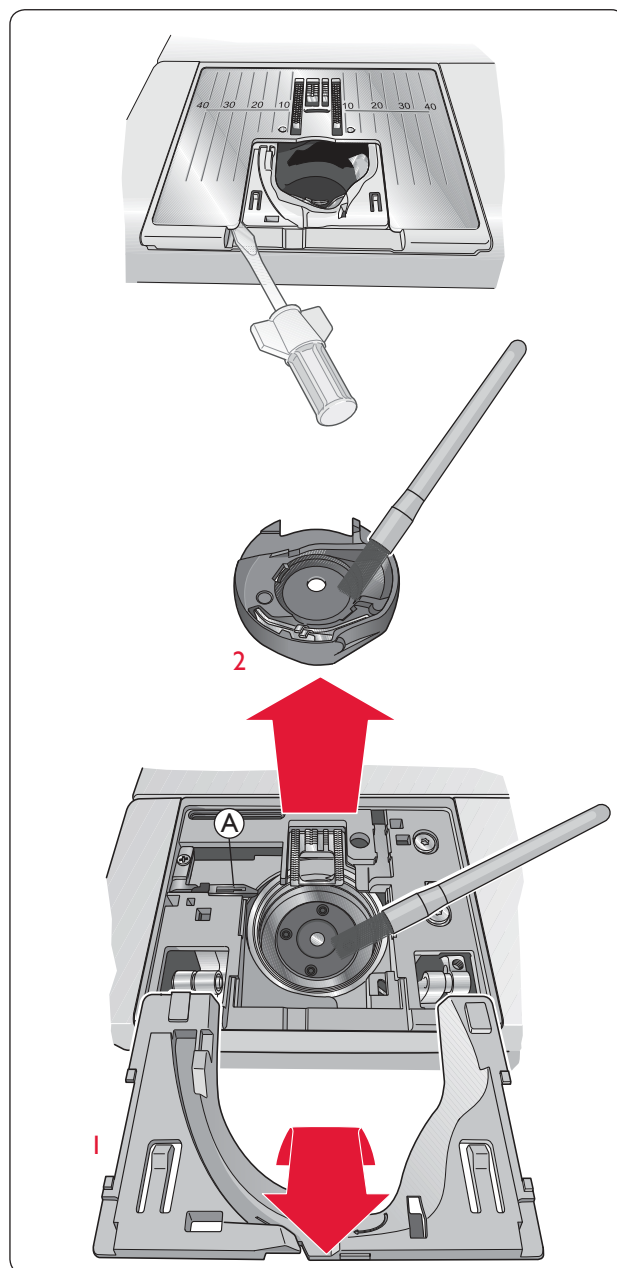

## **Trouble shooting**

### **Any time you experience a problem when sewing:**

- Select correct type and weight of fabric in the Exclusive SEWING ADVISOR™ feature.
- Insert needle size and type as recommended on the GraphicDisplay.
- Rethread the top and bobbin threads.
- Use different spool pin positions (vertical or horizontal).
- Use thread nets and quality thread. We recommend the same sewing thread on top and bobbin for general sewing. For decorative sewing we recommend embroidery thread on top and bobbin thread on bobbin.

### **If you experience problems when sewing the Sensor One-Step Buttonhole:**

- Make sure the white area on the side of the wheel is lined up with the white marking line on the foot.
- Check to insure that the cord to the Sensor One-Step Buttonhole Foot is properly plugged into the socket above the needle area behind the light bulb.

### **Fabric Puckers?**

- Select correct type and weight of fabric in the Exclusive SEWING ADVISOR™ feature.
- Check needle, it could be damaged.
- Insert needle size and type as recommended on the GraphicDisplay.
- Rethread top and bobbin threads.
- Change thread type to match fabric and sewing technique.
- Use quality thread.
- Shorten stitch length.
- Use stabilizer.
- Check your thread tension.

### **Skipped Stitches?**

- Check needle - it could be damaged.
- Change needle to recommended size and type.
- Be sure the needle is inserted correctly all the way into the clamp.
- Rethread top and bobbin threads.
- Use recommended presser foot.
- Turn machine off and on to reset.
- Consult your Authorized HUSQVARNA VIKING® dealer for service.

### **Needle Breaks?**

- Use care not to pull fabric when sewing.
- Insert needle size and type as recommended on the GraphicDisplay.
- Insert needle correctly as described in the User's Guide.

### **Poor Tension?**

- Select correct type and weight of fabric in the Exclusive SEWING ADVISOR™ feature.
- Rethread top and bobbin - use quality thread.
- Insert needle size and type as recommended on the GraphicDisplay.
- Follow recommendations for thread tension.
- Follow recommendations for stabilizer.

### **Upper Thread Breaks?**

- Does thread feed smoothly/not catching?
- Use thread nets and quality thread. For special threads such as metallic etc. please consult your Accessory User's Guide for special needle recommendations.
- Rethread top and bobbin threads - check for correct threading. When using embroidery thread on top, you should use bobbin thread in the bobbin, not regular sewing thread.
- Try different spool pin positions (horizontal or vertical).
- If stitch plate hole is damaged, replace stitch plate.
- Is the correct spool cap used in front of the thread?

### **Fabric Does Not Move?**

- Check to make sure feed teeth are up.
- Increase stitch length.

### **Bobbin Thread Breaks?**

- Wind a new bobbin.
- Replace the bobbin in the machine, check correct threading.
- If stitch plate hole is damaged - replace stitch plate.
- Clean bobbin area.

### **Bobbin Winds Irregularly?**

- Check threading for bobbin winding.

### **Wrong Stitch, Irregular or Narrow Stitches?**

- Turn machine off and on to reset.
- Change needle, rethread top and bobbin threads.
- Use stabilizer.

### **Machine Sews Slowly?**

- Check speed.
- Remove stitch plate and brush lint from bobbin and teeth area.
- Have your sewing machine serviced at your authorized HUSQVARNA VIKING® dealer.

### **Machine Will Not Sew?**

- Put bobbin winder spindle to the left into sewing position.
- Check plugs are securely plugged all the way into the machine.
- Check wall plug and power to wall plug.
- Check foot control connection.

### **The sewing machine function buttons do not respond to touch?**

- The sockets and function buttons on the machine can be sensitive to static electricity. If the function buttons do not respond to touch, turn the machine off and then on again. If the problem persists, contact your authorized HUSQVARNA VIKING® dealer.







### **Have your sewing machine serviced regularly by your authorized HUSQVARNA VIKING® Dealer!**



















If you have followed this trouble shooting information and still have sewing problems, take the sewing machine to your authorized HUSQVARNA VIKING® dealer. If there is a specific problem, it is a great help to test sew with your thread on a scrap of your sewing fabric and bring it to your Authorized HUSQVARNA VIKING® dealer. A sewing sample will often give much better information than words.





### **Non-Original Parts and Accessories**

The warranty does not cover any defect or damage caused by use of non-original accessories or parts.

## Stitch table - menu I. Utility Stitches

Stitch	Stitch no.			Stitch name	Presser Foot	Application
	835	855	875			
	0	0	0	Bartack Buttonhole	Sensor One-Step Buttonh. Foot/C	Standard buttonhole for most fabric weights.
	1	1	1	Straight Stitch, center needle position	A/B	For all types of sewing. Select 29 different needle positions.
	2	2	2	Stretch Stitch, left needle position	A/B	For seams in tricot and stretch fabric.
	3	3	3	Reinforced Straight Stitch, center needle position	A/B	For seams which are subject to considerable strain. Triple and elastic for reinforced seams. Use to reinforce and topstitch sportswear and working clothes. For topstitch, increase the stitch length. 29 needle positions.
	4	4	4	Three-Step Zigzag	A/B	For mending, sewing on patches and elastics. Suitable for light and medium weight fabric. For overcasting, select stitch 1:13.
	5	5	5	Zigzag	A/B	For appliqué work, lace edging, sewing on bands etc. Stitch width increases equally to the left and right.
	6	6	6	Flatlock Stitch	B	Decorative hems and overlapped seams, belts and bands. For medium/heavy stretch fabrics.
	7	7	7	Overcast Stitch	J	Seam and overcast in one step along the edge or trim later. For light stretch and non-stretch fabrics.
	8	8	8	Stretch Seam Overcast Stitch	B	Seam and overcast in one step along the edge or trim later. For medium and medium/heavy stretch fabrics.
	9	9	9	Automatic Button Sewing	No presser foot	For sewing on buttons. Set the number of stitches on the GraphicDisplay.
	10	10	10	Double Overlock Stitch	B	Seam and overcast in one step along the edge or trim later. For heavy stretch and heavy woven fabrics.
	11	11	11	Overlock Stitch	B	Seam and overcast in one step along the edge or trim later. For medium stretch fabrics.
	12	12	12	Elastic/Casing Stitch	B	For overlapped seams in tricot. To sew casing over narrow elastic.
	13	13	13	Three-step Zigzag Overcast	J/B	For overcasting in all kinds of fabric
	14	14	14	Reinforced Zigzag	B	For joining fabric edge to edge or overlapping in leather. For decorative sewing.
	15	15	15	Baste Stitch	A/B	For joining two pieces of fabric with a long stitch length (reduce thread tension according to recommendations on the GraphicDisplay).
	16	16	16	Stretch Blind Hem Stitch	D	Blind hems in medium and heavy stretch fabrics.
	17	17	17	Woven Blind Hem	D	Blind hems in medium and heavy woven fabrics.
	18	18	18	Shell Edge	A/B	For edgings, sew over the edge on light stretch fabrics, sew woven fabrics on bias.

Stitch	Stitch no.			Stitch name	Presser Foot	Application
	835	855	875			
	19	19	19	Elastic Stitch or Smocking	A/B	Sew over two rows of elastic thread for elastic shirring.
	20	20	20	Bridging stitch	A/B	For joining two pieces of fabric with finished edges and for elastic shirring.
	21	21	21	Darning Stitch (forward and backward)	A/B	Darn and mend small holes in work clothes, jeans, tablecloths and more. Stitch over the hole, press reverse for continuous darning and auto stop.
	22	22	22	Bartack (manual)	A/B	Reinforce pockets, shirts openings, belt loops as well as at lower end of a zipper.
	23	23	23	Round End Buttonhole	Sensor One-Step Buttonh. Foot/C	For blouses and children's garments.
	24	24	24	Medium Reinforced Buttonhole	C	For medium and heavy fabrics.
	25	25	25	Heirloom Buttonhole	Sensor One-Step Buttonh. Foot/C	For "hand look" on fine and delicate fabrics. Tip: For jeans buttonholes, increase length and width of the buttonhole. Use thicker thread.
	26	26	26	Keyhole Buttonhole	Sensor One-Step Buttonh. Foot/C	For tailored jackets, coats, etc.
	27	27	27	Heavy Duty Buttonhole	Sensor One-Step Buttonh. Foot/C	With reinforced bartacks.
	28	28	28	Leather Straight Stitch Buttonhole	A/B	For leather and suede.
	29	29	29	Eyelet	B	For belts, laces, etc.
	-	-	30	Automatic Tapering Stitch	B	Begins and ends with a point. Used for corners, points and satin stitch lettering. Press reverse to taper.
	-	-	31	Automatic Tapering Stitch	B	Begins and ends with a point. Used for corners, points and satin stitch lettering. Press reverse to taper.
	30	30	32	Satin stitch, narrow	B	For appliqués, sewing on laces and trims. For light and medium fabrics.
	31	31	33	Satin stitch, medium	B	For appliqués, sewing on laces and trims. For light and medium fabrics.
	32	32	34	Satin stitch, wide	B	For appliqués, sewing on laces and trims. For heavy fabrics.
	-	33	35	Scallop Wave	B	For edge finishing. Trim away fabric outside scallops.
	33	34	36	Narrow Rick Rack Stitch	B	For edge finishing. Trim away fabric outside scallops.
	34	35	37	Scallop Stitch	B	For edge finishing. Trim away fabric outside scallops.

Stitch	Stitch no.			Stitch name	Presser Foot	Application
	835	855	875			
	-	36	38	Scallop Stitch	B	For edge finishing. Trim away fabric outside scallops.
	35	37	39	Satin Arrow Head	B	For edge finishing. Trim away fabric outside scallops.
	-	-	40	Mushroom	B	For edge finishing. Trim away fabric outside scallops.
	-	38	41	Two-Step Zigzag	A/B	For joining two pieces of fabric with finished edges and for elastic shirring.
	-	39	42	Straight stitch with FIX	A/B	Begins and ends with forward and reverse sewing.

## Stitch overview

Menu 1: Utility Stitches, Menu 2: Quilt Stitches,  
Menu 3: Satin and Heirloom Stitches, Menu 4: Decorative Stitches

Stitches 0-9 are the same in all four stitch menus.

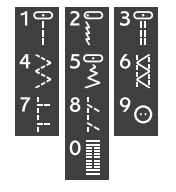

### SAPPHIRE™ 835

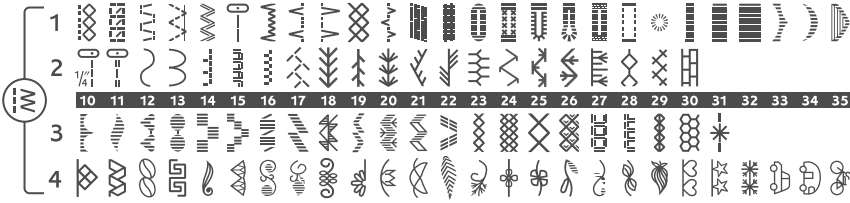

### SAPPHIRE™ 855

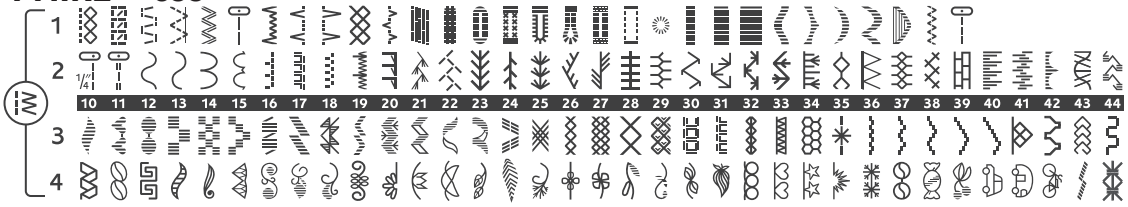

### SAPPHIRE™ 875 Quilt



The stitches marked with a red box can be used for tapering.

## Alphabets

### Block (835/855/875 Quilt)

A B C D E F G H I J K L M N O P Q R S T U U V W X Y Z Å Ä Ö - , . \_  
a b c d e f g h i j k l m n o p q r s t u ü v w x y z å ä ö @ , . \_  
1 2 3 4 5 6 7 8 9 0 Æ æ Ø ø à á ç è é ê í ó ù ú Ñ ñ ß & ? ! ' . \_

### Brush Line (855/875 Quilt)

A B C D E F G H I J K L M N O P Q R S T U U V W X Y Z Å Ä Ö - , . \_  
a b c d e f g h i j k l m n o p q r s t u ü v w x y z å ä ö @ , . \_  
1 2 3 4 5 6 7 8 9 0 Æ æ Ø ø à á ç è é ê í ó ù ú Ñ ñ ß & ? ! ' . \_

### Script (875 Quilt)

A B C D E F G H I J K L M N O P Q R S T U U V W X Y Z Å Ä Ö - , . \_  
a b c d e f g h i j k l m n o p q r s t u ü v w x y z å ä ö @ , . \_  
1 2 3 4 5 6 7 8 9 0 Æ æ Ø ø à á ç è é ê í ó ù ú Ñ ñ ß & ? ! ' . \_

### Cyrillic and Hiragana

Russian and Japanese alphabets. See the fonts on the GraphicDisplay of your sewing machine.



## Intellectual property

Patents protecting this product are listed on a label positioned underneath the sewing machine.

VIKING, KEEPING THE WORLD SEWING & Design, SAPPHIRE, EXCLUSIVE SENSOR SYSTEM and SEWING ADVISOR are trademarks of KSIN Luxembourg II, S.ar.l. HUSQVARNA and the “crowned H-mark” are trademarks of Husqvarna AB.

All trademarks are used under license by VSM Group AB.

We reserve the right to change the machine equipment and the assortment of accessories without prior notice, or make modifications to the performance or design.

Such modifications, however, will always be to the benefit of the user and the product.



Please note that on disposal, this product must be safely recycled in accordance with relevant National legislation relating to electrical/ electronic products. If in doubt please contact your retailer for guidance.

