

User's Guide

Designer Epic™ | 3

IMPORTANT SAFETY INSTRUCTIONS

Read all instructions before using this sewing machine.

When using an electrical appliance, basic safety precautions should always be followed, including the following:

Keep the instructions at a suitable place close to the machine. Make sure to hand them over if the machine is given to a third party.

This appliance is intended for use by adults. The appliance can be used with adult supervision by (i) children aged from 8 to 12 years and (ii) persons with reduced physical, sensory or mental capabilities or lack of experience and knowledge if they have been given instruction concerning use of the appliance in a safe way and understand the hazards involved. Cleaning and user maintenance shall not be made by children without supervision. It is not allowed for anyone to play with the machine. Children up to 8 years are not allowed to use the machine.

DANGER - TO REDUCE THE RISK OF ELECTRIC SHOCK:

- A sewing machine should never be left unattended when plugged in. The electrical socket, to which the machine is plugged in should be easily accessible. Always unplug this sewing machine from the electric outlet immediately after using and before cleaning, removing covers, lubricating or when making any other user servicing adjustments mentioned in the instruction manual.

WARNING –TO REDUCE THE RISK OF BURNS, FIRE, ELECTRIC SHOCK, OR INJURY TO PERSON:

- Do not allow to be used as a toy. Close attention is necessary when this sewing machine is used by or near children.
- Use this sewing machine only for its intended use as described in this manual. Use only attachments recommended by the manufacturer as contained in this manual.
- Never operate this sewing machine if it has a damaged cord or plug, if it is not working properly, if it has been dropped or damaged, or dropped into water. Return the sewing machine to the nearest authorized dealer or service center for examination, repair, electrical or mechanical adjustment.
- Never operate the sewing machine with any air openings blocked. Keep ventilation openings of the sewing machine and foot control free from the accumulation of lint, dust, and loose cloth.
- Keep fingers away from all moving parts. Special care is required around the sewing machine needle.
- Always use the proper needle plate. The wrong plate can cause the needle to break.
- Do not use bent needles.
- Do not pull or push fabric while stitching. It may deflect the needle causing it to break.
- Wear safety glasses.
- Turn the sewing machine off when making any adjustment in the needle area, such as threading needle, changing needle, threading bobbin, or changing presser foot, etc.
- Never drop or insert any object into any opening.
- Do not use outdoors.

- Do not operate where aerosol (spray) products are being used or where oxygen is being administered.
- To disconnect, turn the power off, then remove the plug from the outlet.
- Do not unplug by pulling the cord. To unplug, grasp the plug, not the cord.
- The foot control is used to operate the machine. Never place other objects on the foot control.
- Do not use the machine if it is wet.
- If the LED lamp is damaged or broken, it must be replaced by the manufacturer or its service agent or a similarly qualified person, in order to avoid a hazard.
- Only use the power supply unit and cord supplied with your machine. No other cord can be used. If the cord is damaged or lost, make sure to replace it with the same type of cord, available at an authorized HUSQVARNA® VIKING® Dealer.
- If the cord connected with the foot control is damaged, it must be replaced by the manufacturer or its service agent or a similarly qualified person, in order to avoid a hazard.

For Overlock Machines only:

- Never operate without a cutter cover or a securely installed coverstitch table.

SAVE THESE INSTRUCTIONS

Federal Communication Commission Interference Statement

For the USA and Canada

Responsible party: Singer Sourcing Limited LLC
1714 Heil Quaker Boulevard, Suite 130, LaVergne, TN 37086

Product name: HUSQVARNA® VIKING® DESIGNER EPIC™ 3 sewing machine

This device complies with Part 15 of the FCC Rules. Operation is subject to the following two conditions: (1) This device may not cause harmful interference, and (2) this device must accept any interference received, including interference that may cause undesired operation.

To satisfy radio frequency exposure requirements, a separation distance of 8” (20 cm) or more should be maintained between this device and persons during device operation. To ensure compliance, operations at closer than this distance is not recommended. The built-in antenna used for this transmitter must not be co-located in conjunction with any other antenna or transmitter.

This equipment has been tested and found to comply with the limits for a Class B digital device, pursuant to Part 15 of the FCC Rules. These limits are designed to provide reasonable protection against harmful interference in a residential installation. This equipment generates, uses and can radiate radio frequency energy and, if not installed and used in accordance with the instructions, may cause harmful interference to radio communications. However, there is no guarantee that interference will not occur in a particular installation. If this equipment does cause harmful interference to radio or television reception, which can be determined by turning the equipment off and on, the user is encouraged to try to correct the interference by one of the following measures:

- Reorient or relocate the receiving antenna.
- Increase the separation between the equipment and receiver.
- Connect the equipment into an outlet on a circuit different from that to which the receiver is connected.
- Consult the authorized HUSQVARNA® VIKING® retailer or an experienced radio/TV technician for help.

The included interface cable should be used in order to ensure compliance with the limits for a Class B digital device.

 *Any changes or modifications not expressly approved by the party responsible for compliance could void the user's authority to operate this equipment.*

CE Declaration of Conformity

VSM Group AB Soldattorpsgatan 3, SE-554 74 Jonkoping, Sweden declare that the product:

Household Sewing Machine HUSQVARNA® VIKING® DESIGNER EPIC™ 3 complies fully with following EU directives:

- 2014/53/EU RED Directive

and that the relevant harmonized standards are applied as listed:

- EN 60335-1:2012, A13:2017, A1:2019, A2:2019, A14:2019, A15:2021
- EN 60335-2-28:2003, A1:2008, A11:2018
- EN 62233:2008
- EN 50014-1:2021
- EN 55014-2:2021
- EN 61000-3-2:2019, A1:2021
- EN 61000-3-3:2019, A1:2019
- EN 63000
- EN 301 489-17 V3.2.0
- EN 301 489-1 V3.2.3
- EN 300 328 V2.2.2

Jönköping, January 2023

Carsten Raunsgaard

Manager Regulatory Compliance

TABLE OF CONTENTS

I	Introduction	11	Attaching the Sensor One-Step Buttonhole Foot.....	44	
	Learn More.....	12	Attaching the Sensor Q-Foot.....	44	
	Machine Overview	12	Changing the Needle Plate	45	
	Front	12	Storing a Needle Plate.....	45	
	Needle Area	13	Getting Started with WiFi and mySewnet Cloud	46	
	Left Side.....	13			
	Right Side	13			
	Rear.....	13			
	Accessory Tray	14			
	Function Buttons	15			
	Accessories.....	17	3	Embroidery Preparations	47
	Included Accessories	17		Embroidery Unit Overview	48
	Included Accessories Not in Picture	17		Embroidery Unit Extension Overview	48
	Included Hoops.....	17		Large Hoop Support Overview.....	48
	Presser Feet.....	18		Embroidery Hoop Overview.....	48
	Stitch Overview.....	20		Sensor Q-Foot.....	49
	Utility Stitches 1, Basic Stitches.....	20		Straight Stitch Plate.....	49
	Utility Stitches 2, Appliqué & Mending	21		Embroidery Designs	49
	Utility Stitches 3, Buttonholes.....	22		Connecting the Embroidery Unit.....	50
	Stitch Menu Overview	24		Removing the Embroidery Unit.....	51
	Alphabets	24		Using the Embroidery Unit Extension and Large Hoop Support	51
2	Preparations	25		Attach the Embroidery Unit Extension.....	51
	Unpacking Machine and Embroidery Unit.....	26		Attach the Large Hoop Support.....	52
	Connecting the Power Cord and Foot			Removing the Embroidery Unit Extension and Large Hoop Support.....	52
	Control.....	26		Hooping the Fabric	53
	Packing Away After Sewing.....	27		Attaching and Removing the Hoop.....	54
	USB Ports.....	27		Using the Hoop Adapter	54
	Using a USB Device	27	4	The Multi-Touch Screen	55
	LED Lights	27		Main Functions.....	56
	Free Arm.....	27		Home	56
	Manual Thread Cutter	28		Save.....	56
	Thread Sensor	28		Mode Switch	56
	Speed Control Slider	28		Quick Help	57
	Telescopic Thread Guide	28		Common Functions.....	57
	Spool Pins.....	29		Top Bar	58
	Spool Caps.....	29		Secondary Top Bar	58
	Threads	29		Recommendations.....	58
	Needles.....	31		Information	58
	Important Needle Information	31		Active Features	58
	Changing the Needle.....	32	5	WiFi & mySewnet Services	59
	Threading	33		WiFi Introduction	60
	Threading the Upper Thread.....	33		Getting Started With WiFi	60
	Automatic Needle Threader.....	35		Firmware Updates	60
	Threading for Twin Needle.....	37		Firmware Update Using WiFi.....	60
	Threading Tips and Hints.....	39		Firmware Update Using a USB Device	61
	Bobbin Winding.....	40		mySewnet Services.....	61
	Winding Through the Needle.....	41		mySewnet Cloud.....	61
	Inserting the Bobbin.....	42		mySewnet Library	61
	Integrated Dual Feed (IDF) System	43		mySewnet Blog.....	61
	Engaging the IDF System.....	43		Project Creator	62
	Disengaging the IDF System.....	43			
	Changing the Presser Foot.....	43			

Free mySewnet Embroidery Software (PC and MAC).....	62	Seam and Overcast.....	83
Apps.....	62	Baste.....	83
6 Home Screen.....	63	Blind Hem.....	84
Home Screen— Overview.....	64	Hem.....	84
Edit Machine Nickname.....	65	Buttonholes.....	85
User Profile.....	65	Programmable Button Sew On.....	86
Sewing/Embroidery — Start New Session.....	65	Tapering Stitches.....	86
Continue from Saved State.....	65	4-Way Stitches.....	87
mySewnet™ Blog.....	65	8-Way Stitches.....	87
User's Guide.....	65	Special Stitches For Optional Presser Feet.....	87
JoyOS ADVISOR™.....	66	Exclusive Sewing Techniques.....	87
Sewing.....	67	Motif Builder Stitches.....	87
Quilting.....	68	Dimensional Stitches.....	87
Embroidery.....	68	Theme Stitches.....	88
Get Started.....	68	Embellished Stitches.....	89
Advanced Features.....	68	Floating Stitches.....	89
Accessories.....	68	Guided Pictograms.....	89
Needles.....	68	Pop-up Messages in Sewing.....	89
Stabilizers.....	69	8 Stitch Creator™ Feature.....	91
Project Viewer.....	70	Stitch Creator™ Feature – Overview.....	92
7 Sewing.....	71	Getting Started with Stitch Creator™.....	93
Sewing Mode – Overview.....	72	Definition of a Stitch Point.....	93
Load a Stitch.....	73	Select Stitches/Stitch Points.....	93
Projection — Overview.....	73	Preview.....	93
Projection Options.....	74	Edit Stitch in Stitch Creator™.....	94
Stitch Preview.....	74	Zoom Options.....	94
Grid.....	75	Move.....	94
Stitch Guidelines.....	75	Duplicate Selected Stitch Point.....	94
Information and Sewing.....	76	Delete Selected Stitch Point.....	94
Recommendations.....	76	Mirroring.....	94
Presser Foot Recognition.....	76	Triple Stitch.....	94
Stitch Settings.....	76	Add a Stitch or Stitch Point.....	95
Stitch Width.....	77	Pop-up Messages in Stitch Creator™ Feature.....	95
Stitch Positioning.....	77	9 Embroidery Edit.....	97
Stitch Length.....	77	Embroidery Edit — Overview.....	98
Stitch Density.....	77	Load a Design.....	99
Mirroring.....	77	mySewnet Library.....	99
Buttonhole Slit Length.....	77	Load a Font.....	99
Button Stitch Repetition.....	78	Load a Stitch.....	100
deLuxe™ Stitch System.....	78	Load Saved Files.....	100
Presser Foot Pressure.....	79	Color Edit.....	101
Balance.....	79	Change Color.....	102
Free Motion Options.....	79	Layers.....	102
Tie-Off Options.....	80	Select Designs/Change Stitch-Out Order.....	103
Save Stitch.....	81	Select All.....	103
Sewing Programs.....	81	Select Multiple.....	103
Stitch Repeat.....	81	Group/Ungroup.....	103
Patchwork Program.....	82	Edit Functions.....	103
Single Stitch Program.....	82	Move.....	104
Combining Programs.....	82	Rotate.....	104
Sewing Techniques.....	83	Scale.....	104
Seam.....	83	Duplicate/Multi Duplicate.....	104
Overcast.....	83	Delete/Delete All.....	105

Mirroring.....	105	Center Position.....	125
Move into Hoop.....	105	Exact Position.....	126
Undo/Redo.....	105	Zoom Options.....	126
Pan.....	105	Set Cursor Point.....	126
Zoom Options.....	106	Exact Position Exercise.....	126
Hoop Options.....	106	Projection in Embroidery Stitch-Out.....	127
Select Hoop.....	106	Save Current State/Restore Current	
Scan Hoop.....	107	State.....	128
Background.....	107	Auto Save.....	128
Grid Options.....	107	Pop-up Messages in Embroidery Stitch-	
Alignment.....	107	Out.....	129
Background Color.....	107		
mySewnet Send Design.....	107	11 Sequence.....	131
Edit Stitch.....	108	Sequence – Overview.....	132
Resize.....	108	Getting Started with Sequence.....	133
Resize Adjustments.....	108	Directional Stitches.....	133
Embroidery Text.....	110	Edit and Adjust Your Sequence.....	134
Create a Text.....	110	Sequence Commands.....	134
Add a Letter.....	110	Saving a Sequence.....	135
Delete a Letter.....	110	Sew or Embroider Your Sequence.....	135
Text Shaping.....	110	Adjust the Entire Sequence.....	135
Create Shape.....	112	Using Sequence in Sewing Mode and	
Set Number of Designs/Stitches.....	113	Embroidery Edit.....	135
Create Appliqué.....	114	Pop-up Messages in Sequence.....	135
Load Autofill Stitch.....	115		
Positioning in Create Shape/Create		12 Settings.....	137
Appliqué.....	115	Sewing Settings.....	138
Select Spacing.....	115	<i>deLuxe</i> [™] Stitch System.....	138
Select Line Positioning.....	115	Automatic Presser Foot Lift.....	138
Select Side Positioning.....	115	Automatic Thread Cutter.....	138
Fixed Design Angle.....	116	Free-Motion Options.....	138
Control Points.....	116	Stitch Limiting Options.....	139
Save Design.....	116	Needle Stop Position.....	139
Pop-up Messages in Embroidery Edit.....	116	Presser Foot Pressure.....	139
		Options for Feed Teeth.....	139
		Tie-Off Options.....	139
		Embroidery Settings.....	140
10 Embroidery Stitch-Out.....	119	<i>deLuxe</i> [™] Stitch System.....	140
Embroidery Stitch-Out – Overview.....	120	Embroidery Foot Type.....	140
Review the Embroidery Stitch-Out Settings.....	121	Twin Needle Options.....	140
Color Block List.....	123	Thread Cut Options.....	141
Basting Options.....	123	Presser Foot Height Embroidery.....	141
Ghost Mode.....	123	Select Default Hoop Size.....	141
Color Block Sort.....	123	Review Embroidery Settings.....	141
Color Block Merge.....	123	Display & Audio Settings.....	142
One Color.....	124	Language.....	142
Stitch-Out Progress.....	124	Time Format.....	142
Remaining Embroidery Time.....	124	Time Zone.....	142
Number of Stitches in Embroidery		Audio Volume.....	142
Combination.....	124	Audio Repeat.....	142
Step Stitch-by-Stitch / Go to Stitch.....	124	LED Work Light Brightness.....	142
Corner Check.....	124	Units.....	142
<i>deLuxe</i> [™] Stitch System.....	125	Personalize Settings.....	143
Zoom Options.....	125	Machine Nickname.....	143
Hoop Position.....	125	Color Themes.....	143
Current Stitch Position.....	125	Bottom Bar Text.....	143
Park Position.....	125		
Trim Position.....	125		

Customize Your Workspace	143
Lock Screen	143
Show Demo Mode	143
Play Feature Videos as Screensaver.....	143
WiFi Settings.....	144
mySewnet Settings.....	145
Camera and Projection Settings.....	146
Presser Foot Recognition.....	146
Adjust Camera.....	146
Adjust Projection	146
Machine Information.....	147

13 File Manager 149

File Manager – Overview.....	150
File Formats	151
Browse File Manager.....	151
Open a File or Folder.....	151
Select Multiple	151
mySewnet Folder.....	151
USB Device	152
List/Thumbnail View	152
Move up One Folder Level	152
Organize.....	152
Create New Folder	152
Rename a File or Folder	152
Move a File or Folder.....	153
Copy a File or Folder	153
Delete a File or Folder	153
Pop-up Messages in File Manager.....	154

14 Maintenance 155

Cleaning the Machine Exterior.....	156
Removing the Needle Plate and Cleaning the Bobbin Area	156
Cleaning Under the Bobbin Area.....	156
Replacing the Needle Plate.....	156
Troubleshooting.....	157
Service	161
Non-Original Parts and Accessories	161
Technical Specification	161

Index 163

I Introduction



Learn More

Machine Overview

Front

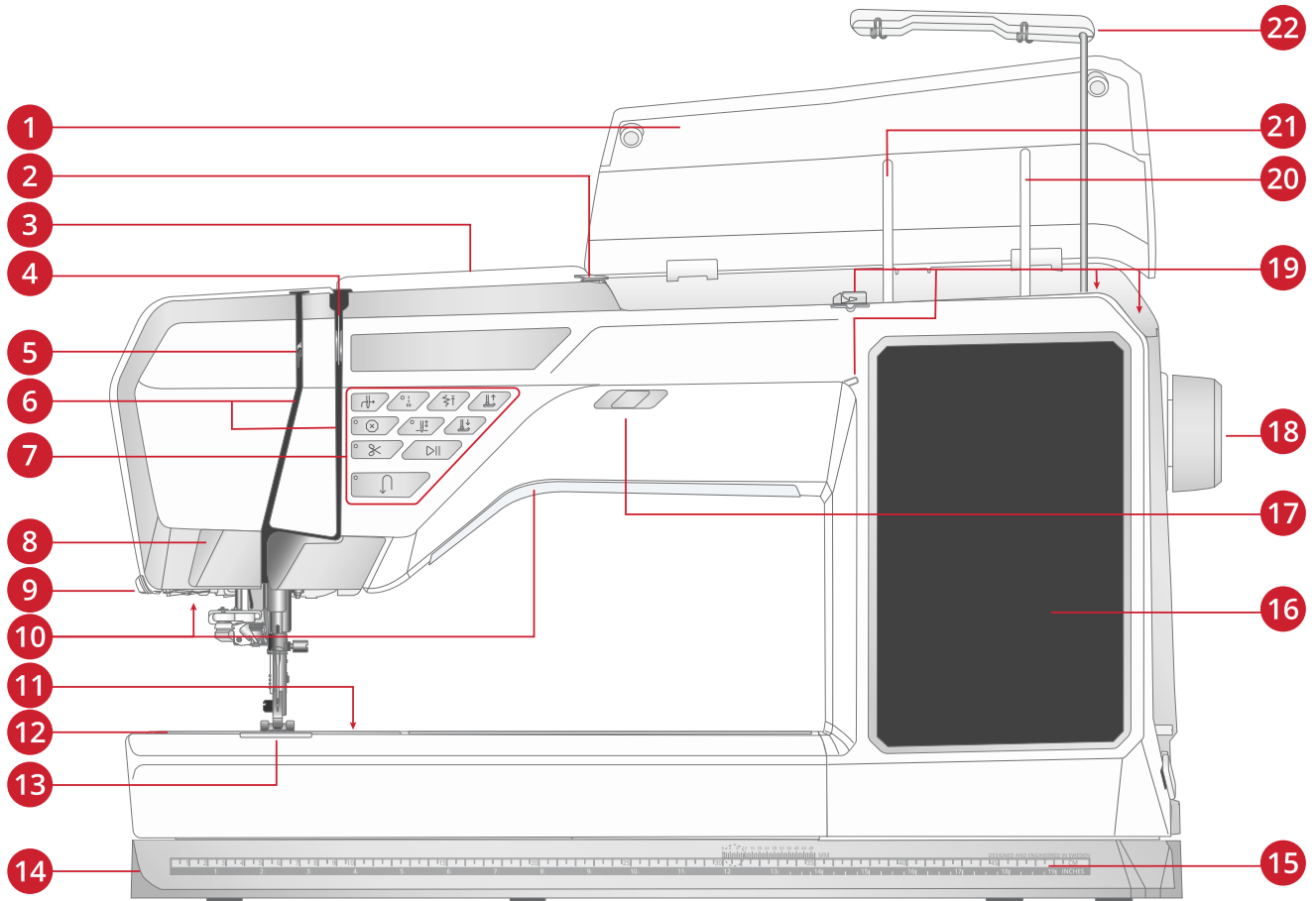

- | | | |
|-----------------------------|---------------------------------|----------------------------------|
| 1. Lid | 9. Thread cutter | 17. Speed control slider |
| 2. Pre-tension thread guide | 10. LED lights | 18. Hand wheel |
| 3. Threading slot | 11. Bobbin cover release button | 19. Bobbin winding thread guides |
| 4. Thread tension discs | 12. Needle plate | 20. Auxiliary spool pin |
| 5. Thread take-up lever | 13. Bobbin cover | 21. Main spool pin |
| 6. Threading slots | 14. Base plate | 22. Telescopic thread guide |
| 7. Function buttons | 15. Ruler with button ruler | |
| 8. Projector / Camera | 16. Multi-touch screen | |

Needle Area

1. Automatic needle threader
2. Needle holder with needle clamp screw
3. Needle thread guide
4. Integrated Dual Feed (IDF) System
5. Presser foot
6. Presser foot ankle
7. Presser foot bar

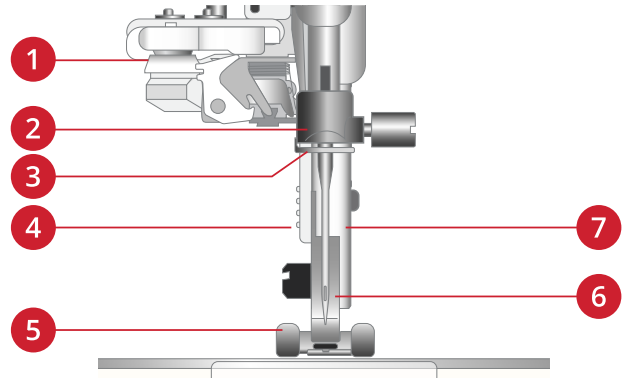

Left Side

1. Integrated Dual Feed (IDF) System
2. Slots/grooves to attach embroidery unit extension and/or extension table
3. Free arm
4. Embroidery unit connector

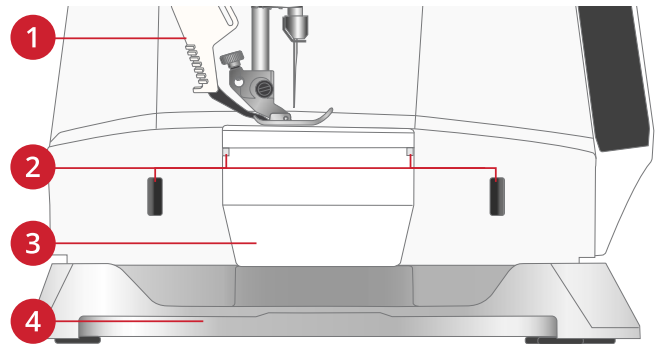

Right Side

1. Bobbin winder
2. Bobbin winding lever
3. Thread cutter for bobbin winding
4. Foot control socket
5. Power button and power symbol
6. Power cord socket
7. USB ports
8. Speaker

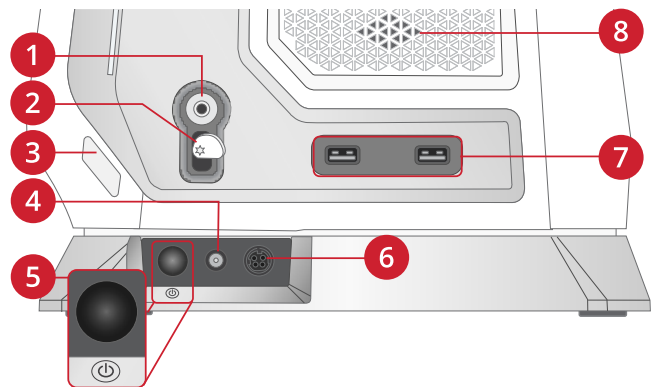

Rear

1. Notches (placed under the handle) used for optional accessories such as Eight Thread Spool Rack and/or Yarn Couching Feet Set
2. Slot to attach embroidery unit extension and/or extension table
3. Handle
4. Accessory socket
5. Groove to attach embroidery unit extension and/or extension table
6. Free arm

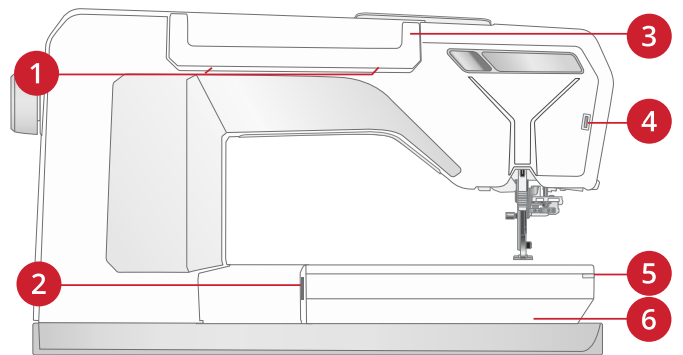

Accessory Tray

The accessory tray features special compartments for presser feet and bobbins, plus space for needles and other accessories. Store the accessories in the tray so they are easily accessible.

1. Space for accessories
2. Hook for storing the Sensor One-Step Buttonhole Foot
3. Space for needle plate
4. Space with hole for Buttonhole Foot C
5. Spaces for presser feet
6. Removable bobbin holder
7. Slot for needle packs
8. Space for seam ripper and brush
9. Extra wide space for Side-Motion Foot S

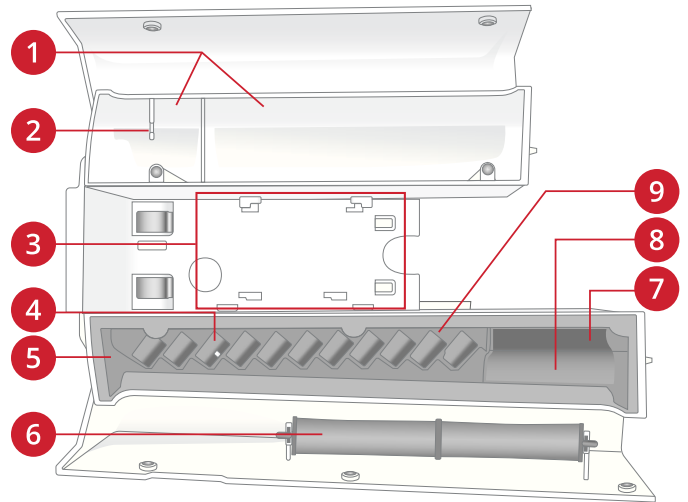

Function Buttons

1. Stop
2. Cut
3. Reverse
4. Start/Stop
5. Presser foot down and pivot
6. Needle stop up/down
7. Presser foot up and extra lift
8. Stitch restart
9. Immediate tie-off
10. Automatic needle threader

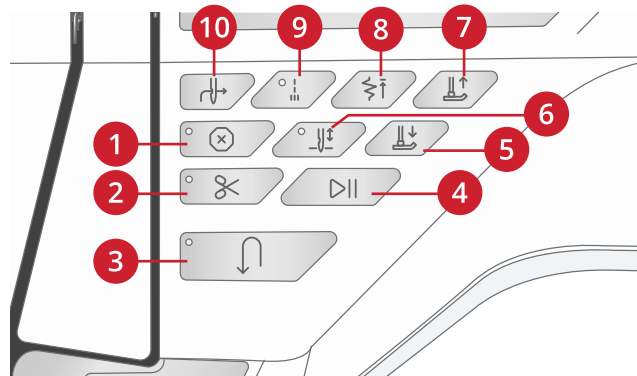

Stop

Press the stop button when sewing to conclude a stitch or stitch program. Your machine fixes the thread and stops automatically when the stitch or stitch program has been completed. Press stop before starting to sew and your machine sews only one repetition of the stitch. Only one stitch is displayed on the screen. The indicator next to the stop button is lit when the stop function is active. To cancel the function, press stop again or select a new stitch. The stop function is cancelled when the stitch is completed.

The stop function is also used to repeat a sewn length when sewing tapering, (see Tapering Stitches) and when sewing manual buttonholes.



Cut

Press the cut button and your machine cuts the upper and bobbin threads and raises the presser foot and needle.

To cut threads at the end of a stitch or stitch sequence, press the cut button while sewing. The indicator light will illuminate, alerting you that a cut is requested. When the stitch or stitch sequence is completed, your machine cuts the upper and bobbin threads and raises the presser foot and needle.

Note: If automatic presser foot lift has been deselected in settings the presser foot will not be raised when using the cut function.

Press cut when embroidering and your machine cuts the upper and bobbin threads instantly.

Note: Some optional accessories are attached in the two small circular holes in the needle plate just above the bobbin cover. Do not use the cut function when an accessory is attached in these holes as that may interfere with the automatic thread cutter located under the needle plate



Reverse

When reverse is active, the reverse indicator is lit. For permanent reverse, press the reverse button once before starting to sew. The reverse indicator is lit and the machine sews in reverse until you press the button again to cancel. If you press the reverse button while sewing, the machine will sew in reverse for as long as you keep the button pressed.

Reverse is also used when sewing manual buttonholes, darning stitches and tapering stitches to step between the parts of the stitch.



Start/Stop

Press the start/stop button to start and stop the machine when sewing or embroidering without using the foot control. Press start/stop to begin and press again to stop.



Presser Foot Down and Pivot

The presser foot is lowered automatically when you start sewing. To lower the presser foot before starting to sew, press the presser foot down and pivot button. The presser foot will be completely lowered and the machine firmly holds the fabric. Press presser foot down again to go to pivot position (the presser foot is raised just enough to pivot the fabric).

In embroidery mode press presser foot down to lower the presser foot to embroidery position.



Needle Stop Up/Down

Press needle stop up/down to set the position of the needle when you stop sewing. The needle will move up or down when you press the button. The indicator light is on when needle stop down is set.

Tip: You can also tap the foot control to raise or lower the needle once you stop sewing. Tapping the foot control does not change the set stop position.



Presser Foot Up and Extra Lift

Press the presser foot up button once to raise the presser foot. Press again and the presser foot will raise to extra lift position, and the feed teeth will be automatically lowered to make it easier to get heavy fabric under the presser foot.

In embroidery mode, the extra lift makes it easier to insert or remove the hoop.



Stitch Re-Start

When you stop sewing in the middle of a stitch, press stitch re-start to begin sewing at the beginning of the stitch. The stitch or stitch sequence will remember any special settings you made.



Immediate Tie-Off

Press immediate tie-off while sewing and your machine sews a few tie-off stitches and stops automatically. By pressing the tie-off button once more while the action indicator is lit, the function can be turned off.

Tie-off is used to tie off a stitch. Touch the button to turn the function on/off. The indicator next to the tie-off button is lit when the function is active. When beginning to sew with the tie-off function activated, your machine sews a few tie-off stitches and continues with the selected stitch.

You can activate automatic tie-off in settings, see Tie-Off Options.



Automatic Needle Threader

See Using the Automatic Needle Threader, page 35 to learn how to place the thread for automatic needle threading. When the thread is in place, touch this button to thread the needle automatically.

Note: To prevent damage to the automatic needle threader, needle, presser foot or other attached accessories, read the instructions carefully on how to use the automatic needle threader before using it.

Accessories

Included Accessories

1. Thread net (4)
2. Universal tool
3. Seam ripper
4. Brush
5. Bobbins (9)
6. Edge/Quilting guide (to use insert into the presser foot ankle)
7. Multipurpose tool
8. Thread cone holder (2)
9. Spool cap, small (2)
10. Spool cap, medium (2)
11. Spool cap, large (2)
12. Hoop clips (20)
13. Large spool holder (2)
14. Straight Stitch Plate

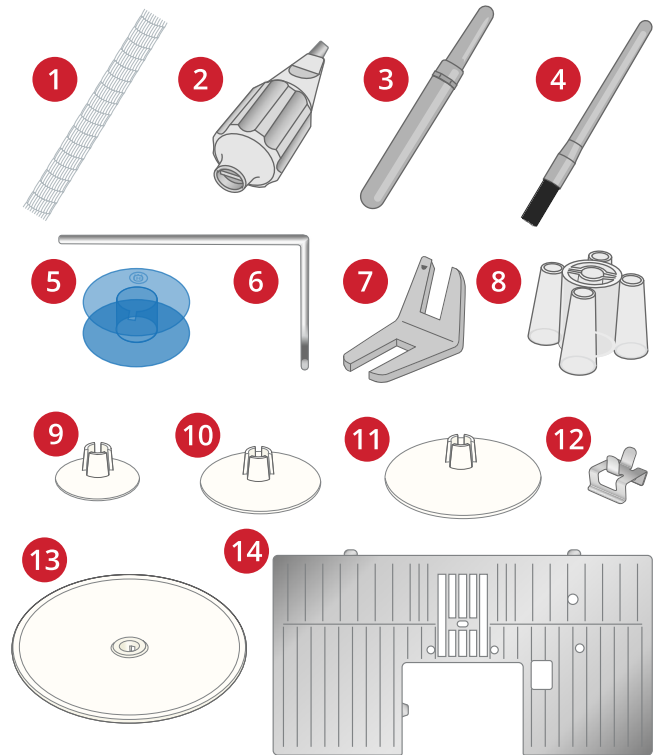

Included Accessories Not in Picture

- Complimentary software (PC and MAC) to download, see Free mySewnet Embroidery Software (PC and MAC).
- Luggage style carrying bag with packing insert for embroidery unit
- Foot control
- Power cord
- Needles

Included Hoops

1. DESIGNER™ Regal Hoop (465x260mm)
2. DESIGNER™ Royal Hoop II (360x200mm)
3. DESIGNER™ Jewel Hoop II (240x150mm)
4. DESIGNER™ Splendid Square Hoop II (120x120mm)
5. Hoop adapter

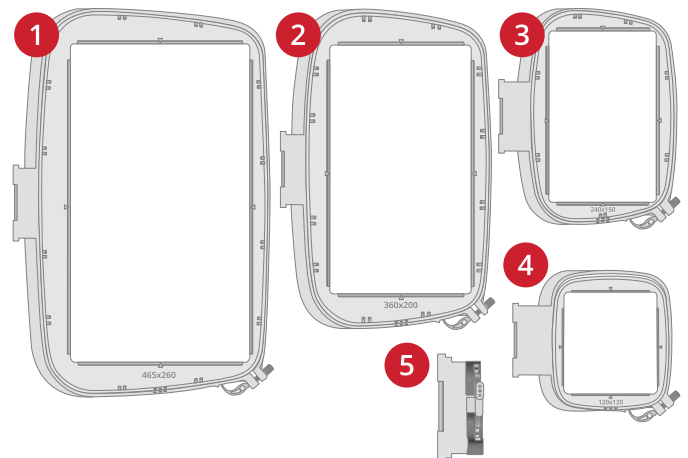

Presser Feet

Note: For the best sewing results, use only presser feet designed for and compatible with your DESIGNER EPIC™ 3 machine.

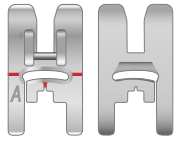

Utility Foot A for IDF System

Snapped onto the machine upon delivery. Used mainly for straight stitching and zigzag stitching with a stitch length longer than 1.0mm.

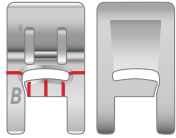

Decorative Stitch Foot B

For sewing close zigzag stitches (satin stitches) with less than 1.0mm stitch length, other utility stitches or decorative stitches, use this foot. The tunnel on the underside of the foot is designed to feed smoothly over the stitches.

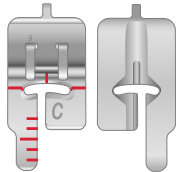

Buttonhole Foot C

For manual buttonholes. This foot has guidelines to determine buttonhole length. The middle guideline measures 1/2" (12mm) from the needle position. The two tunnels on the underside of the foot ensure smooth feeding over the buttonhole columns. The finger on the back of the foot holds cording for corded buttonholes.

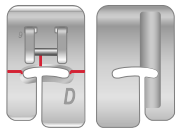

Blindhem Foot D

For blindhem stitches. The inner edge of this foot guides the fabric. The right toe of the foot is designed to ride along the hem edge.

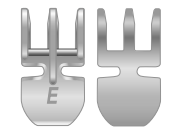

Zipper Foot E for IDF System

This foot can be snapped on either to the right or to the left of the needle. This makes it easy to sew both sides of the zipper. Move needle position to the right or left to sew closer to zipper teeth or for covering large cording.

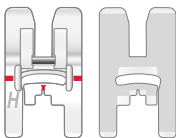

Non-Stick Glide Foot H for IDF System

This foot, with a non-stick coating underneath, is used when sewing foam, vinyl, plastic, or leather to keep these materials from sticking to the foot.

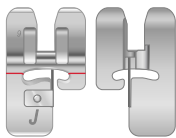

Edging Foot J for IDF System

Used for overcasting and seam/overcasting, with stitches that have a stitch width of 5.0 and 5.5mm. Stitches form over the pin which prevents puckering at the edge of the fabric.

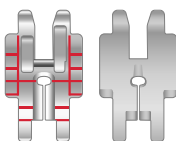

Adjustable 1/4" Foot for IDF System

Used when piecing quilt blocks. The foot has distance guideline marks 1/4" (6mm) and 1/8" (3mm) from the needle. The hole in the foot is oval shaped allowing you to adjust the needle position slightly to fit your project.

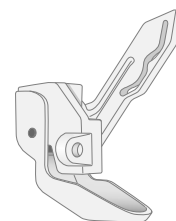

Sensor Q-Foot

The Sensor Q-Foot is recommended for hoop embroidery.

This foot is also used for free motion sewing, free motion quilting and free motion embroidering. When using the Sensor Q-Foot for free motion, select free motion spring action in the free motion menu in sewing mode.



Embroidery/Darning Foot R

Used for free motion embroidery, free motion quilting, free motion stitching and free motion darning. When using this foot, select free motion floating in the free motion options pop-up in sewing mode.

This foot can also be used for hoop embroidery.

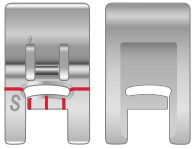

Side-Motion Foot S

Used for side-motion/omnimotion stitches.

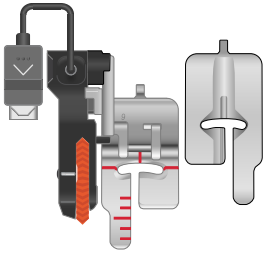

Sensor One-Step Buttonhole Foot

Plug into the machine then enter the desired buttonhole length to sew sensor one-step buttonholes. The middle guideline measures $\frac{1}{2}$ " (12mm) from the needle position. The two tunnels on the underside of the foot ensure smooth feeding over the buttonhole columns. The finger on the back of the foot holds cording for corded buttonholes.

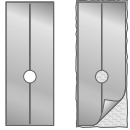







Self-Adhesive Glide Plates













If sewing on foam, vinyl, plastic, or leather, the material can stick to the foot and prevent the sewing machine from feeding properly. When using any of the above materials, sew on a piece of scrap fabric, to make sure the machine feeds smoothly. If not, fasten the self-adhesive glide plate to the underside of the presser foot.

Stitch Overview





The Utility stitches are divided into several sub categories. See a selection of the stitches and descriptions below.









Utility Stitches I, Basic Stitches

Stitch	Nº	Presser foot	Name	Description
	A1	A	Straight stitch, left needle position	For all types of sewing.
	A2	A	Straight stitch, center needle position	For all types of sewing.
	A3	A	Straight stitch with reinforced tie-off	For all types of sewing. Begins and ends with forward and reverse stitches.
	A4	A	Straight stitch, right needle position	For all types of sewing.
	A5, A6, A7	A	Zigzag, left, center and right needle position	For sewing on lace, trims and appliqués.
	A8, A9, A10	A	Reinforced straight stitch, left, center and right needle position	Triple and elastic, for reinforced seams. For top stitch, increase the stitch length.
	A11	A	Reinforced zigzag stitch	For joining fabric edge to edge or overlapping in leather. For decorative sewing.
	A12	A	Three-step zigzag	For overcasting, mending, sewing on patches and elastic. Suitable for light and medium weight fabrics.
	A13	A	Four-step zigzag	For overcasting, mending, sewing on patches and elastics on loosely woven fabrics.
	A14	D	Woven blind hem stitch	Blind hems in medium and heavy woven fabrics.
	A15	A	Gathering stitch	No fix stitch in the beginning of the seam for easy gathering.
	A16	A	Shell edge stitch	For edging, sewing over the edge on light woven fabrics. Sew woven fabrics on bias.
	A17	A	Bridging stitch	For joining two pieces of fabric with finished edges and for elastic shirring.
	A18	B	Honey Comb	For decorative hems, and for elastic shirring.
	A19	B	Herringbone	For joining two pieces of batting or fabric with finished edges. For embellishment and quilting.
	A20	A	Basting stitch	For temporary seams. The long stitches and reduced tension make the seams easy to unravel.
	A21	A	Straight basting stitch	To baste, press the foot control and the machine will make two stitches, stop and raise the foot. When the presser foot lifts, move the fabric to the next baste position and press the foot control. Feed teeth lowered automatically.









Stitch	Nº	Presser foot	Name	Description
	A22	A	Zigzag basting	To baste, press the foot control and the machine will make two stitches, stop and raise the foot. When the presser foot lifts, move the fabric to the next baste position and press the foot control. Feed teeth lowered automatically.
	A23, A24, A25	A	Stretch stitch, left, center and right needle position	For seams in tricot and stretch fabrics.
	A26	J	Seam/overcast stitch	Seam and overcast in one step along the edge or trim later. For light stretch and non-stretch fabrics.
	A27	J	Stretch seam/overcast stitch	Seam and overcast in one step along the edge or trim later. For medium and heavy stretch fabrics.
	A28	B	Double overlock stitch	Seam and overcast in one step along the edge or trim later. For heavy stretch and heavy woven fabrics.
	A29	A	Overlock stitch	Seam and overcast in one step along the edge or trim later. For medium stretch fabrics.
	A30	A	Flatlock stitch	Decorative hems and overlapped seams, belts and bands. For medium/heavy stretch fabrics.
	A31	D	Stretch blind hem stitch	Blind hems in medium and heavy stretch fabrics.
	A32	B	Elastic/casing stitch	For overlapped seams in tricot. To sew casing over narrow elastic.
	A33	A	Serpentine stitch	For mending and elastic applications.
	A34	A	Elastic/Smocking stitch	Sew over two rows of elastic thread for elastic shirring.
	A35	J	Three-step zigzag	For overcasting, mending, sewing on patches and elastic. Suitable for light and medium weight fabrics.
	A36	A	Two-step zigzag	For joining two pieces of lace, and for elastic shirring.













Utility Stitches 2, Appliqué & Mending

Stitch	Nº	Presser foot	Name	Description
	A2:1	A	Hand-look Appliqué Stitch	To sew appliqués with a hand-look stitch.
	A2:2	A	Hand-look Appliqué Stitch	To sew appliqués with a hand-look stitch.
	A2:3	B	Hand-look Appliqué Stitch	To sew appliqués with a hand-look stitch.
	A2:4	A	Blanket Stitch	For edge finishing.
	A2:5	A	Hand-look Appliqué Stitch	To sew appliqués with a hand-look stitch.

Stitch	Nº	Presser foot	Name	Description
	A2:6	A	Hand-look Appliqué Stitch	To sew appliqués with a hand-look stitch.
	A2:7	B	Bartack stitch	Reinforce pockets, shirt openings, belt loops as well as at lower end of a zipper.
	A2:8	B	Bartack, manual	Reinforce pockets, shirt openings, belt loops as well as at lower end of a zipper.
	A2:9	A	Darning stitch (forward and backward)	Darn and mend small holes in work clothes, jeans, tablecloths and linen towels. Stitch over hole, touch reverse for continuous darning and auto stop.
	A2:10	A	Darning stitch (side to side)	For mending small tears.
	A2:11	A	Reinforced darning stitch	Darn and mend work clothes, jeans, tablecloths and linen towels. Stitch over hole, touch reverse for continuous darning and auto stop.
	A2:12	B	Darning stitch (four-step)	A group of four stitches perfect for mending small tears. Stitch #1 and #3 are sewn in a forward motion, stitch #2 and #4 are sewn backwards. To change stitch and direction touch the reverse button. <i>Tip: Press fusible interfacing on the wrong side before mending the tear.</i>
	A2:13	A	Belt loop stitch	For securing belt loops.

Utility Stitches 3, Buttonholes

Stitch	Nº	Presser foot	Name	Description
	A3:1	Sensor Buttonhole foot/C	Wide bartack buttonhole	For medium and heavy fabrics with extra cutting space.
	A3:2	Sensor Buttonhole foot/C	Bartack buttonhole	For most fabric weights.
	A3:3	Sensor Buttonhole foot/C	Rounded bartack buttonhole	For light weight fabrics.
	A3:4	Sensor Buttonhole foot/C	Round end buttonhole	For blouses and children's garments.
	A3:5	Sensor Buttonhole foot/C	Keyhole buttonhole	Square end for tailored jackets, coats, etc.
	A3:6	Sensor Buttonhole foot/C	Tapered keyhole buttonhole	Tapered end for tailored garments.
	A3:7	Sensor Buttonhole foot/C	Decorative fashion buttonhole	For most fabric weights.
	A3:8	Sensor Buttonhole foot/C	Decorative fashion buttonhole	For most fabric weights.

Stitch	№	Presser foot	Name	Description
	A3:9	Sensor Buttonhole foot/C	Heavy duty buttonhole	With reinforced bartacks
	A3:10	Sensor Buttonhole foot/C	Heavy reinforced buttonhole	For utility and heavy fabrics.
	A3:11	C	Medium/heavy reinforced buttonhole	For medium and heavy fabrics.
	A3:12	C	Medium reinforced decorative buttonhole	For medium fabrics.
	A3:13	Sensor Buttonhole foot/C	Heirloom buttonhole	For hand look on fine and delicate fabrics. <i>Tip: For jeans buttonholes, increase length and width of the buttonhole. Use thicker thread.</i>
	A3:14	Sensor Buttonhole foot/C	Rounded heirloom buttonhole	For hand look on fine and delicate fabrics.
	A3:15	A	Leather buttonhole (straight stitch)	For leather and suede.
	A3:16	A	Bound buttonhole (straight stitch)	With extra cutting space for bound buttonholes.
	A3:17	-	Automatic button sewing	For sewing on buttons.
	A3:18	B	Round eyelet	For belts, laces, etc.
	A3:19	B	Teardrop eyelet	For laces, embellishments.
	A3:20	B	Oval eyelet	For laces, embellishments.

Stitch Menu Overview

There are several different stitch menus with stitches for all purposes. For detailed description of a stitch, use the quick help function, see Quick Help.

Stitch Menu Name	Description
A — Utility Stitches	Stitches for garment sewing and mending. There is also a menu with 4-way stitches that for example can be used when sewing patches.
B — Crafting Stitches	Decorative stitches to embellish crafts.
C — Satin & Scallop Stitches	Create details and finish edges with beautiful scallop and/or satin stitches.
D — Quilt Stitches	Stitches for all types of quilting techniques.
E — Vintage Stitches	A selection of vintage inspired stitches for crazy patch quilting and decorative stitching.
F — This & That	Children, holiday motifs, foods, drinks and garment care stitches to use for decorative sewing.
G — Omnimotion Stitches	Wide stitches formed with side motion. The stitch width can be up to 54mm wide. Program these stitches into an unlimited number of combinations. Or use the single motifs stitches as monograms.
H — Dimensional Stitches	Another dimension of stitches. Here, you can find appliqué and pop-up stitches together with stitches embellished with sequins or tassels but also stitches to be decorated with crystals.
I — Building Blocks	Single or groups of stitches that can be combined together into exciting combinations or larger stitch shapes. You can use the tutorials found in the JoyOS Advisor to guide you through the different techniques.
J — Specialty Stitches	Sew special techniques including candlewicking, edging and yarn stitching. There is also a category with floating stitches giving the appearance of stitches floating on the fabric surface. Using projection, select single or groups of stitches that are guided with projected lines to combine together into exciting combinations or larger stitch shapes. Extra accessories may be needed. Use quick help for detailed information. You can also use the tutorials found in the JoyOS Advisor to guide you through the techniques found in the Specialty Stitches menu.

Alphabets

Stitch fonts are available in block, comic, outline, script, grand alphabet and cyrillic alphabets.

2 Preparations



Unpacking Machine and Embroidery Unit

After lifting the machine out of the box and removing all packing material and the plastic bag, wipe the machine, particularly around the needle and needle plate to remove any oil before sewing.

When unpacking the embroidery unit, do not throw away the styrofoam inside the embroidery unit carrying bag, as this is designed for storing the embroidery unit when not in use.

Note: Your DESIGNER EPIC™ 3 machine is adjusted to provide the best stitch result at normal room temperature. Extreme hot and cold temperatures can affect the sewn results.

Note: The machine is delivered with two red safety catches; one attached to the presser foot bar and one in the accessory tray. These should be removed before sewing.

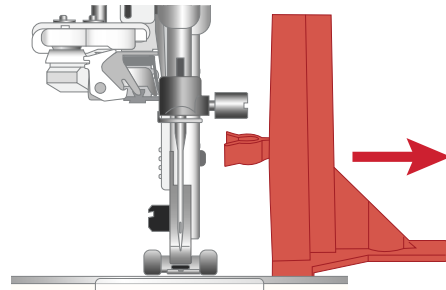

Remove the safety catches around the presser foot bar and under the accessory tray

Connecting the Power Cord and Foot Control

Among the accessories you will find the power cord and the foot control.

The power cord has a power supply unit (PSU) (A). The fixed cord (B) attached to the PSU unit, should be connected to the sewing machine. The loose cord (C) should be connected to the socket (D) in the PSU unit and then to the wall socket.

Note: Only use the power supply unit and cord supplied with your machine. No other cord can be used. If the cord is damaged or lost, make sure to replace it with the same type of cord, available at an authorized HUSQVARNA® VIKING® Dealer.

- Pull out the cord (E) from the foot control. Connect the foot control cord to the socket (1) on the bottom right side of the machine.

Note: Before plugging in the foot control, check to ensure that it is type "FR5" (see underside of foot control).

- Connect the cord (B) to the rear socket (2) on the bottom right side of the machine. Plug the power cord into the wall socket.
- Press the power button (3) to turn on power and light.

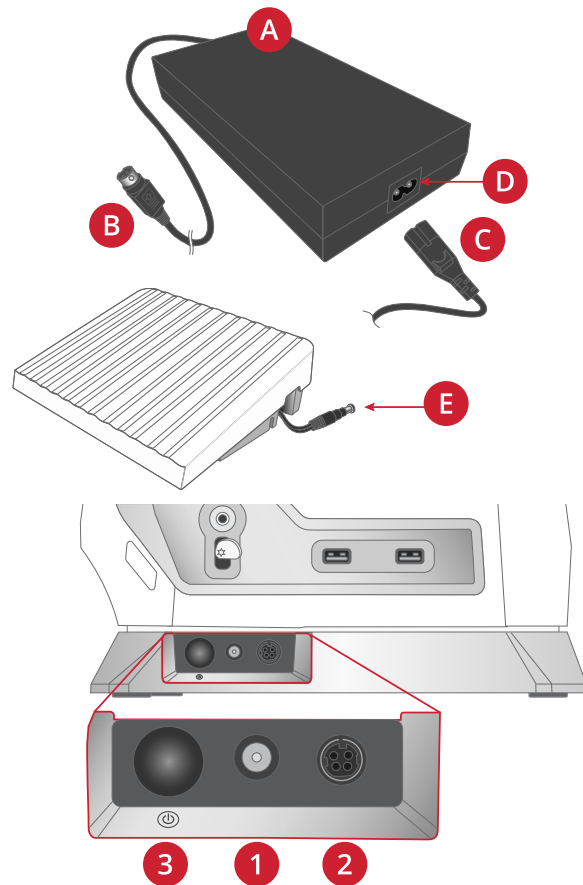

For the USA and Canada

This sewing machine has a polarized plug (one blade wider than the other). To reduce the risk of electric shock, this plug is intended to fit in a polarized outlet only one way. If the plug does not fit fully in the outlet, reverse the plug. If it still does not fit, contact a qualified electrician to install the proper outlet. Do not modify the plug in any way.

Packing Away After Sewing

Long press the power button (about 2 seconds) to turn off the machine.

Note: If the button is released within 2 seconds, the machine will remain with power on.

Unplug the cord from the wall socket and then from the machine.

Unplug the foot control cord from the machine. Pull the cord gently and release. The cord will retract into the foot control.

Place all accessories in the accessory tray. Slide the tray on to the machine around the free arm.

Place the foot control in the space above the free arm.

Put on the cover.

Tip: The user's guide and power cord can be stored in the pocket of the cover.

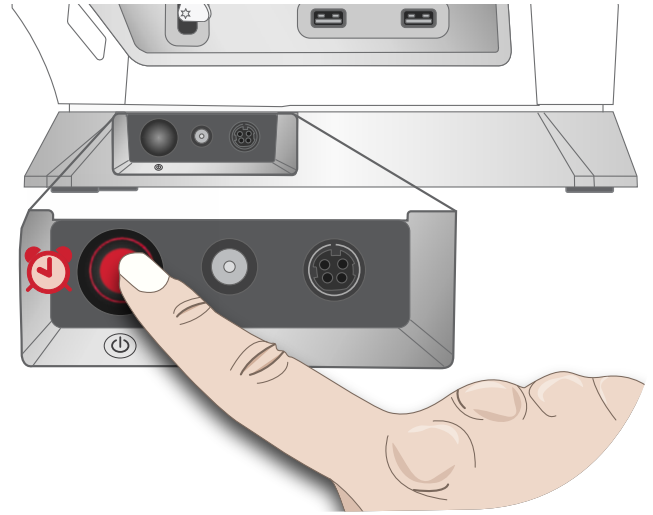

USB Ports

Your machine has two USB ports for connecting USB devices such as a memory stick. USB plugs can only be inserted one way – do not force them into the ports! To remove, carefully pull the USB device.

Note: Make sure that the USB stick you use has the format FAT32.

Using a USB Device

The external device button in file manager is only active when a device is connected to the machine USB port.

Note: Do not remove the USB device if a loading spinner is shown on the screen or while the file manager is shown. Removing the device at that time can damage the files on your USB device.

Read more in USB Device.

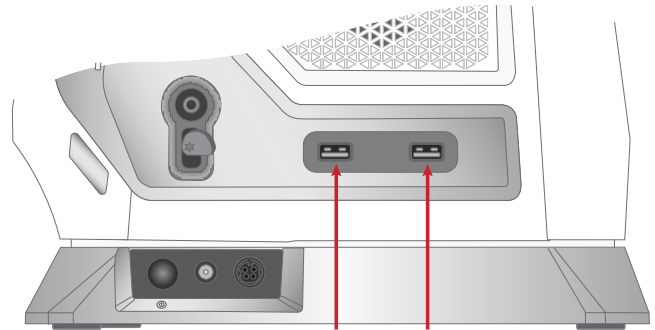

LED Lights

Your machine has LED lights which distribute the light evenly over the sewing area and eliminate shadows. You can adjust the brightness of the light in the settings menu.

Free Arm

To use the free arm, slide off the accessory tray. When attached, a hook keeps the accessory tray locked to the machine. Remove the tray by sliding it to the left.

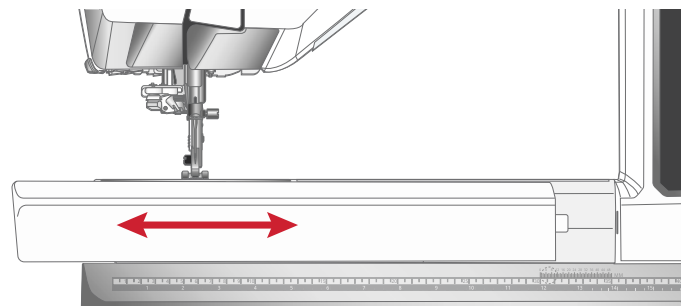

Manual Thread Cutter

There are three manual thread cutters on your machine.

The first one (A) is close to the bobbin winder spindle for cutting the thread before and after winding.

The second one (B) is on the left side of the machine for manually cutting top and bobbin thread. Pull both threads into the cutter from the back to the front and pull down quickly.

The third one (C) is next to the bobbin area for cutting the bobbin thread after placing the bobbin in the machine.

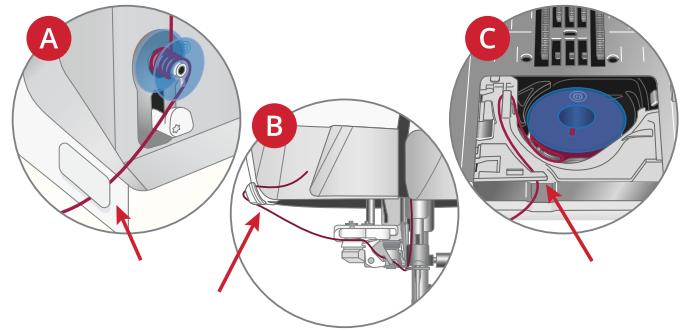

Thread Sensor

If the needle thread breaks or bobbin thread is running low, the machine stops and a pop-up appears on the screen.

If needle thread breaks: Remove the thread completely, re-thread the machine and touch OK in the pop-up.

If bobbin thread is running low: You can continue sewing without closing the pop-up before the bobbin thread runs out completely. This gives you an opportunity to plan where to stop and change the bobbin. When the bobbin is replaced with a full one, touch OK in the pop-up.

Speed Control Slider

The speed control slider sets the maximum sewing speed. To increase sewing speed, slide the slider to the right, to decrease sewing speed, slide the lever to the left.

A pop-up appears on screen when adjusting the slider, indicating which speed level is set. The speed setting is also shown on your screen.

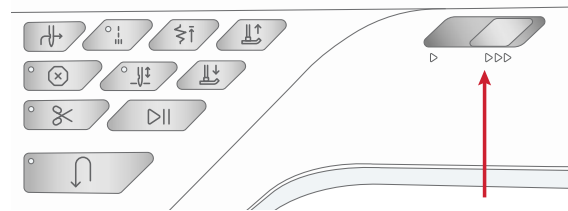

Telescopic Thread Guide

The telescopic thread guide is always used when threading your machine for sewing/embroidery and bobbin winding. The telescopic thread guide helps straighten the thread, preventing it from tangling or breaking. The thread guide together with the vertical spool pins make it possible to successfully use even very large thread cones.

Extending and Retracting the Telescopic Thread Guide

Hold the telescopic thread guide by the markings as illustrated and pull it straight up until it clicks into place.

To retract, hold the thread guide by the markings and push it straight down.

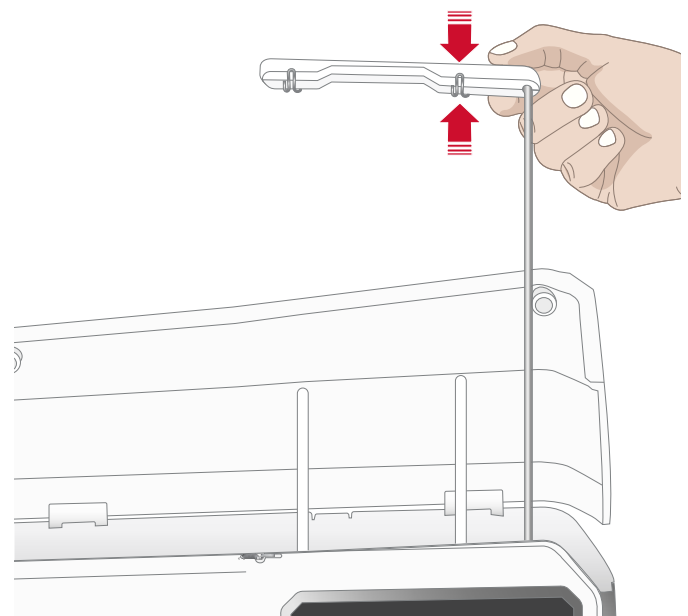

Spool Pins

Your machine has two spool pins; a main spool pin and an auxiliary spool pin. The spool pins are designed for all types of thread.

Use the main spool pin (A) when threading the upper thread and for bobbin winding through the needle. For regular sewing and embroidery thread, use the main spool pin in vertical position. Place the spool pin in the horizontal position if you want to keep the machine threaded and close the lid when you have finished sewing. Remember to place the spool pin back in the vertical position when you start to sew/embroider again.

Note: Tilting the spool pins is not possible with large thread spools or cones.

You may get better results if you tilt the spool pin to the horizontal position when using small spools of specialty thread. See Threading Tips and Hints, page 39.

Use the auxiliary spool pin (B) when winding a bobbin from a second spool of thread or for a second spool when sewing with a twin needle.

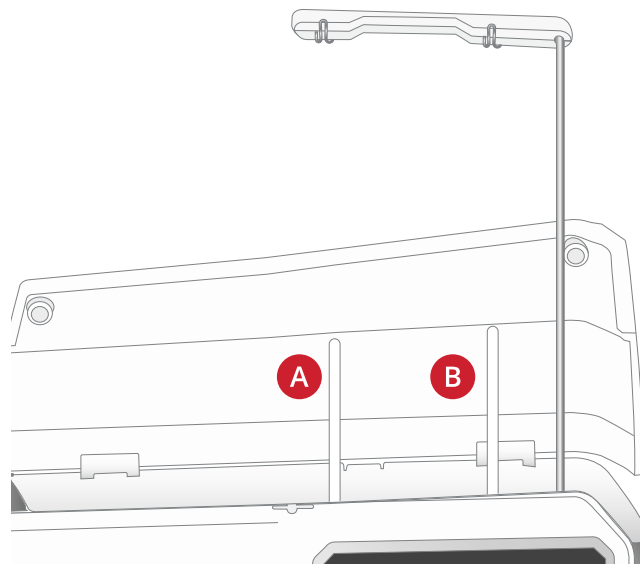

Main spool pin (A) and auxiliary spool pin (B)

Spool Caps

Spool caps in three sizes are included with your machine. For most types of thread spools, no spool cap is needed except when the thread on the spool is running low. If the thread is snagging on the top of the thread spool, place a spool cap on top. Always use a spool cap slightly larger than the thread spool to prevent the thread from snagging. The flat side of the spool cap should be pressed firmly against the spool. There should be no space between the spool cap and the thread spool.

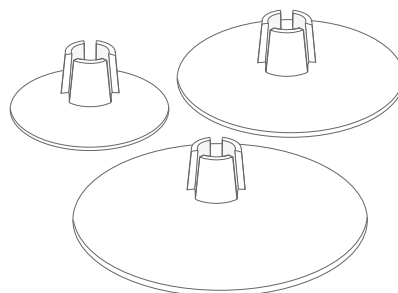

Threads

There are many threads on the market today developed for different purposes.

Your DESIGNER EPIC™ 3 machine is designed for a wide variety of threads and spool sizes. See Threading Tips and Hints, page 39 for information on achieving optimal results with different types of thread and different sizes/styles of thread spools.

All Purpose Sewing Thread

All purpose sewing thread is made of synthetic, cotton or cotton covered polyester. This type of thread is used for most sewing projects, including garments, home decor, and quilting.

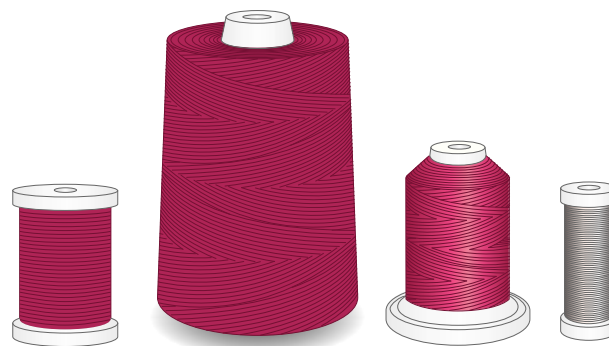

Embroidery Thread

Embroidery thread is made from a variety of fibers: rayon, polyester, acrylic or metallic. These threads create a smooth glossy appearance for embroidery and other decorative stitching.

Embroidery thread is not typically used in the bobbin unless both sides of the project will be seen. A light weight, embroidery bobbin thread is often used in the bobbin instead. The lighter weight thread does not build up under the embroidery.

Note: When using a metallic or a flat film thread for embroidery, you may need to use a needle with a larger eye and lower the embroidery speed.

Transparent Thread

Transparent thread, also called monofilament thread, is a single clear synthetic thread. It is used for quilting and other sewing techniques. When winding a bobbin, wind at half speed and fill the bobbin half full.

Needles

The sewing machine needle plays an important role in successful sewing. Use only quality needles. We recommend needles of system 130/705H. The needle package included with your machine contains needles of the most frequently used sizes.

The Needle Guide, available in JoyOS ADVISOR™, let you learn more about different needles and the color coding used to define what type and size they are.



Be sure to match the needle to the thread you are using. Heavier threads require a needle with a larger needle eye. If the needle eye is too small for the thread the automatic needle threader may not work properly.

Universal Needle

Universal needles have a slightly rounded point and come in a variety of sizes. For general sewing in a variety of fabric types and weights.



Stretch Needle

Stretch needles have a special scarf to eliminate skipped stitches when there is a flex in the fabric. For knits, swimwear, fleece, synthetic suedes and leathers.



Embroidery Needle

Embroidery needles have a special scarf, a slightly rounded point and a slightly larger eye to avoid damage to thread and materials. Use with metallic and other specialty threads for embroidery and decorative sewing.



Denim Needle

Denim needles have a sharp point to penetrate tightly woven fabrics without deflecting the needle. For canvas, denim, microfibers.



Wing Needle

Wing needles have wide wings on the side of the needle to poke holes in the fabric when sewing entredeux and other hemstitches on natural fiber fabrics.

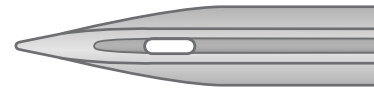

Important Needle Information



Change the needle often. As a general rule, needles should be changed every 6-8 hours of actual stitching time.

Change the needle often. Always use a straight needle with a sharp point (A).

A damaged needle (B) can cause skipped stitches, breakage or snapping of the thread. It can also damage the needle plate.

Do not use asymmetrical twin needles (C), they can damage your sewing machine.

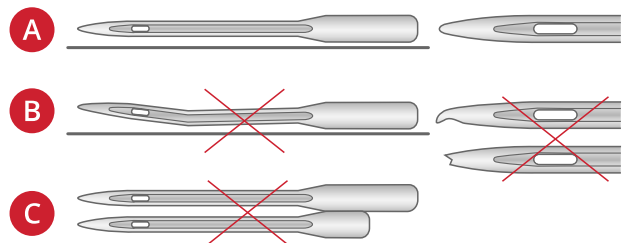

Changing the Needle

1. Use the hole in the multipurpose tool to hold the needle.
2. Loosen the needle screw with the universal tool.
3. Remove the needle.
4. Insert the new needle using the multipurpose tool. Push the new needle upwards with the flat side away from you until it will go no further.



It is very important that the needle is inserted all the way in order for the automatic needle threader to work properly.

5. Tighten the needle screw with the universal tool.



Use the rounded end of the universal tool to loosen and tighten the screw. The universal tool is magnetic and will hold the screw, making it easy to replace and less likely to be lost.

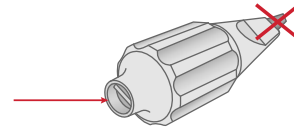
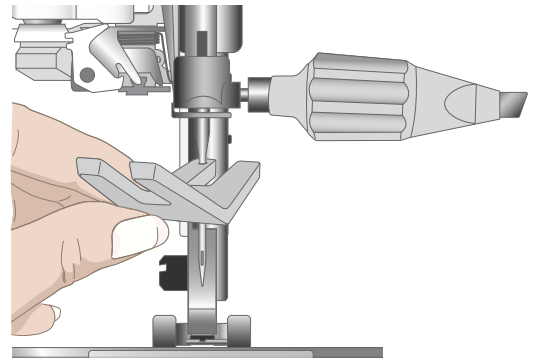

Threading

Make sure that the presser foot and needle are in the up position.

Note: When using thread cones, place a cone holder on the spool pin before placing the thread cone. This prevents the thread cone from wobbling.

Tip: When removing the thread cone from the spool pin, the cone holder might become stuck inside the thread cone. Push it out gently from the top.

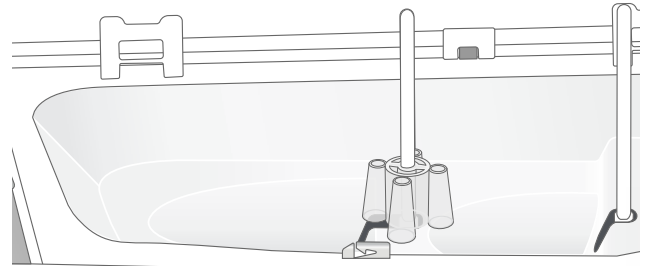

Threading the Upper Thread

For most regular thread qualities and spool sizes, threading the upper thread from the main (left) spool pin in the vertical position is recommended for optimal sewing results.

If you experience problems with the thread or sewing result, there are alternative ways to position the thread spool. See Threading Tips and Hints, page 39.

1. Hold the telescopic thread guide by the markings and pull it straight up until it clicks into place.
2. Raise both spool pins to vertical position. Place the thread spool on the main spool pin (left).

Using both hands, place the thread behind the left clip on the telescopic thread guide (A). The thread should run from right to left.

3. Hold the thread with two hands as illustrated. Floss the thread under the thread guide (B) from front to back. Pull thread back into and through threading slot (C).

Note: Continue to hold the thread lightly next to the thread guide (B) throughout the threading process. This will create a bit of tension on the thread and ensure that the thread is properly seated in the threading path.

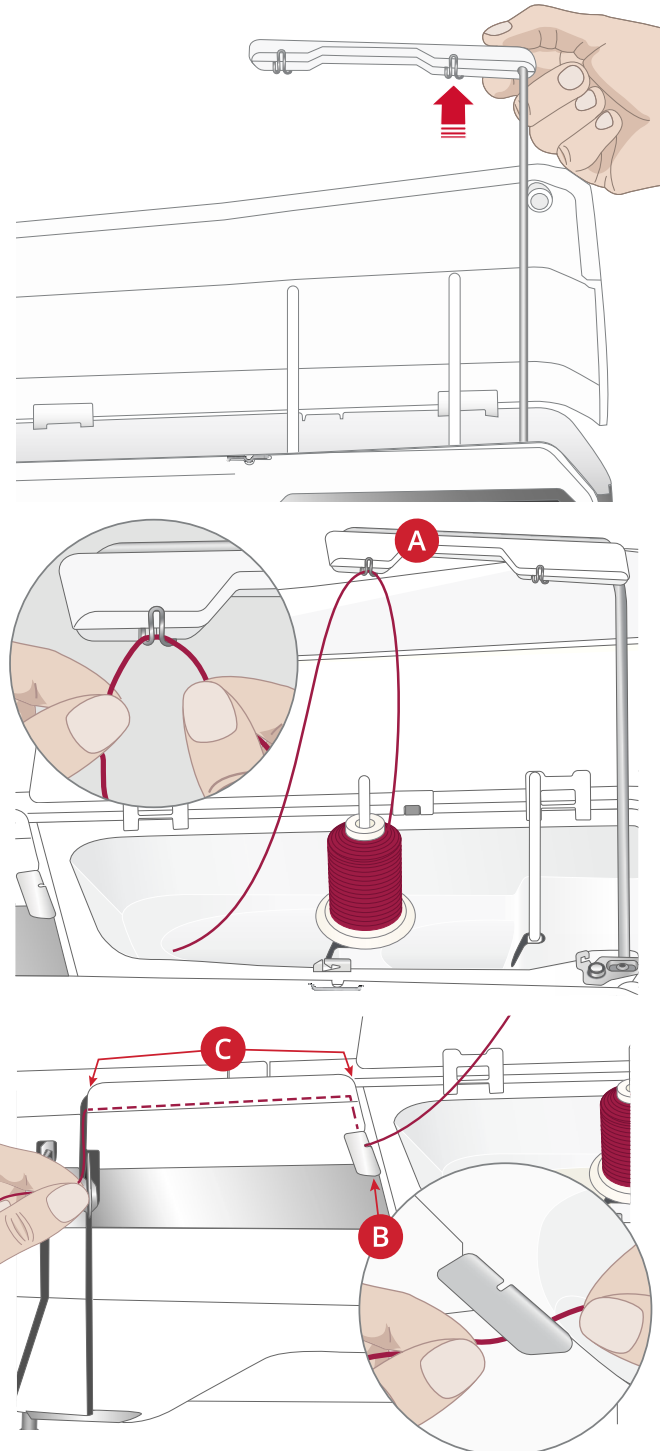

4. Pull the thread between the thread tension discs (D). Thread down through the right threading slot and then upwards through the left threading slot. Bring the thread from the right into the take-up lever (E) until it clicks into place (F), and down in the left threading slot to the last thread guide (G) just above the needle.
5. Thread the needle using the automatic needle threader or manually.



Before using the automatic needle threader, carefully read the instructions and recommendations, see Using the Automatic Needle Threader, page 35.

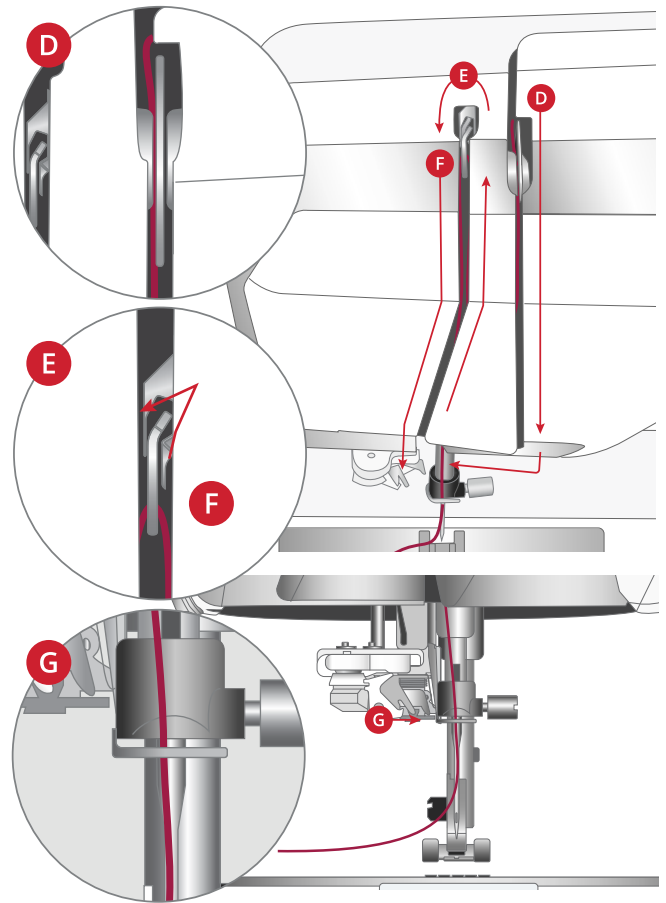

Automatic Needle Threader

Using the Automatic Needle Threader

The needle threader allows you to thread the needle automatically by simply touching a button.

 *Make sure that the needle is inserted correctly and pushed up all the way into the needle clamp before using the automatic needle threader. Check that the needle is not damaged or bent, and make sure to match the thread weight and needle size according to our recommendations in *Selecting Correct Thread/Needle Combination*, page 36.*

1. Place the thread under the hook (A) and pull it between the discs (B) until it “clicks” into place.
2. Pull the thread up to the sewing head thread cutter and cut excess thread by pulling the thread from back to front in the thread cutter.
3. Touch the automatic needle threader button on the sewing head. The presser foot is automatically lowered during the threading sequence, and will rise again when threading is finished.

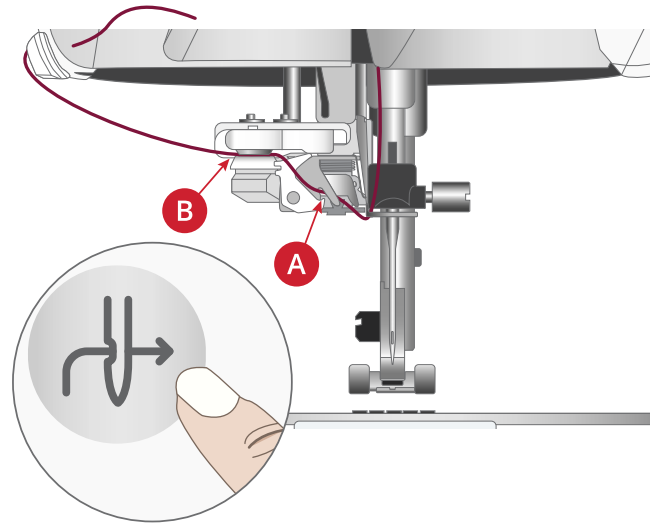

 *The needle threader is designed to be used with needles size 70-120. You cannot use the needle threader with needles size 65 or smaller, wing needles, twin needles or triple needles.*

Specialty threads such as invisible and other stretchy threads, metallic or flat metallic threads, and some heavy weight threads may not be caught correctly by the hook on the automatic needle threader. If this happens, the needle will not be threaded. Try using the automatic needle threader again or thread the needle manually.

When threading the needle manually, make sure that the needle is threaded from front to back.

The automatic needle threader cannot be used with all optional accessories available for your DESIGNER EPIC™ 3 machine. To avoid damage to the needle threader and/or optional accessory we recommend using the automatic needle threader before attaching the accessory or thread the needle manually.

 *Before using the needle threader with the Sensor One-Step Buttonhole Foot attached, lift the wheel of the foot up to avoid damage to the needle threader and foot.*

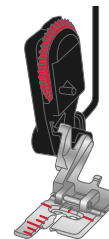

Selecting Correct Thread/Needle Combination



The combination of the thread weight and the needle size is extremely important when using the automatic needle threader. Unsuitable combinations, such as using a heavy weight thread for a fine needle, may cause damage to the needle threader.

Avoid using fine needles with heavy fabrics to reduce the risk of bending the needle. Using the automatic needle threader with a bent needle may cause damage to the needle threader.

Fabric		Thread	Needle
Woven light	Chiffon, organza, batiste, challis, crepe de chine, etc.	Light weight threads: <ul style="list-style-type: none"> • fine cotton, polyester or silk sewing thread • rayon embroidery thread 	Universal 130/705H 70/10-80/12
Woven medium	Calico, quilting fabrics, crepe, broadcloth, velvet, etc.	Medium weight threads: <ul style="list-style-type: none"> • fine/normal cotton or polyester sewing thread • rayon embroidery thread 	Universal 130/705H 80/12-90/14
Woven heavy	Denim, tweed, canvas, terrycloth, etc.	Medium/heavy weight threads: <ul style="list-style-type: none"> • normal cotton or polyester sewing thread • top stitching thread • rayon embroidery thread 	Universal 130/705H 90/14-110/18
Stretch light	Tricot, single knit jerseys, etc.	Light weight threads: <ul style="list-style-type: none"> • fine cotton or polyester sewing thread • rayon embroidery thread 	Stretch 130/705H-S 75/11
Stretch medium	Sweater knits, double knit, velour, swimwear, etc.	Medium weight threads: <ul style="list-style-type: none"> • normal cotton or polyester sewing thread • rayon embroidery thread 	Stretch 130/705H-S 90/14
Stretch heavy	Sweater knits, fleece, etc.	Medium weight threads: <ul style="list-style-type: none"> • normal cotton or polyester sewing thread • rayon embroidery thread 	Stretch 130/705H-S 90/14
Leather	Suede and leather	Medium weight threads: <ul style="list-style-type: none"> • normal cotton or polyester sewing thread • rayon embroidery thread 	Stretch 130/705H-S 90/14
Vinyl	Vinyl, faux leather and suede	Medium weight threads: <ul style="list-style-type: none"> • normal cotton or polyester sewing thread • rayon embroidery thread 	Universal 130/705H 80/12

Note: Specialty fabrics and threads may require a special needle for best stitch results. Refer to your HUSQVARNA® VIKING® retailer for more information on needle types and sizes for your sewing needs.

Threading for Twin Needle

Replace the sewing needle with a twin needle. Make sure that the presser foot and needle are in the up position.

Note: When using large thread cones on the auxiliary spool pin, place the large spool holder with the flat side up and a cone holder on the spool pin before adding the thread cone.

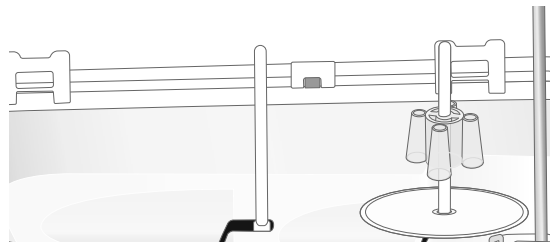

1. Raise both spool pins to vertical position. Place a thread spool on each spool pin.

Using both hands, place the thread from the main spool pin behind the left clip on the telescopic thread guide (A), from right to left, and then place the thread from the auxiliary spool pin behind the right clip on the telescopic thread guide (B), from right to left.

Note: Do not place the thread from the auxiliary spool pin behind both clips on the telescopic thread guide, as this will create too much thread tension.

2. Hold both threads with two hands as illustrated. Floss the threads under the thread guide (C) from front to back. Pull the threads together back into and through threading slot (D).

Note: Continue to hold the threads lightly next to the thread guide (C) throughout the threading process. This will create a bit of tension on the threads and ensure that the threads are properly seated in the threading path.

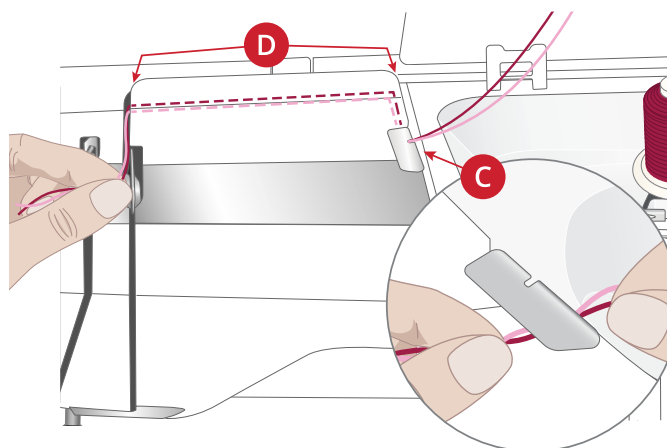
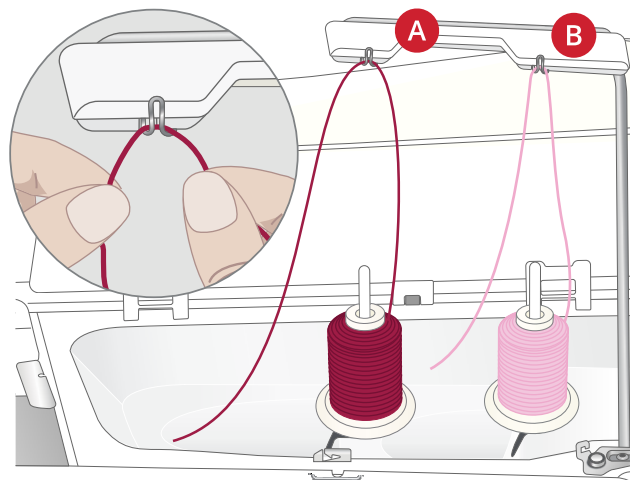

3. Pull the threads between the thread tension discs (E). Make sure that you place one thread to the left and one to the right side of the tension discs.

Thread down through the right threading slot and then upwards through the left threading slot. Bring the threads from the right into the take-up lever (F) until they click into place (G), and down in the left threading slot. One thread should be placed inside the needle thread guide (H) and the other one outside. Make sure the threads do not become twisted together.

4. Thread the twin needle manually.



Do not use the automatic needle threader for twin needle!

Note: The weight and irregular surface of specialty threads such as metallic increases the amount of friction on the thread. By reducing the tension, the risk of needle breakage and thread breakage is reduced.

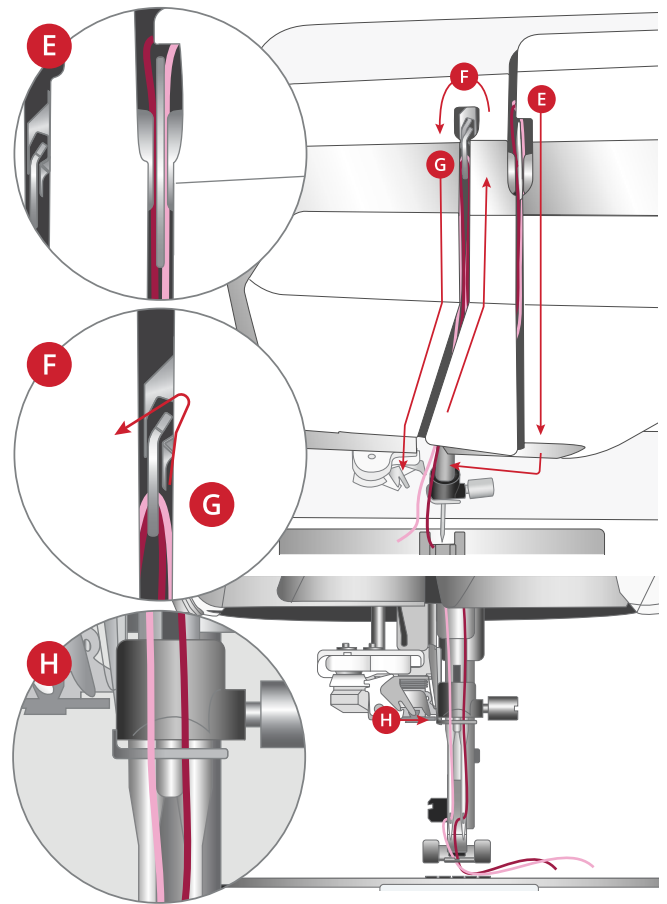

Threading Tips and Hints

There are many threads on the market today developed for different purposes. The quality and structure of the thread as well as the shape and size of the thread spool can affect the behavior of the thread. Threads can also behave differently if the spool is full or nearly empty.

If experiencing problems, try the tips and hints below.

Note: Always test sew on a scrap piece of fabric to check the sewing result.

If the Thread Spool is Pulled up on the Spool Pin

When the thread on the spool is running low, the thread can snag on the edge of the spool and pull the spool up on the spool pin. Place a spool cap on top of the thread spool to keep it in place. Always use a spool cap slightly larger than the thread spool to prevent the thread from snagging. The flat side of the spool cap should be pressed firmly against the spool. There should be no space between the spool cap and the thread spool.

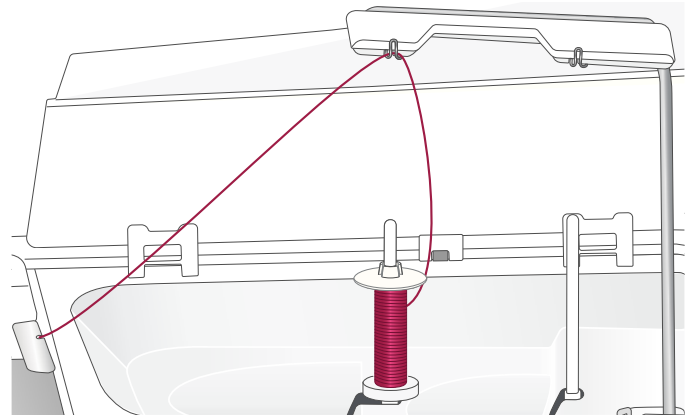

If the Thread Slides Down on the Standing Thread Spool

If the thread is of a quality that unwinds easily and slides down on the standing thread spool it can get caught under the thread spool around the spool pin and break. Place the large spool holder on the spool pin with the flat side up before placing the thread spool.

If the thread spool has the same diameter as the large spool holder, place a thread net as illustrated from below over the spool before placing it on the spool pin.

Note: To prevent snagging or increased thread tension on the thread, the thread net should cover the lower part of the thread spool only, not the top where the thread spool narrows.

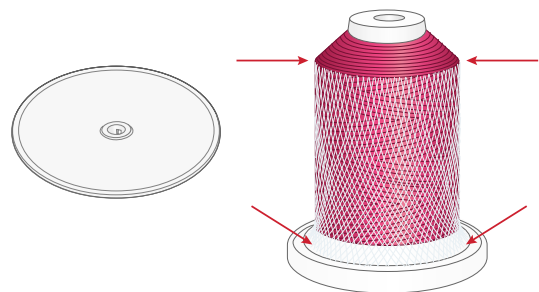

If the Thread Tangles or Curls when Unwinding from the Spool

For smaller spools of specialty thread, the main spool pin can be used in tilted position, allowing the thread to roll off the spool.

Place the thread spool on the spool pin. Do not place a spool cap on top of the spool as it may prevent the spool from rotating. Pull thread up to the telescopic thread guide and thread as described under Threading the Upper Thread, page 33.

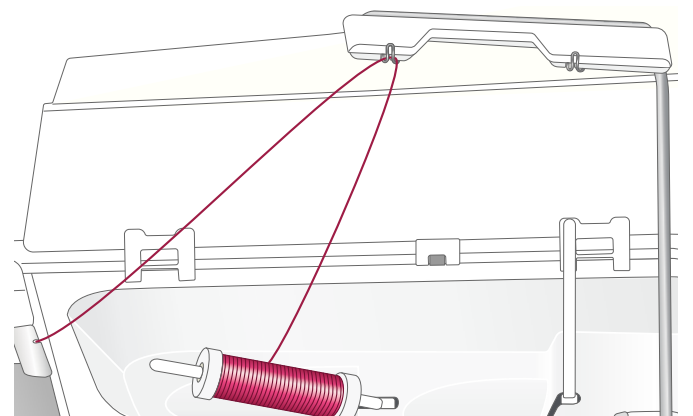

Bobbin Winding

All types of thread, including specialty threads such as invisible or other stretchy threads, metallic or flat metallic threads, should be wound directly from the auxiliary spool pin without passing the needle and presser foot.

Note: Always wind specialty threads at lower speed.

Note: When using large thread cones, place the large spool holder with the flat side up and a cone holder on the auxiliary spool pin before adding the thread cone.

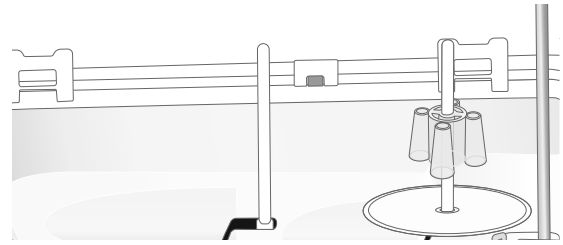

1. Place a thread spool on the auxiliary spool pin.

Using both hands, pull the thread behind the right clip on the telescopic thread guide (A). The thread should run from right to left.

2. Bring the thread through bobbin winding thread guide (B) from back to front and to the right.

Bring the thread through bobbin winding thread guide (C), around the thread tension disc (D) and down through the last two thread guides (E and F) as illustrated.



For some specialty threads, following the normal threading path will result in a bobbin that is wound too tight. If this happens, bypass thread guide (C) and thread tension disc (D) to reduce the amount of tension on the thread. Pull the thread from thread guide (B) directly to thread guide (E) instead.

3. Place the bobbin on the bobbin winder (G) on the lower right side of the machine. The bobbin only fits on one way, with the logo facing out.



The bobbins included are designed especially for your DESIGNER EPIC™ 3 machine. Only use HUSQVARNA® VIKING® category 8 bobbins.

Wind a few turns of thread clockwise around the bobbin and cut excess thread with the thread cutter (H).

4. Push the bobbin winding lever (I) towards the bobbin. A pop-up appears on screen. To adjust winding speed drag the slider. Stop and start the bobbin winding with the button in the pop-up.
5. When the bobbin is full, the bobbin winding lever will move back and the winding will stop automatically. The pop-up message closes. Remove the bobbin and cut the thread using the bobbin winding thread cutter (H).

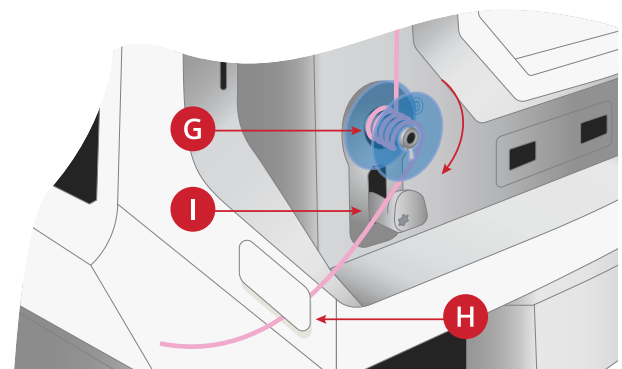
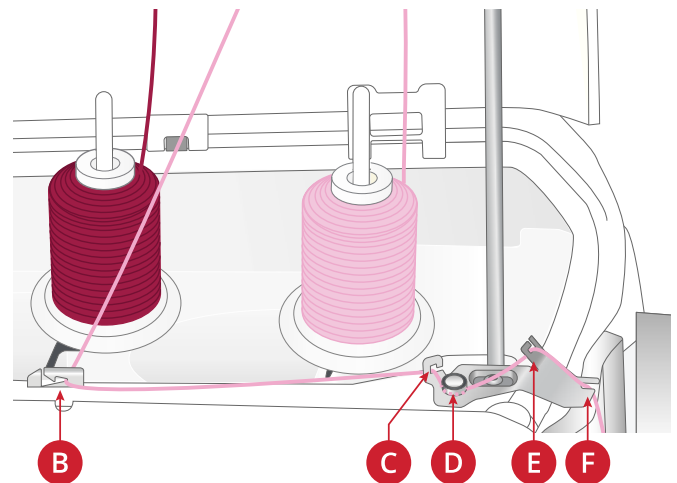
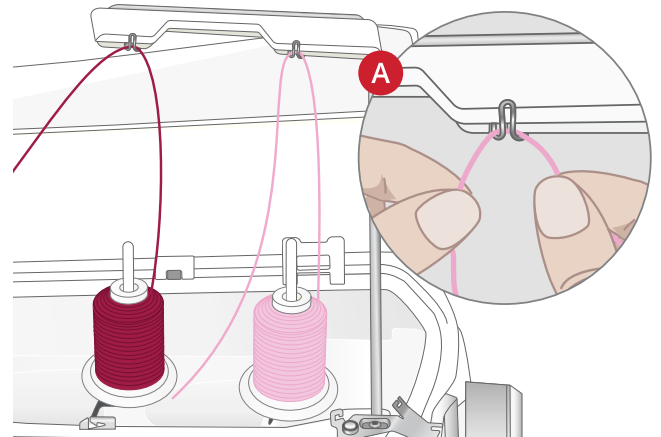

Winding Through the Needle

When using the same thread in the needle and bobbin, it is convenient to wind a new bobbin directly through the needle without having to unthread/re-thread your machine.



We do not recommend winding speciality threads such as invisible or other stretchy threads, metallic or flat metallic threads through the needle. Very heavy and coarse threads should not be wound through the needle either as the thread tension can become too high, causing the needle to break. Wind specialty threads as described under Bobbin Winding, page 40.

1. Make sure that the presser foot and needle are in the up position.
2. Thread the machine as described under Threading the Upper Thread, page 33.
3. Pull the thread from the needle, under the presser foot and up to the right.

Note: Always use a metal presser foot when bobbin winding from the needle.

4. Bring the thread from right to left into the bobbin winding thread guide (A), and from left to right through thread guide (B).
5. Bring the thread directly through the two last bobbin winding thread guides (C and D), bypassing the bobbin tension disc.

Note: Bypass the tension disc when winding through the needle.

6. Place the bobbin on the bobbin winder (E) on the lower right side of the machine. The bobbin only fits on one way, with the logo facing out.



The bobbins included are designed especially for your DESIGNER EPIC™ 3 machine. Do not use bobbins from other machine models.

Wind a few turns of thread clockwise around the bobbin and cut excess thread with the thread cutter (G).

7. Push the bobbin winding lever (F) towards the bobbin. A pop-up appears on screen. To adjust winding speed drag the slider. Stop and start the bobbin winding with the button in the pop-up.
8. When the bobbin is full, the bobbin winding lever will move back and the winding will stop automatically. The pop-up message closes. Remove the bobbin and cut the thread using the bobbin winding thread cutter (G).

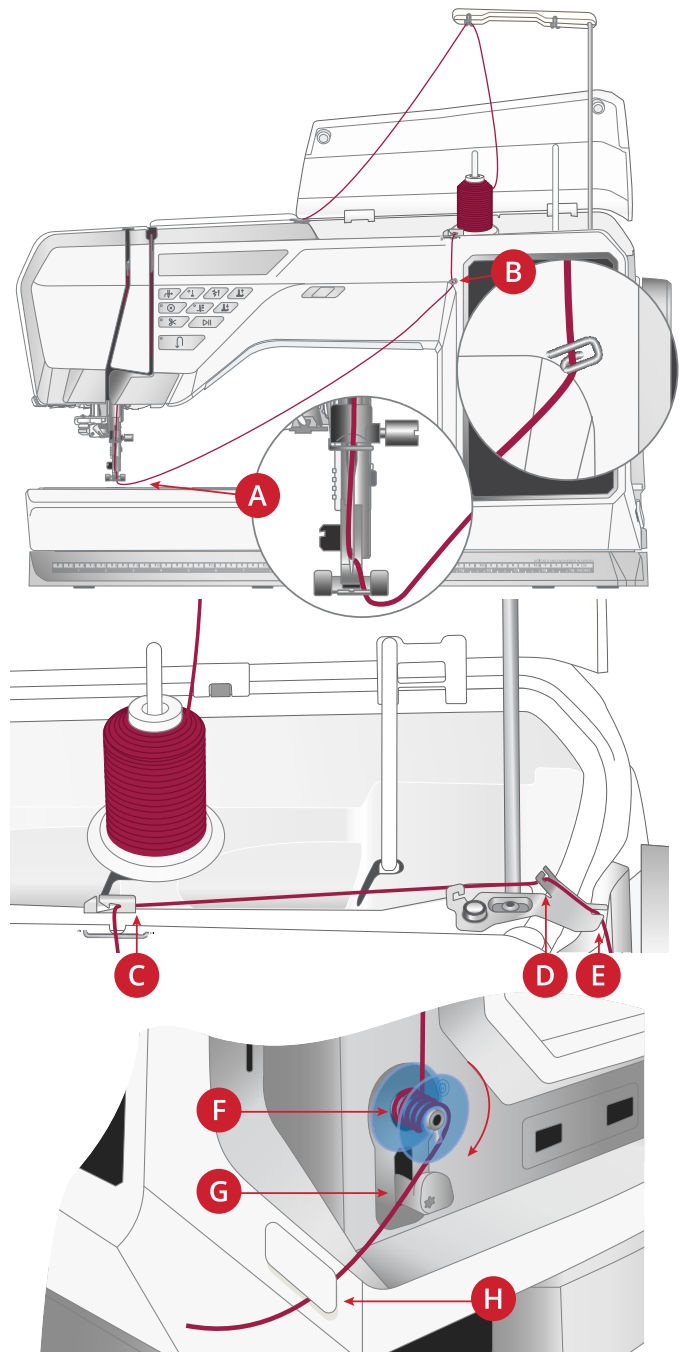

Note: If you experience difficulty winding a bobbin through the needle and you are using a large thread cone, move the cone to the auxiliary spool pin and use the right clip on the telescopic thread guide instead. Place the large spool holder with the flat side up and a cone holder on the auxiliary spool pin before adding the thread cone.

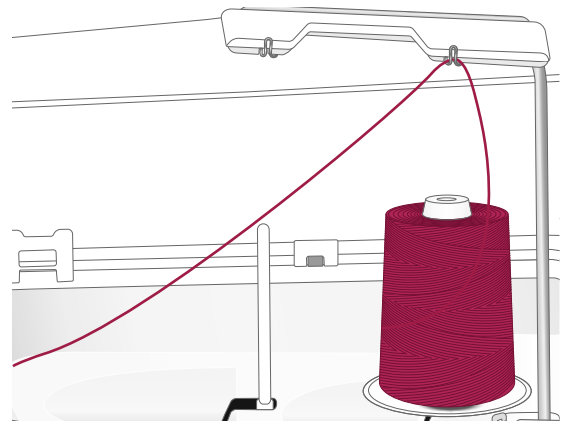

Inserting the Bobbin



Use only the bobbins designed for your DESIGNER EPIC™ 3 machine.

1. Open the bobbin cover by pushing the release button (A) to the right. Remove the cover.
2. Place the bobbin in the bobbin case. It drops in only one way with the logo facing up. The bobbin will then rotate counterclockwise when you pull the thread.
3. Place your finger on the bobbin to keep it from turning as you pull the thread firmly to the right and then to the left into the tension spring (B) until it “clicks” into place. Continue threading around (C) and to the right of the thread cutter (D).
4. Replace the bobbin cover. Pull the thread to the left to cut.

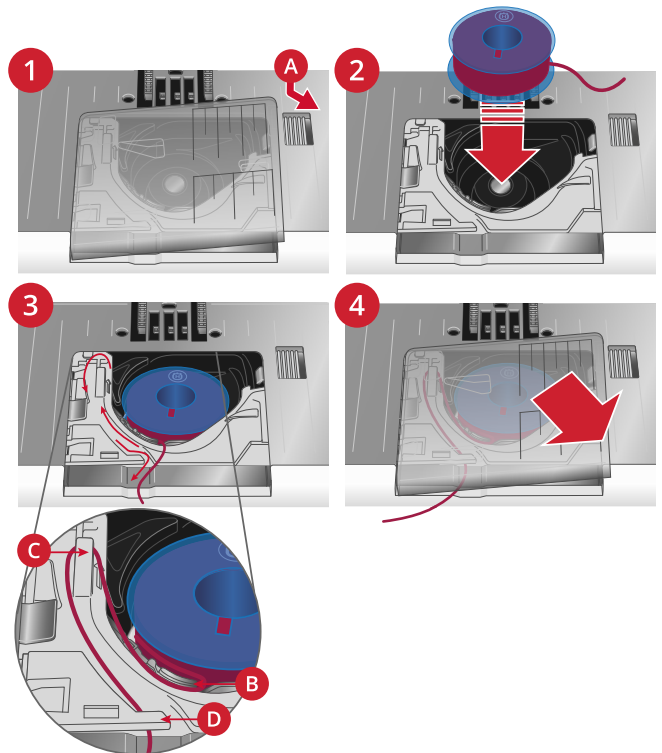

Integrated Dual Feed (IDF) System

When sewing with multiple layers or more challenging fabrics you need an even feed from the top and the bottom and your machine has the ideal solution: the Integrated Dual Feed (IDF) System. The IDF System feeds the fabric from the top and bottom at the same time. The material is fed evenly, eliminating puckering on seams in light weight fabrics such as silk and rayon. The dual feed action of the IDF System prevents layers from shifting while sewing, keeping quilt layers aligned and ensuring a more perfect match when sewing plaid or striped fabrics.

Engaging the IDF System

Important: For all work with the IDF System, use presser feet with the center back cut-out (A). Raise the presser foot to extra high position. Pull the IDF System down until it engages.

Note: Your machine is equipped with an IDF sensor. You will be alerted if the IDF System isn't set according to the stitch recommendations for the selected stitch.

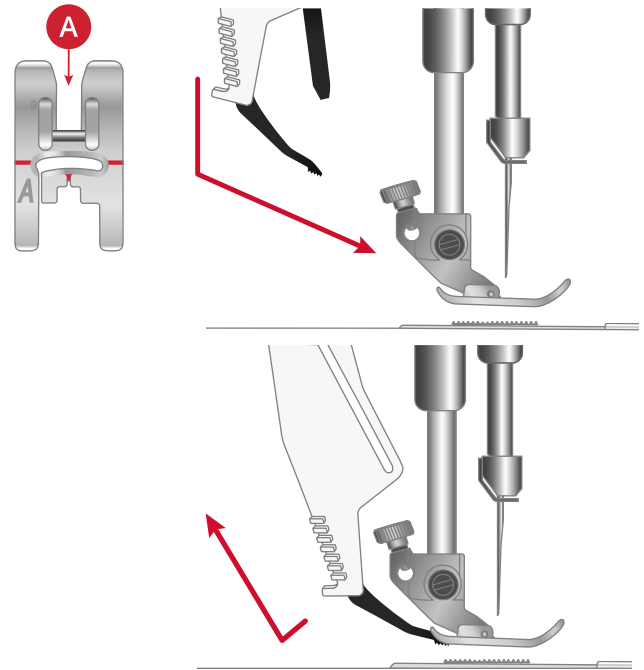

Disengaging the IDF System

Raise the presser foot. Hold the IDF System with two fingers at the ribbed ankle. Pull the IDF System down, then pull it away from you to release the IDF System slowly upward.

Changing the Presser Foot

1. Make sure that the needle is in the highest position. Pull the presser foot down and towards you.
2. Line up the cross pin on the foot with the gap in the presser foot ankle. Push the foot into the gap until the foot snaps into place.

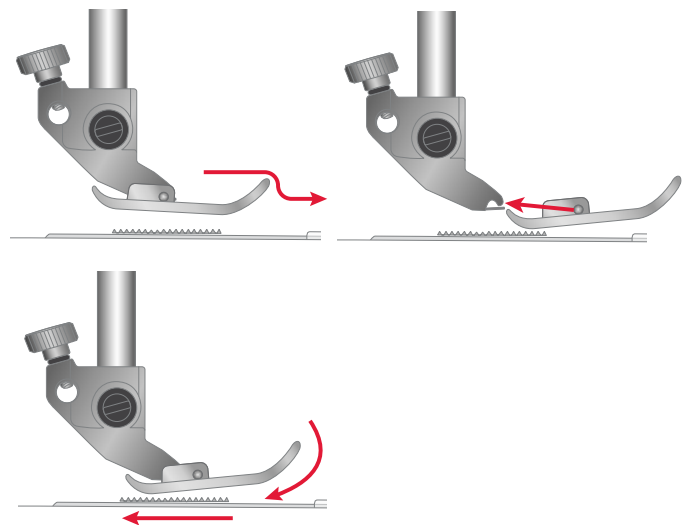

Attaching the Sensor One-Step Buttonhole Foot

1. Snap on the Sensor One-Step Buttonhole Foot.
2. Insert the plug, with the three dots facing out, into the accessory socket at the back of the sewing head.

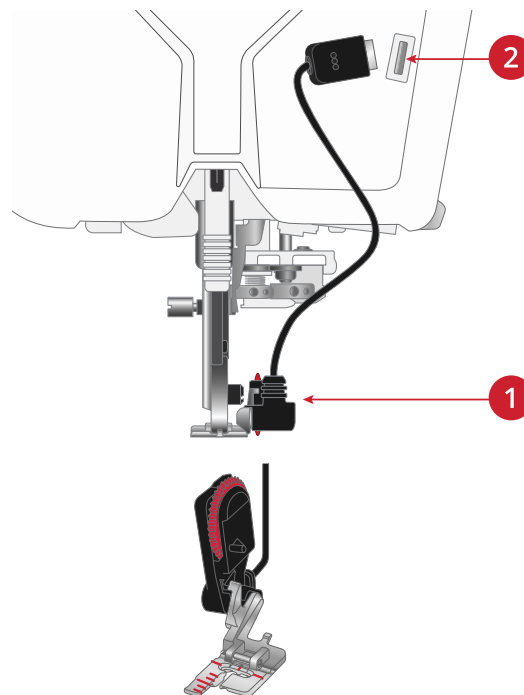

Before using the automatic needle threader with the Sensor One-Step Buttonhole Foot attached, lift the wheel of the foot up to avoid damage to the needle threader and foot.

Attaching the Sensor Q-Foot

1. Using the universal tool, remove the presser foot ankle.

Note: Do not remove the presser foot ankle screw from the universal tool after unscrewing it. The universal tool is magnetic and will hold the screw, making it easy to replace and less likely to be lost.

2. Position the Sensor Q-Foot onto the presser foot bar from behind, lining the hole on the foot up with the hole on the presser foot bar. Lower the needle into the opening of the foot by turning the handwheel towards you. The arm of the presser foot should rest on top of the needle screw. Insert and tighten the presser foot ankle screw using the universal tool.

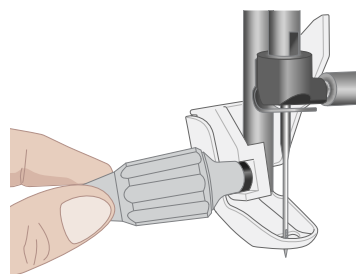
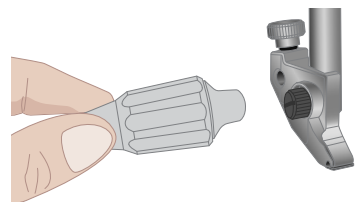

Use the rounded end of the universal tool to loosen and tighten the screw. The universal tool is magnetic and will hold the screw, making it easy to replace and less likely to be lost.

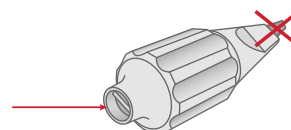

Changing the Needle Plate

The Straight Stitch Plate is recommended for embroidery. It may also be used for certain techniques in sewing mode, such as quilt piecing. The smaller hole in the Straight Stitch Plate supports the fabric closer to the needle and helps prevent the fabric from being pulled down into the bobbin area, especially at the beginning and/or end of a seam.

1. Remove the presser foot. Open the bobbin cover by pushing the release button (A) to the right. Remove the cover.
2. Make sure that the feed teeth are lowered. Place the universal tool under the needle plate as shown and gently turn the universal tool to pop off the needle plate.

Note: Lower the feed teeth by touching the presser foot up and extra lift button.

Note: When changing the needle plate, clean any lint and threads from the bobbin area.

3. With feed teeth lowered, position the Straight Stitch Plate so that it fits into the notches at the back (B). Press the Straight Stitch Plate down until it clicks into place. Replace the bobbin cover.

 *To prevent needle breakage or damage to the plate, remove any accessory that is not compatible with the Straight Stitch Plate, such as twin needle.*

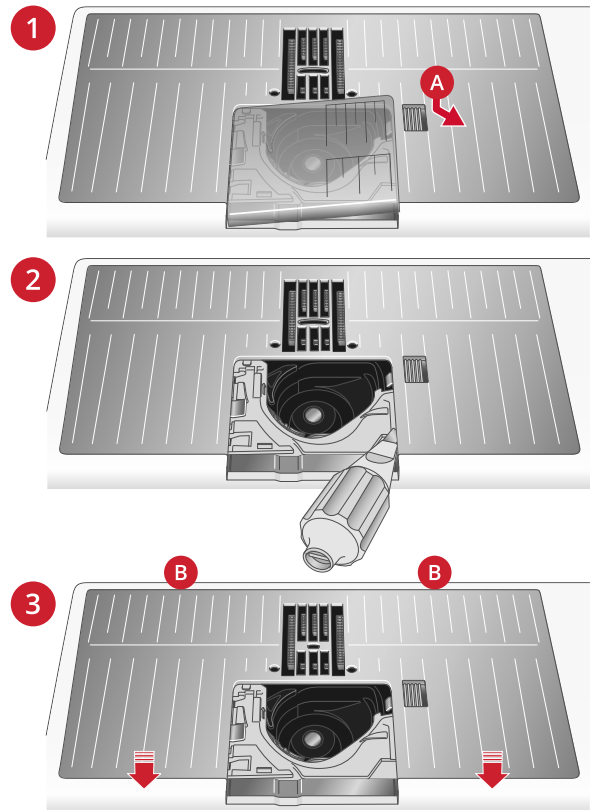

Storing a Needle Plate

Store the needle plate not in use in the bottom of your accessory tray.

1. Insert the back of the plate into the assigned holes as illustrated and lay it down.
2. Push the plate down and to the left to fasten it.
3. To remove the plate, place a finger into the hole to the left of the plate, push right and then lift the plate.

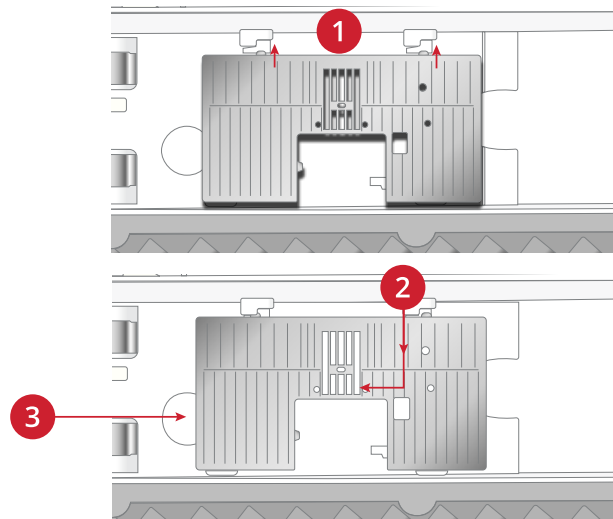

Getting Started with WiFi and mySewnet Cloud

Connect to a Network with WiFi

Touch the WiFi button. Select from the list of available networks. If your network is password protected, you will be prompted to enter the password to connect.

For more information, see WiFi Introduction.



WiFi icon

Connect to mySewnet Services

When you have established a WiFi connection, touch the mySewnet Cloud icon and sign in to My Account. If you do not have a user name and password, select Register to create an account. If you do not have a mysewnet account, you can easily create one, visit mysewnet.com for more information.



mySewnet cloud icon

3 Embroidery Preparations



Embroidery Unit Overview

(type EU 22)

1. Embroidery arm
2. Embroidery hoop release button
3. Embroidery hoop attachment
4. Handle to use for carrying or wall storage
5. Embroidery unit connector (underside)
6. Slot for embroidery unit extension
7. Grip to use when connecting the embroidery unit

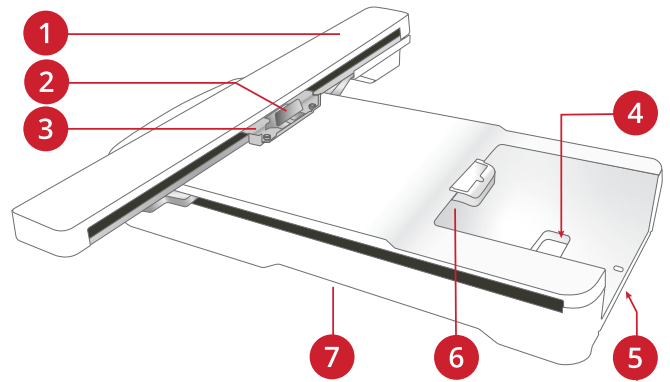

Embroidery Unit Extension Overview

1. Hook to attach the extension to the embroidery unit
2. Hooks to attach the extension to the machine

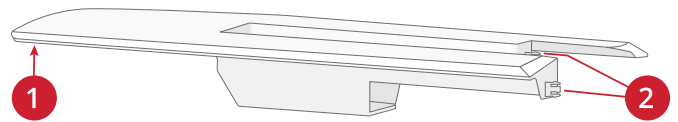

Large Hoop Support Overview

1. Large Hoop Support — Rear
2. Large Hoop Support — Front
3. Hooks to catch the edge of the embroidery unit extension
4. Fold out legs

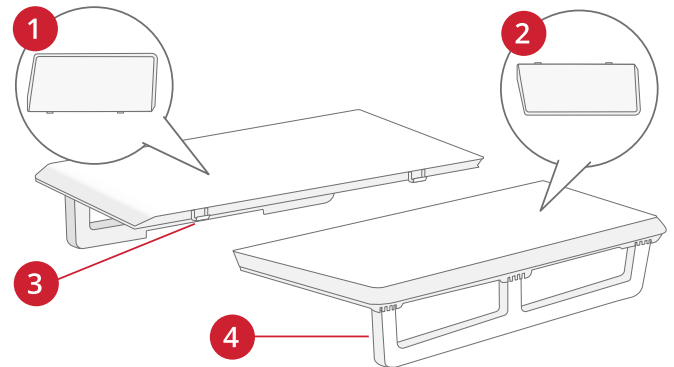

Embroidery Hoop Overview

1. Embroidery hoop connector
2. Outer hoop
3. Inner hoop
4. Center marks
5. Quick release
6. Retaining screw
7. Indication of embroidery area
8. Ribs for fitting the clips

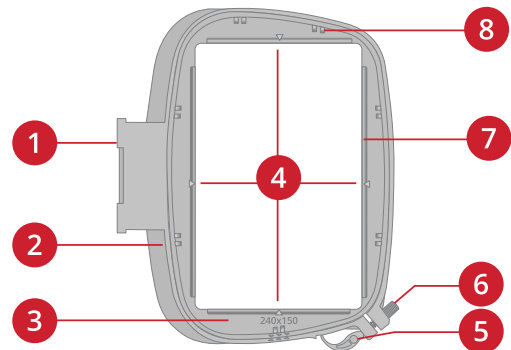

Sensor Q-Foot

The Sensor Q-foot is recommended for hoop embroidery.

See Attaching the Sensor Q-Foot, page 44.

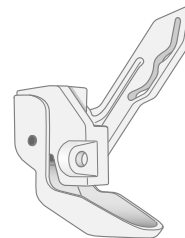

Straight Stitch Plate

The Straight Stitch Plate is recommended for hoop embroidery.

See Changing the Needle Plate, page 45.

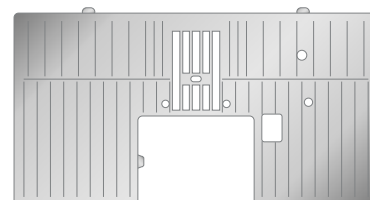

Embroidery Designs

On the HUSQVARNA® VIKING® website you can look through the DESIGNER EPIC™ 3 sampler book for designs and fonts.

All included designs are pictured with information about stitch count (number of stitches in the design), design size, a complete color block list as well as information about special techniques (if applicable).

Connecting the Embroidery Unit

When embroidering always place your sewing machine and embroidery unit on a single, flat, and sturdy surface.

Make sure there is enough space around your machine as the embroidery arm and hoop will move and take up a lot of room. When embroidering using the larger hoops a space of at least 17" (45 cm") is recommended behind the sewing machine.

1. Slide the accessory tray off.

Push to open the embroidery unit connector.

2. Place your hands in the grips on the embroidery unit and carefully lift it in place onto the connector. There is a marking at the base plate and at the bottom of the embroidery unit, those markings should align.
3. The two pins (A) and the two plugs (B) at the underside of the embroidery unit should match the corresponding holes (A) and sockets (B) in the embroidery unit connector.

Once connected, there should be a narrow gap, approx. 1/4" (6mm) between the sewing machine base plate and the embroidery unit.

Note: When embroidering, always use the embroidery unit extension for better stability. When using the larger hoops, also attach the large hoop support to the front and back of the embroidery unit extension. Learn more: Using the Embroidery Unit Extension and Large Hoop Support, page 51.

4. If the machine is turned off, turn it on.

When the embroidery unit is attached, the machine needs to calibrate. If you were already in embroidery mode or when you switch to embroidery mode, a pop-up message tells you to clear the machine area and remove the hoop before calibration. Touch OK. The machine will calibrate and the embroidery arm will move to the ready position.

Note: DO NOT calibrate the machine with the embroidery hoop attached as this can damage the needle, presser foot, hoop and/or the embroidery unit. Be sure to clear all materials from around the machine before calibrating so that the embroidery arm does not bump into anything while calibrating.

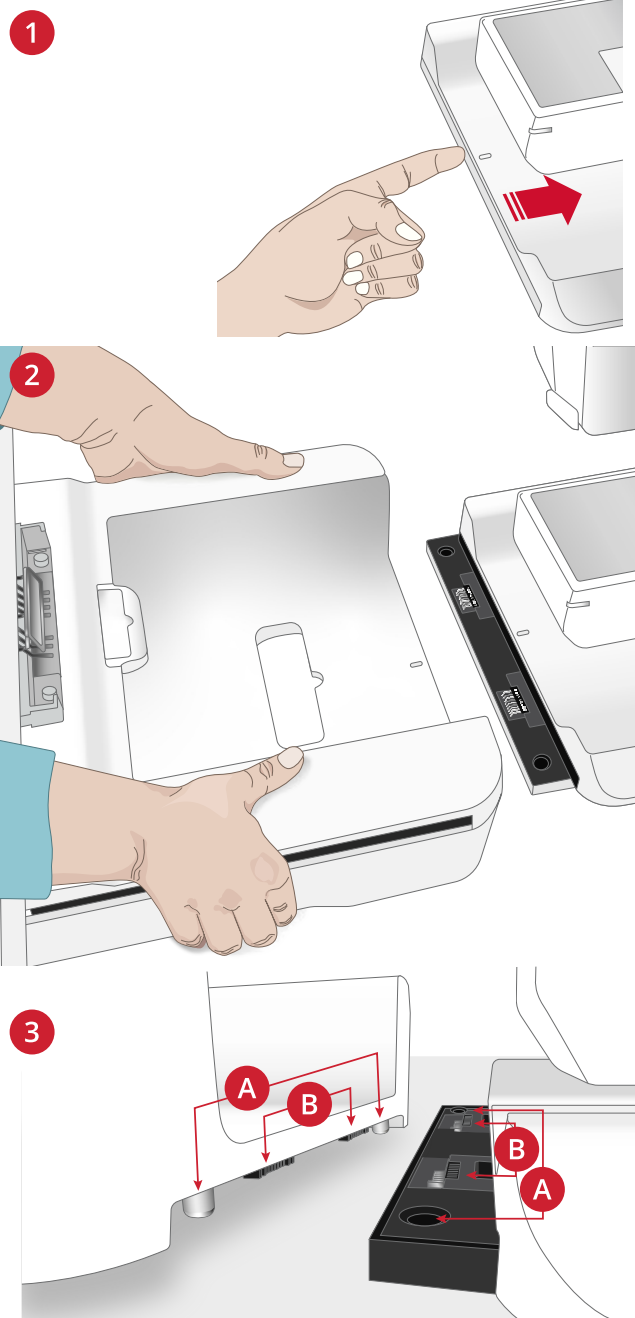

Removing the Embroidery Unit

To store the embroidery unit in the embroidery case, move the embroidery arm to park position. See park position .

Remove the embroidery unit by lifting it off the embroidery unit connector. Always use both hands to lift it off.

Store the embroidery unit in the original styrofoam packing material, placed in the carrying bag. You can also store the embroidery unit hanging on the wall using the handle in the bottom of the embroidery unit.

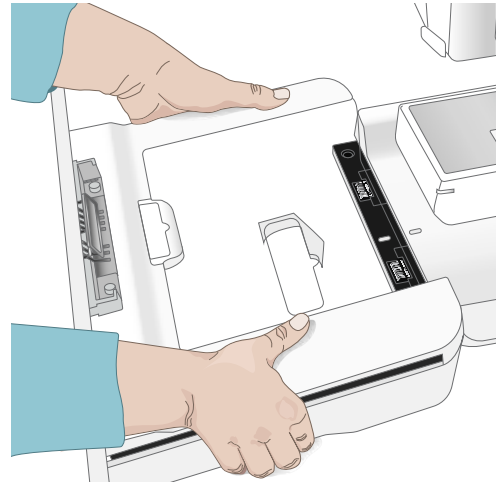

Using the Embroidery Unit Extension and Large Hoop Support

Attach the Embroidery Unit Extension

For all type of embroidery, except free arm embroidery, we recommend using the embroidery unit extension. When attached to the machine and embroidery unit, the embroidery unit extension will give the extra stability needed for high quality embroidery.

When using the largest hoops we also recommend to attach the included large hoop support.

- Attach the embroidery unit.
- Slide the embroidery unit extension under the free arm and push it towards the right.
- Before reaching the inner edge of the sewing machine, raise the rear of the embroidery unit extension slightly to make sure it slides onto the back of the sewing machine. At the same time the hooks (front and back) on the embroidery unit extension (A) should slide into the sockets in the sewing machine (B). When pushed slightly further to the right, the hatches (C) should slide into the grooves (D) on the free arm.
- Once attached properly, the embroidery unit extension should lay totally flat aligning with the embroidery unit.

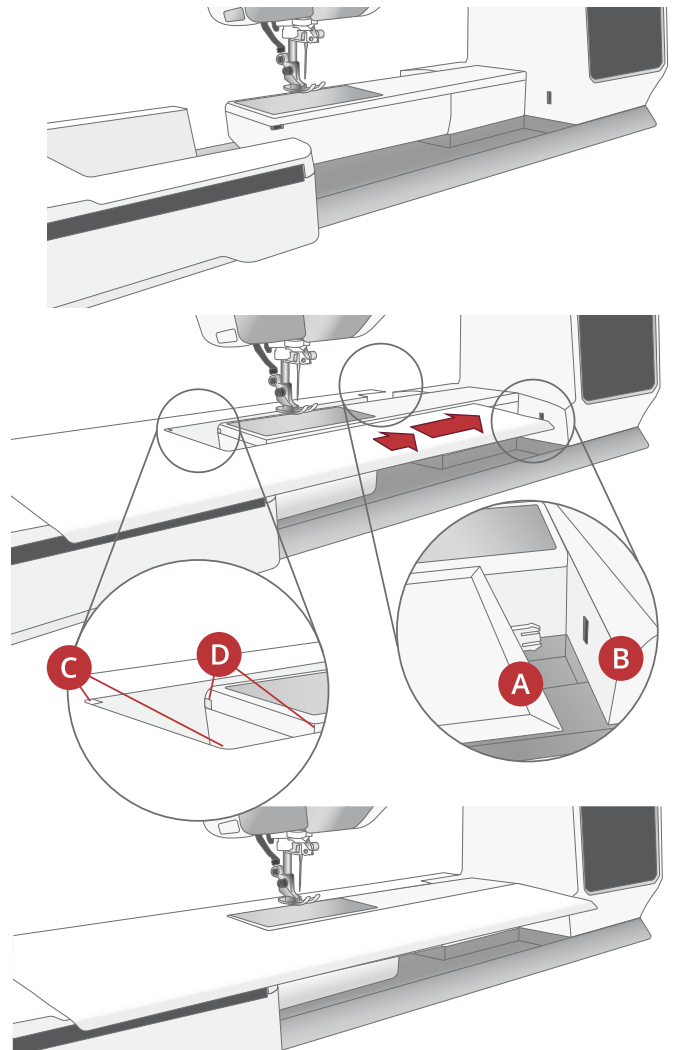

Attach the Large Hoop Support

There are two large hoop supports, one for the front and one for the back of the embroidery unit extension. One side of the hoop supports is slightly more angled than the other, the more angled side should be placed to the left.

1. Fold out the feet on the large hoop support.
2. Align the straighter edge of the hoop support with the right edge of the embroidery unit extension.
3. Place the hooks (placed on the underside) of the hoop support around the embroidery unit extension and push the hoop support onto the extension until it clicks in place. Repeat for the rear hoop support.

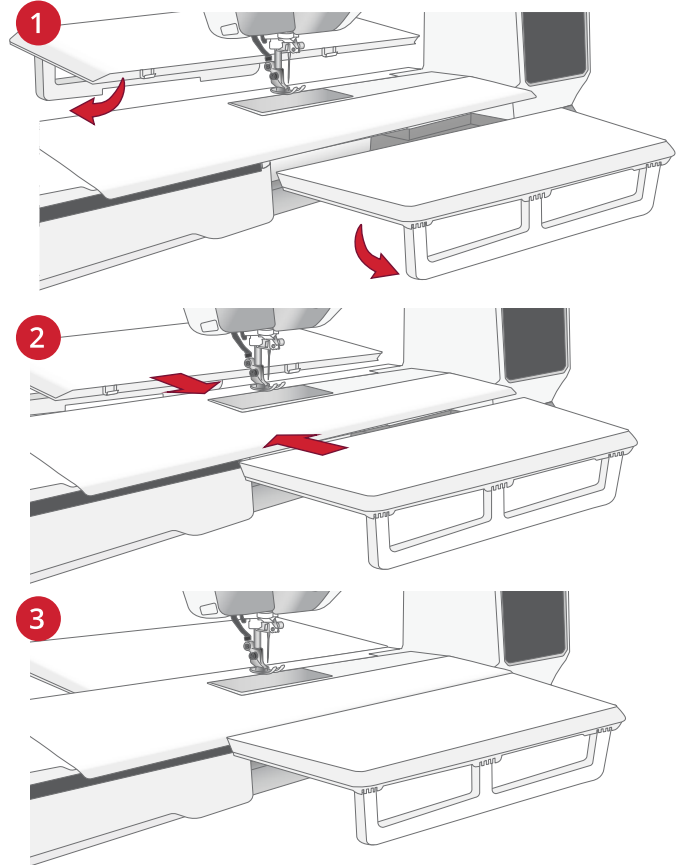

Removing the Embroidery Unit Extension and Large Hoop Support

Note: Remove the large hoop support first, before removing the embroidery unit extension.

Fold in the legs (1) of the large hoop supports and tilt slightly downwards (2) to release it from the embroidery unit extension (3).

Push the embroidery unit extension slightly to the left. Once released, carefully remove it from the free arm and embroidery unit.

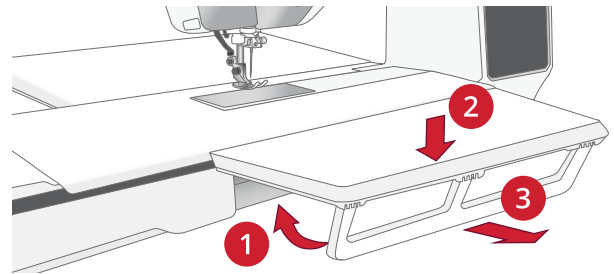

Hooping the Fabric

For the best embroidery results, place a layer of stabilizer beneath the fabric. When hooping stabilizer and fabric make sure that they are smooth and securely hooped.

1. Open the quick release (A) on the outer hoop and loosen the retaining screw (B). Remove the inner hoop. Place the outer hoop on a firm flat surface with the screw on the lower right. There are three small arrows in the center of the lower edge of the outer hoop which will line up with three small arrows on the inner hoop.
2. Place the stabilizer and fabric, with the right sides facing up, on top of the outer hoop. Place the inner hoop on top of the fabric with the small arrows at the bottom edge. If you can see the hoop size in the lower part of the inner hoop, you have attached it correctly.
3. Push the inner hoop firmly into the outer hoop.
A small edge that extends from the inner hoop is designed to nest together with a corresponding edge on the outer hoop. When the inner and outer hoops are properly put together (levelled) they will create a snug fit. This will prevent you from accidentally pushing the inner hoop too far through the outer hoop.
4. Close the quick release (A). Adjust the pressure of the outer hoop by turning the retaining screw (B). The fabric should be taut in the hoop for the best results.

Note: When embroidering additional designs on the same fabric, open the quick release, move the hoop to the new position on the fabric and close the quick release. When changing fabric type, loosen the retaining screw slightly first. This is to avoid high pressure caused by hooping a thicker fabric than previously. Do not force the quick release.

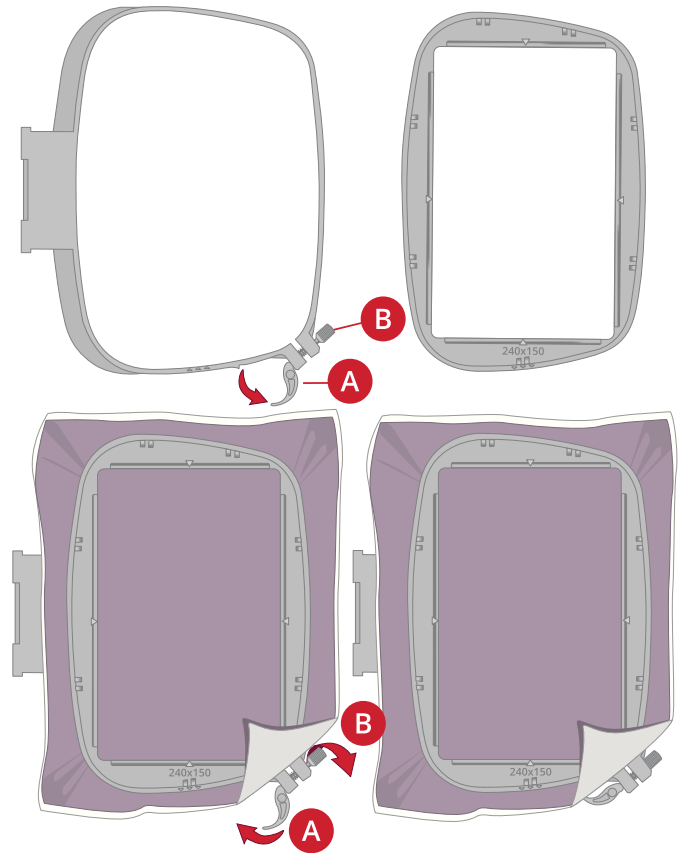

Attaching and Removing the Hoop

The hoop attachment is positioned on the embroidery arm.

Place the hoop in the hoop attachment and carefully push the hoop down until it clicks in place.

To remove the hoop, press the release button towards the embroidery arm.

The hoop will be released and can now be removed.

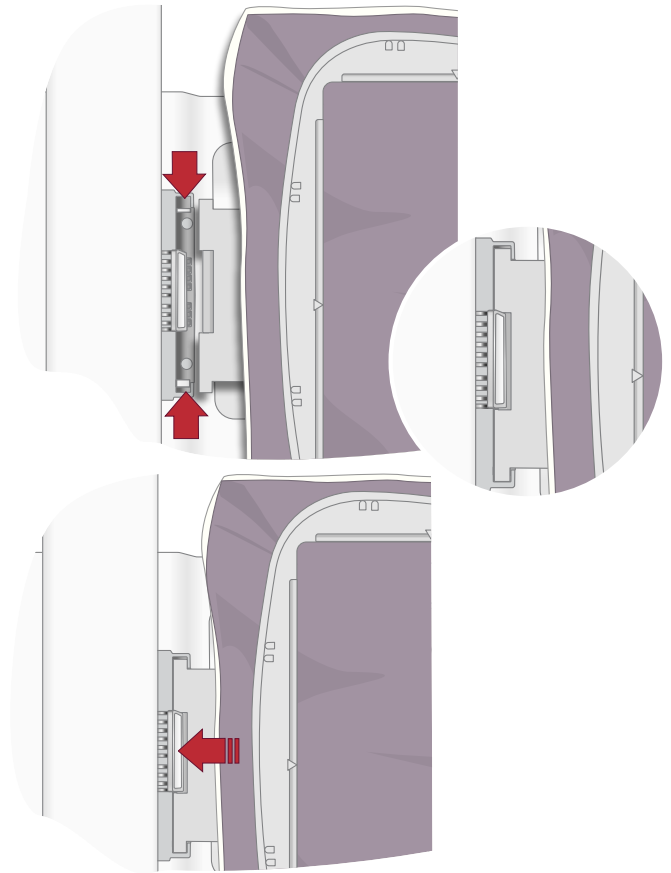

Using the Hoop Adapter

The hoop adapter makes it possible to use older hoops that are not compatible with this embroidery unit.

1. Slide the hoop into the hoop adapter from front to back until it clicks into place.

Hoop your fabric.

2. Place the hoop adapter in the hoop attachment on the embroidery arm and carefully push it down until it clicks in place.

3. To remove the hoop adapter/hoop, press the release button towards the embroidery arm.

The hoop adapter/hoop will be released and can now be removed.

4. To remove the hoop from the hoop adapter, press the grey button on the hoop adapter and slide the hoop towards you.

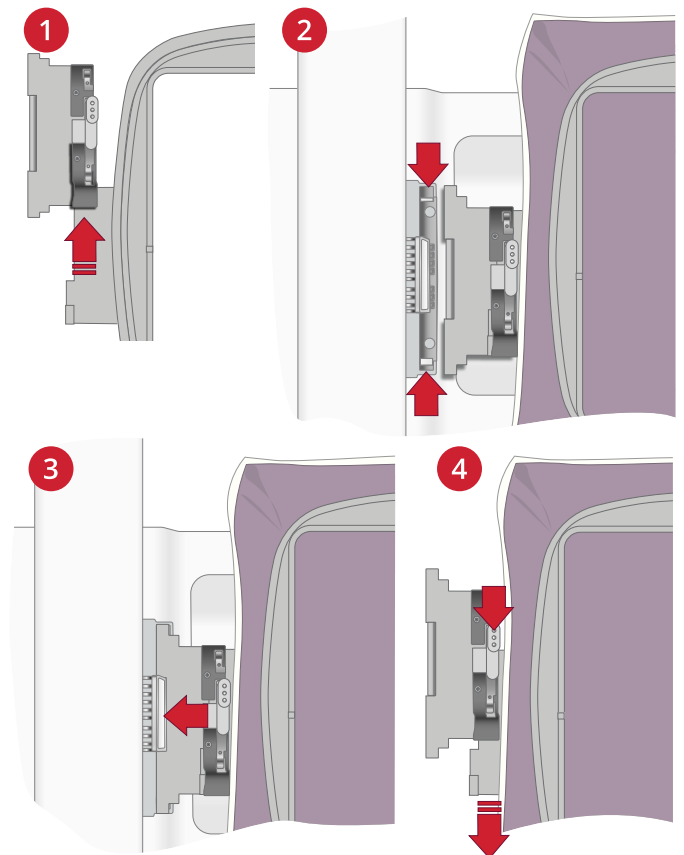

4 The Multi-Touch Screen



Main Functions

Home

The home screen is shown every time you start your DESIGNER EPIC™ 3 machine. The home screen is always accessible through the home button.



mySewnet services

When you're logged in to your mySewnet account you will have access to the cloud storage.

In mySewnet blog you can view the latest product news, sewing instructions and get inspiration.

The machine needs to be connected to the internet to be able to see the feed.

If you have a valid mySewnet subscription, you will also have access to mySewnet library.



JoyOS ADVISOR™

This is where you will find tutorials in both sewing, embroidery, quilting as well as learn more about your machine, available accessories, recommended needles and stabilizers.

When you select any tutorial from the sewing category, the JoyOS ADVISOR™ feature will instantly set the best stitch, stitch width, stitch length, thread tension/portioning, and presser foot pressure for the sewing technique you've chosen.



User's Guide

Here you will find information about how to operate your DESIGNER EPIC™ 3 machine and what the different features of the machine are.

You can look through the user's guide using the table of contents or sorted by an alphabetical index.



Save

Touch to save your stitch, design or sequence at anytime.



Mode Switch

Touch to switch between sewing mode and embroidery edit. You can also start a new sewing or embroidery session.



Quick Help

On almost every function and icon on screen, you can get a short description by using the quick help function.

Touch the question mark icon. Then touch an icon or an area on the screen you want information about.

Some quick helps will refer to the user's guide for more information.



Common Functions

The following functions on the screen are used frequently.

OK

Confirms changes and pop-up messages and returns to previous window.



Cancel

Cancels changes and pop-up messages and returns to previous window.



Touch & Hold

Some buttons have additional functions, marked with an arrow at the lower right corner. To access those functions, touch & hold on the icon for a few seconds.



Smart Toolbox

The smart toolbox is available in the sewing and embroidery area. Touch & hold anywhere in your work area to open the smart toolbox and select the option you want.

The options included in the smart toolbox differ depending on where they are used. For example; duplicate, delete, mirroring and edit.

Customize Your Work Area

The DESIGNER EPIC™ 3 allows you to access the functions you use the most by arranging them as you desire on the screen. Touch & hold the move icon in the center until the control pop's up. Drag and drop it to desired location. Your machine will remember your changes when turning your machine off. Touch the x to close the control. To reset the toolbar to default, use smart toolbox and select reset toolbar.



Move

Top Bar

Several functions are accessible on the top bar, for example mySewnet, home button, quick help, settings and the sewing/embroidery mode toggle.

Note: All functions may not always be available at the same time.



1. Sewing/embroidery mode toggle
2. User's guide
3. Project viewer
4. mySewnet services
5. Home
6. Clock
7. Quick help
8. Update available
9. WiFi
10. Settings

Secondary Top Bar

In the secondary top bar you will see recommendations for your selected stitch, see which features that are currently active, as well as information such as stitch name and speed.

You can expand and collapse by clicking the arrow. Then you will see the full name of all the icons.

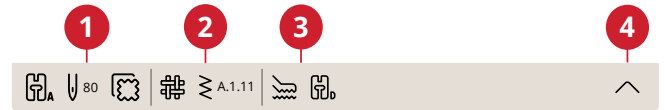

1. Recommendations
2. Information
3. Active features
4. Extended secondary top bar

Recommendations

Recommendations are only available in sewing mode. It shows recommendations for the selected stitch regarding presser foot, IDF System, stitch plate, and/or if stabilizer should be used.

Information

Shows for example selected stitch/total number of stitches in the design depending on which mode you are currently in. It also shows the speed setting for selected stitch/design.

Active Features

This section shows activated features, such as tie-off options, needle down or changes you have made in settings.

5 WiFi & mySewnet Services



WiFi Introduction

Your DESIGNER EPIC™ 3 machine features WiFi, which makes it possible to connect your machine wireless to the mySewnet services.

Getting Started With WiFi

Touch the WiFi button and activate WiFi. Select a network from the list of available networks. If your network is password protected, you will be prompted to enter the password to be able to connect.

Touch the settings icon to see more settings for the network. You can also see the signal strength and if the network is password protected, indicated with a closed padlock.

You can also connect to a network with WiFi in WiFi Settings.

If you do not get any signal or have a low signal strength see Troubleshooting.



- A. *WiFi is disconnected. Connect to a network through WiFi button or WiFi settings.*
- B. *WiFi is connected with low signal strength.*
- C. *WiFi is connected with medium signal strength.*
- D. *WiFi is connected with high signal strength.*
- E. *WiFi is connected but the network does not work properly.*

Firmware Updates

Firmware Update Using WiFi

It is always recommended that you install the latest firmware in your machine.

To be able to get the latest firmware you need to connect to a network using WiFi. When connected, your machine will automatically search for an available firmware update. If the machine has detected that there is a newer firmware available, the firmware update icon will be visible. Touch the icon to download and install the latest firmware.

When the update is completed the machine will restart automatically. Check the firmware version number in settings, Machine Information.



Indication that your machine does not have the latest firmware and that an update is available.

Firmware Update Using a USB Device

Visit the HUSQVARNA® VIKING® website at www.husqvarnaviking.com and find your machine. Here you will find the available updates.

1. Download the update firmware zip file. Unzip the file and copy the file (.clo) to a USB device.

Note: Do not change the name of the file or do not copy the file into an existing folder on the USB device.

Note: Make sure that there is no old firmware update file (.clo) on the USB stick when copying the new firmware update file (.clo). The file name is not unique.

2. Make sure that the machine is turned off. Connect the USB device loaded with the new firmware version to a USB port on your machine.
3. Press and hold the reverse button, located on the front of the machine, and turn on your machine with the ON/OFF button. Release the reverse button when an update icon is shown on the screen.
4. The firmware update will be verified and installed. The machine may restart several times during the update process. Do not turn off the machine.
5. When the update is completed the machine will restart automatically. Check the software version number in settings, Machine Information.

mySewnet Services

The mysewnet.com is the entrance to all the web services that are available when you have a mySewnet account.

mySewnet Cloud

mySewnet cloud is a cloud based service where you can save and access your personal files.

mySewnet cloud offers a simple way to manage and access personal files from different devices.

mySewnet Library

mySewnet Library - a part of our paid subscription service where you can access embroidery software and thousands of embroidery designs. Except from subscribing, you can also make single design purchases.

If you have a subscription, WiFi is connected and you have logged in to your mySewnet account, the mySewnet library menu will be visible in your machine in embroidery edit.

mySewnet Blog

In mySewnet blog you can view the latest product news, sewing instructions and get inspiration!

The machine needs to be connected to WiFi to be able to see the feed.



- A. Signed in to mySewnet cloud.
- B. Synchronizing files with the mySewnet cloud.
- C. Cannot synchronize with the mySewnet cloud. Check the used space in the mySewnet cloud.
- D. Not signed in to the mySewnet cloud.

Project Creator

mySewnet Project Creator is a tool, where you can turn your favorite sewing or embroidery projects into shareable step-by-step instructions.

Free mySewnet Embroidery Software (PC and MAC)

A computer software package is available for your machine. It adds the following features:

- Basic Embroidery Software – Open your embroidery designs, copy and paste, combine and color sort. Export in the format you need for your machine. Read more details on mysewnet.com
- Computer plug-in to handle embroidery designs: viewing designs as thumbnail images, reading different embroidery file formats, add trim commands and more. Visit mysewnet.com to create a mySewnet account and download the software.

More information and detailed installation instructions are available on the download page at mysewnet.com.

Apps

There are several apps available to download for free to your mobile device. Visit mysewnet.com to find and read more about our selection of apps. You can download them directly in the App store and Google play.

6 Home Screen



Home Screen— Overview

The home screen is filled with guidance, inspiration and help, making sure that you get the assistance you need in order to utilize your machine's full potential.

Here you'll find the JoyOS ADVISOR™ feature, which includes a large amount of different tutorials to choose from. JoyOS ADVISOR™ will set the best stitch, stitch width, stitch length, thread tension/portioning, and presser foot pressure for the technique you've chosen

If you're in need of inspiration on what to create, read the mySewnet blog, which is updated frequently.

Read your user's guide directly on screen for instant help.

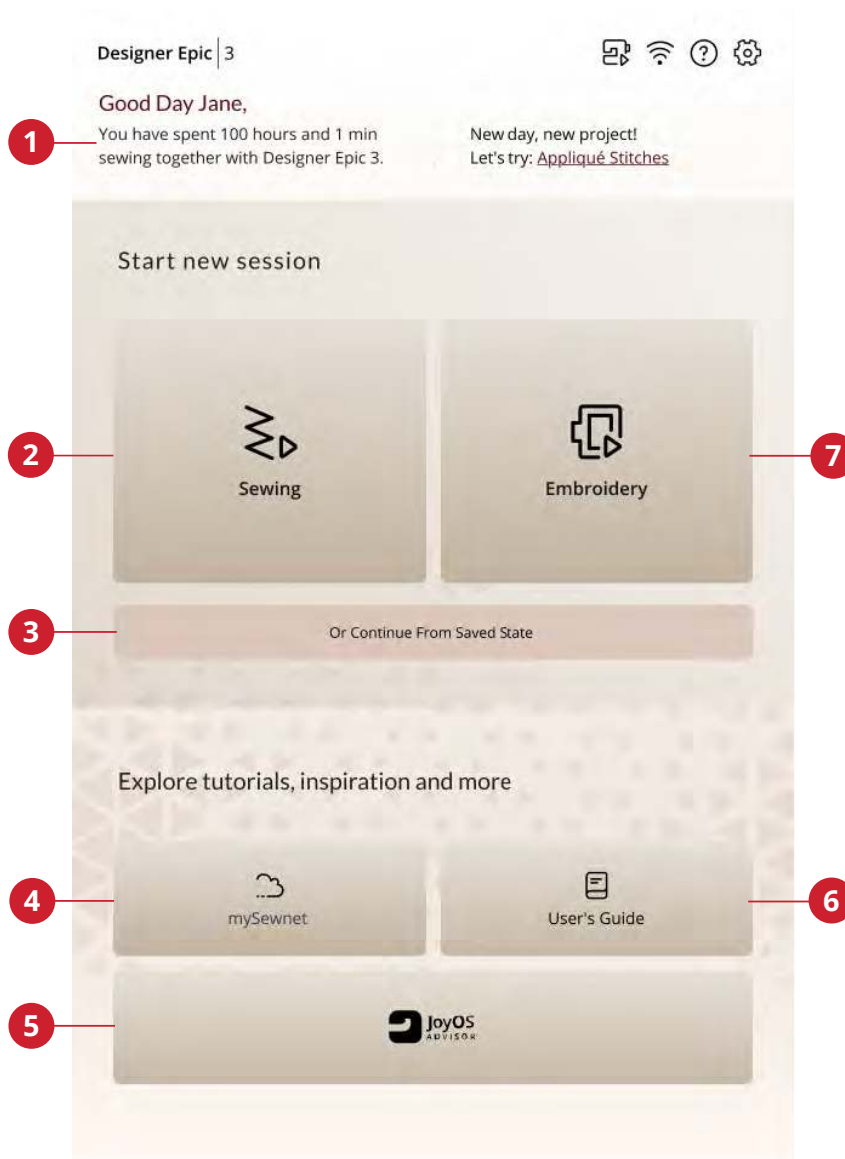

- | | | |
|-------------------------------|-----------------------------------|-----------------|
| 1. User profile | 4. mySewnet blog | 7. User's guide |
| 2. Sewing — start new session | 5. JoyOS ADVISOR™ feature | |
| 3. Continue from saved state | 6. Embroidery — start new session | |

Edit Machine Nickname

On your home screen you can see the name of your machine.

This can be useful when owning more than one machine to distinguish one machine from another. The name will be shown on the screensaver.

You can change your machine's nickname in settings.

User Profile

When you are signed in to your mySewnet account, your user name will be shown. You will receive information on, for example, how much time you've spent sewing on your machine.

Sewing/Embroidery — Start New Session

Click here if you want to go to sewing mode or embroidery edit directly.

Continue from Saved State

When saving current state, all your adjustments are stored and you can continue later by touching “continue from saved state”.

Note: You can only have one current state saved at a time.

mySewnet™ Blog

In mySewnet blog you can view the latest product news, sewing instructions and get inspiration!

The machine needs to be connected to WiFi to be able to see the feed.



User's Guide

Here you will find information about how to operate your DESIGNER EPIC™ 3 machine and what the different features of the machine are.

You can look through the user's guide using the table of contents or sorted by an alphabetical index.



JoyOS ADVISOR™

You have a large amount of different tutorials to choose from, which step-by-step will guide you through text, illustrations and animations.

You can learn a lot of different techniques within sewing, quilting and embroidery. If you need help with the basics of your machine, for example how to; thread the machine, wind the bobbin or make your machine ready for embroidery, there are tutorials for that as well. You can even find tutorials on how to use your accessories.

Select your fabric type and choose from a wide selection of available sewing techniques. The JoyOS ADVISOR™ feature will instantly set the best stitch, stitch width, stitch length, thread tension/portioning, and presser foot pressure for the technique you've chosen.

Use the search function to search within the JoyOS ADVISOR™.

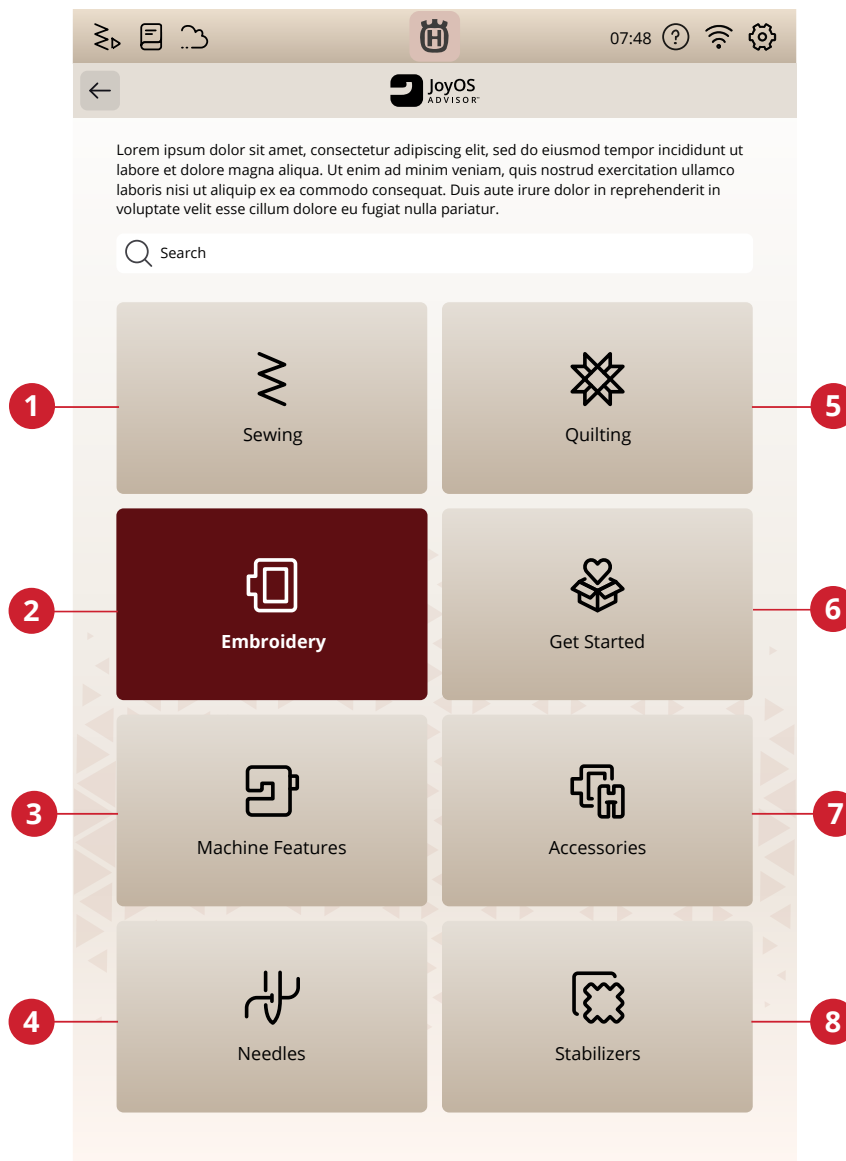

1. Search
2. Sewing
3. Embroidery

4. Machine features
5. Needles
6. Stabilizers

7. Accessories
8. Get started
9. Quilting

Sewing

When loading a sewing technique the machine will select the best stitch and settings for your chosen fabric and project. Depending on which choices you make, your JoyOS ADVISOR™ feature will recommend the most suitable sewing techniques.



Fabric Selection

Start your sewing by selecting the fabric that you will use.

After selecting a fabric, touch a sewing technique group and the JoyOS ADVISOR™ feature will recommend sewing techniques suitable for your fabric.

Suggested fabrics for each fabric group you can choose from are listed below.

Note: Some fabrics have excess dye which can cause discoloration on other fabrics or on your sewing machine. This discoloration may be very difficult or impossible to remove.

Fleece and denim fabric, especially red and blue, often contain excess dye.

If you suspect that your fabric/ ready-to-wear garment contains a lot of excess dye, always pre-wash it before sewing/ embroidering to prevent discoloration of your machine.

Woven or Knit

The difference between woven and knit fabric is the way the threads are put together. Woven fabrics are made of two thread system, warp lengthwise and weft crosswise, that intersect at right angles. A knit fabric is made of one thread system with interlaced stitches. A knit fabric usually has stretch.

As a general rule, select woven in the JoyOS ADVISOR™ feature for stable fabrics that have no stretch and stretch for fabric that have stretch.

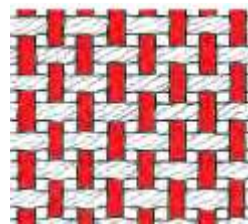

Woven fabric

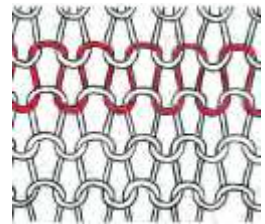

Knit fabric

Woven Fabrics

Woven Light: Chiffon, organza, batiste, challis, crepe de chine etc.

Woven Medium: Calico, quilting fabrics, crepe, broadcloth, velvet etc.

Woven Heavy: Denim, tweed, canvas, terrycloth etc.

Stretch Fabrics

Stretch Light: Tricot, single knit jerseys etc.

Stretch Medium: Sweater knits, double knit, velour, swimwear etc.

Stretch Heavy: Sweater knits, fleece etc.

Leather and Vinyl

For suede and leather. Leather is animal skin with the coat (fur) removed. Leather can be smooth or sueded and has some give.

For vinyl, faux leather and suede. Vinyl is a synthetic material which often has a woven wrong side. Vinyl can be smooth or patterned and some vinyls have stretch.

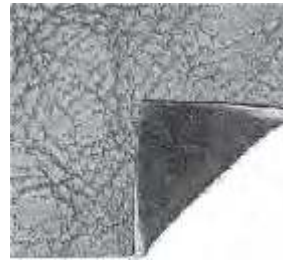

Leather fabric



Vinyl fabric

Quilting

Quilting is a method of stitching layers of material together. There are several different quilting techniques, we will walk you through some of the most common ones.



Embroidery

Embroideries are embellishments that can be made in endless ways.

We have a wide range of embroidery techniques for you to try out, for example cutwork, appliqué and yarn embellished embroidery to name a few.



Get Started

In this section you will find help that has to do with the basics of the machine such as threading the machine, how to engage and disengage the IDF System and prepare your machine for embroidery.



Advanced Features

Your machine has a lot of great features which enables you to create unique stitches and sequences, shape your texts and much more.

All tutorials in this category will walk you through all of these features included in your machine.



Accessories

There is a wide assortment of HUSQVARNA® VIKING® accessories that are compatible with your machine.

The tutorials in this category will show how to use accessories both for sewing, embroidery and quilting.



Needles

In this category you can read more about all the different types of HUSQVARNA® VIKING® needles that you can choose from.



Stabilizers

When embroidering, the use of a stabilizer is necessary. HUSQVARNA® VIKING® offers a selection of different types of stabilizers, depending on your need.



In this category you can find information about all available stabilizers in our assortment and when they are recommended to be used.

- **Cut-a-Way:** Cut-a-Way stabilizers are stabilizers that need to be cut away by using scissors. It will stay on the fabric to make the embroidery more stable.
- **Batting:** Use batting between your top fabric and backing to add body to your project.
- **Water soluble stabilizer:** The stabilizers in this category are stabilizers that dissolves in water. They are very useful when embroidering lace and cutwork embroideries.
- **Specialty:** In this category you will find stabilizers for special uses.
- **Tear-a-Away:** Tear-a-way stabilizers are temporary stabilizers. They are easy to remove after embroidering

Project Viewer

When loading a tutorial from the JoyOS ADVISOR™ feature it will be shown in the project viewer.

In the project viewer you can change the fabric that you will use. The stitches loaded through the project are set to fit your selected fabric.

You can enlarge the images shown by touching it.

Load the recommended stitch for the loaded technique by touching the stitch in the viewer.

In every tutorial, content such as stitches and embroideries, are filtered out based on the chosen technique.



1. *Cancel*
2. *Minimize*
3. *Detach/move*
4. *Instruction/content*
5. *Decrease/increase text size*
6. *Expand*
7. *Step backward/forward*
8. *Start tutorial*

How to Play Animations

In the video player you can pause, rewind, fast forward, set the animation on repeat and turn full screen mode on/off. Touch cancel to close the video player. Touch & hold on rewind to start the animation from the beginning.

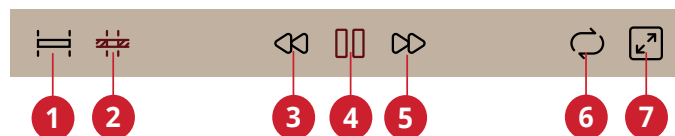

1. *Watch full animation*
2. *Watch clip*
3. *Rewind (touch & hold to go to beginning)*
4. *Play/pause*
5. *Fast forward*
6. *Repeat on/off*
7. *Full screen on/off*

7 Sewing



Sewing Mode – Overview

In sewing mode you can select stitches, adjust and sew them. Your selected stitch will be shown in actual size in the stitch field.

Use the Stitch Creator™ feature and sequence to create your own stitches and sequences.

You will see active features and be given recommendations based on selected stitch.

Note: All symbols and options will not be shown at the same time.

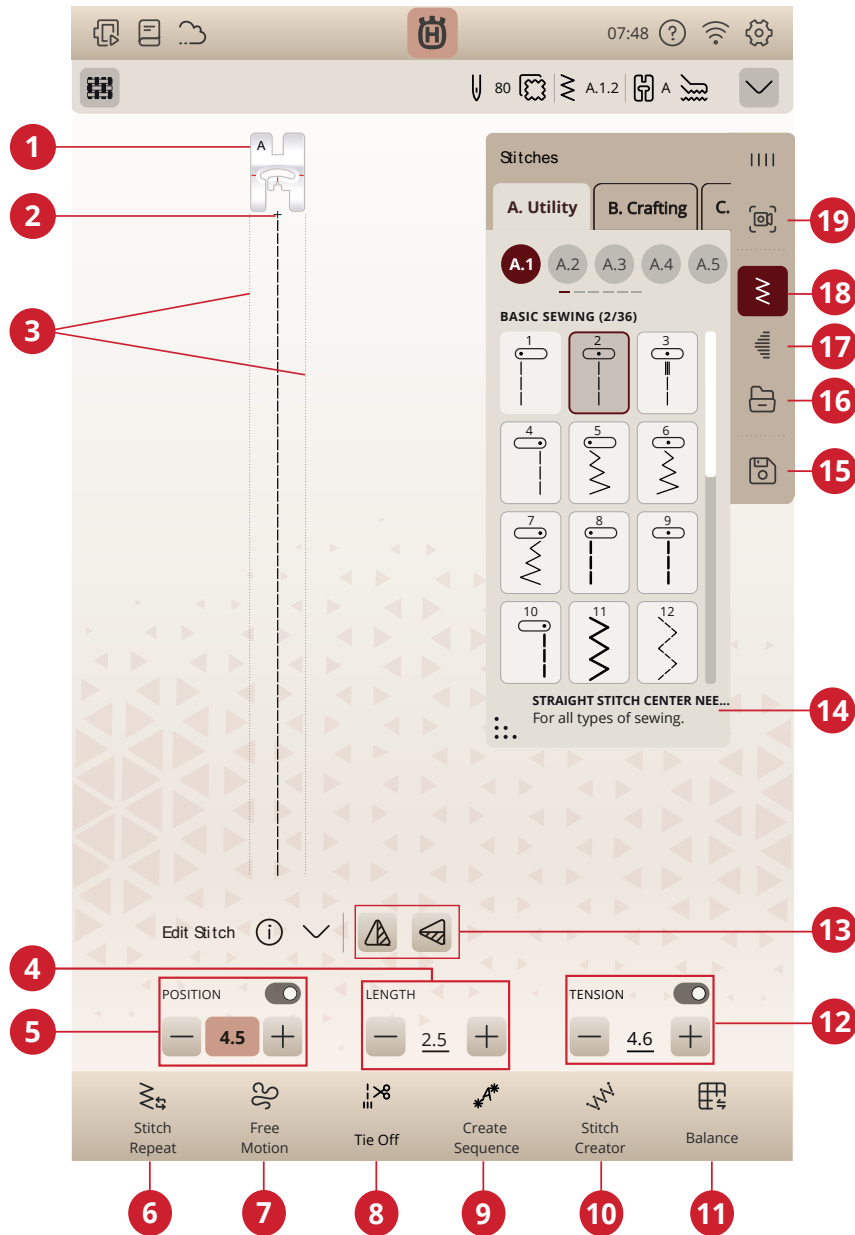

- | | | |
|------------------------------------|--|------------------|
| 1. Recommended presser foot | 9. Sequence | 15. Save |
| 2. Stitch start | 10. Stitch Creator™ | 16. File manager |
| 3. Maximum stitch width indication | 11. Balance | 17. Tapering |
| 4. Stitch length/stitch density | 12. Thread portioning/thread tension/
presser foot pressure | 18. Stitch menu |
| 5. Stitch width/stitch positioning | 13. Mirror side to side/mirror end
to end | 19. Projection |
| 6. Stitch repeat | 14. Stitch information | |
| 7. Free-motion options | | |
| 8. Tie-off options | | |

Load a Stitch

Touch the stitch menu and select the desired stitch. Available stitch categories are listed horizontally, swipe to see more categories. All categories have sub categories. When you select a stitch, it will automatically be loaded and you get a short description of the selected stitch. The select stitch window can be expanded if you touch and drag the triangle in the lower corner.

From the file manager you can load stitches or sequences that you have saved in your mySewnet cloud folder or on a USB device. In file manager you will see all your saved files e. g. stitches, designs and fonts. Learn how to organize your files in file manager.

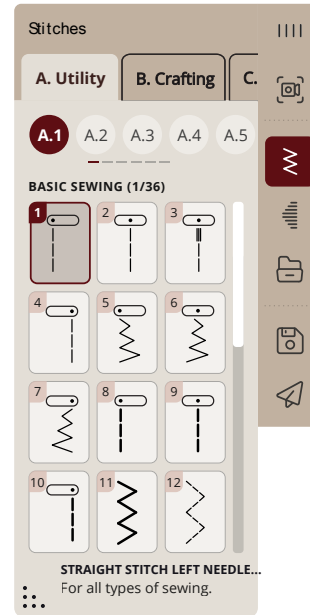

Projection — Overview

Use the projection to preview your selected stitch on the fabric and overlay helpful guidelines as a support when sewing.

Note: The projection preview of stitches are made in front of the needle, therefore, stitches that are sewn backwards (such as buttonholes) or sideways cannot be projected properly.

You can turn on the projection by activating it in the projection menu on screen.

The projection can assist you with the following:

- preview of the stitch underneath the needle. You can see in actual size how the selected stitch will turn out on your project.
- activate a grid adjustable in size, color and angle to meet your need of exactness when sewing.
- guide you when sewing, using one or two guidelines. Straight or angled in any color.

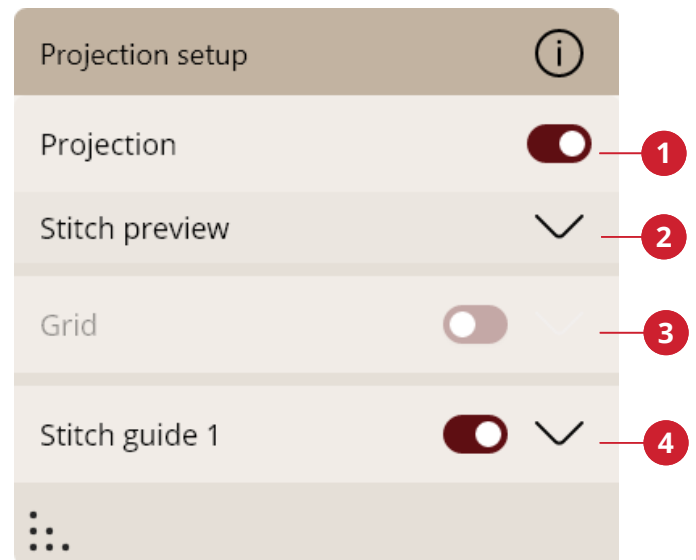

1. Projection off/on

2. Stitch preview

3. Grid options

4. Stitch guide

Projection Options

If you want the machine to light up the sewing area projection in a special color, you can change the background color.

You can also adjust the level of brightness of the projection.



1. *Background color*
2. *Brightness*

Stitch Preview

The stitch is shown in actual size and projected on your fabric in relation to the needle.

For a maximum visibility against your chosen fabric, or to simulate a special thread, you can change the color of the stitch preview.

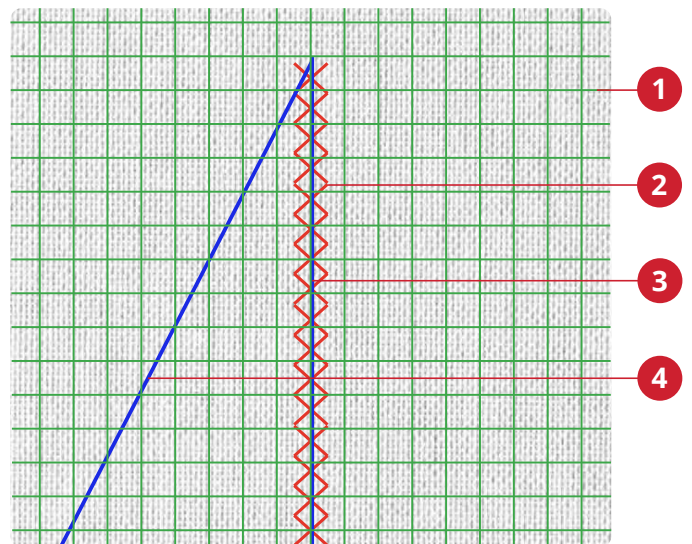

1. *Grid*
2. *Preview of selected stitch*
3. *Stitch guide 1*
4. *Stitch guide 2*

Grid

For a maximum visibility against your chosen fabric, you can change the grid color.

The grid can also be moved and angled.

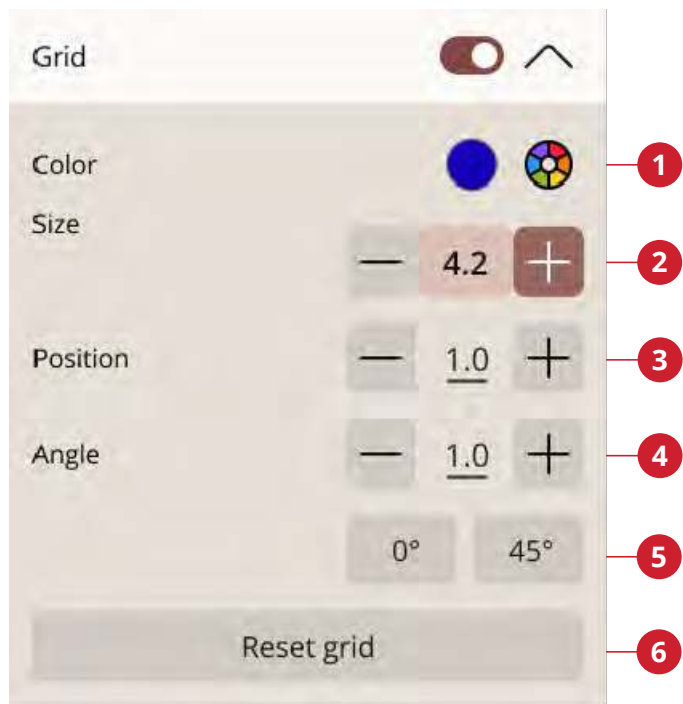

1. *Grid color*
2. *Grid size*
3. *Position*
4. *Angle*
5. *Preset angles*
6. *Reset grid*

Stitch Guidelines

For maximum visibility against your chosen fabric, you can change the color of the guidelines.

Set the width and length (max 100mm) of your guideline.

The guidelines can be moved both vertically and horizontally.

The angle of the guideline can also be changed.

You can have two different guidelines with different settings.

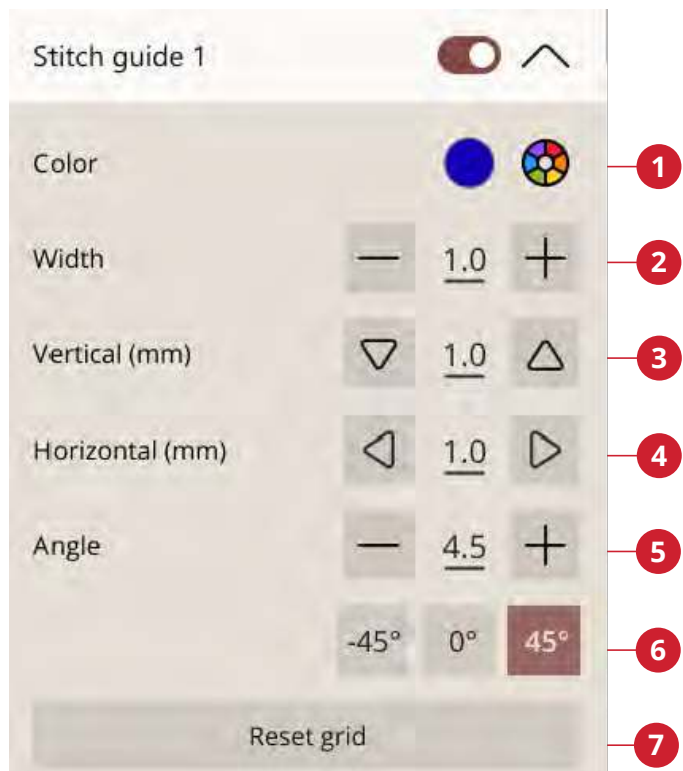

1. *Color*
2. *Width*
3. *Vertical position*
4. *Horizontal position*
5. *Angle*
6. *Preset angles*
7. *Reset*

Information and Sewing

Recommendations

Recommendations are shown in the secondary top bar. Your machine automatically gives you recommendations depending on the selected stitch and current setting.

The following recommendations can be shown:

Presser foot, IDF System and stabilizer. The straight stitch plate recommendation will be shown when a free-motion option is selected with a straight stitch. When an optional presser foot is recommended, the icon for optional presser foot will be visible on the screen.



- 1. *Presser foot recommendation*
- 2. *IDF System recommendation*
- 3. *Stabilizer recommendation*
- 4. *Straight stitch plate*
- 5. *Needle recommendation*
- 6. *Optional presser foot*

Presser Foot Recognition

The presser foot recognition feature can recognize the majority of HUSQVARNA® VIKING® original presser feet. The presser foot recognition system will detect which presser foot is attached to the machine. If the presser foot that is recommended for the selected stitch (A) differs from the one predicted to be attached (B), your machine will alert you with a message in the information area. You are also notified if the system predicts that your presser foot is attached incorrectly (C).

Note: The performance of the presser foot recognition feature can be affected by eventual alterations of a presser foot's appearance; due to room lighting, fabric reflectivity properties, position fluctuations, obstructions or physical alterations of the presser foot's surfaces.



- A. *Recommended presser foot*
- B. *Attached presser foot predicted by the neural network*
- C. *Presser foot is not attached correctly*

Stitch Settings

Your machine will set the recommended settings for each selected stitch. You can make your own adjustments to the selected stitch. The changes will only affect the selected stitch and will be reset to default when selecting another stitch or turning your machine off. To save your adjusted stitch, touch save.

The controls available on the screen will change depending on what stitch or sequence is loaded. Some stitches have more than one control, and an alternative switch bar will appear. Touch the alternative switch bar to change to an alternative control for a different stitch setting. Touch it again to change back to the previous control. The different stitch settings are described below.

If you need an explanation of the icons, touch the drop down arrow to open a panel with description of the icons.

Note: When trying to exceed minimum or maximum settings for width and length, a warning sound will be heard. The default setting is always shown in black numbers.

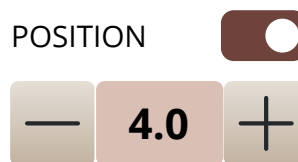

Example of stitch setting control

Stitch Width

Increase or decrease the stitch width using – and + in the control. The number shows stitch width in mm/inch.

Changed stitch position may limit the stitch width adjustments.

Stitch Positioning

On certain stitches with a width less than 9 mm it is possible to change the stitch position. Use – to move the stitch to the left and + to move the stitch to the right. The number shows the needle start position in mm in relation to center needle position. The machine has a maximum of 37 needle positions (for a straight stitch).

The stitch position can only be changed to the limit of the maximum stitch width. Changing the stitch positioning will also limit the stitch width adjustments.

Stitch Length

Increase or decrease the stitch length using – and + in the control. The number shows the set stitch length in mm/inch. If lengthening a zigzag stitch or a decorative stitch, the entire stitch will be stretched out. If lengthening a stitch where the density can be adjusted, the entire stitch will be longer but the density of the satin stitches will remain the same.

Stitch Density

The stitch density control adjusts the density (the distance between the individual satin stitches that make the entire stitch). The density does not affect the actual length of the entire stitch.

Touch – to increase the density. Touch + to decrease the density. The number shows the distance between satin stitches in mm/inch.

Tip: Decrease the density to get different visual effects e.g. when using speciality threads.

Mirroring

To mirror a stitch or stitch sequence sideways, touch mirror side to side. To mirror a stitch or stitch sequence lengthwise, touch mirror end to end.

Tip: Use the smart toolbox to open a shortcut for mirroring.

Note: Some stitches e.g. buttonholes cannot be mirrored.



Mirror side to side/mirror end to end

Buttonhole Slit Length

Set the buttonhole slit length by using - to decrease and + to increase when sewing a buttonhole with the Sensor One-Step Buttonhole Foot.

Button Stitch Repetition

When sewing a button, you can set the number of stitch repeats. Use the – or + in the control to decrease or increase the number of stitch repeats.

deLuxe™ Stitch System

The *deLuxe™* stitch system has two ways to control the upper thread: thread portioning and thread tension. To get the best sewing result it will automatically use thread portioning when possible. Thread portioning automatically and continuously measures the fabric thickness to portion the correct amount of thread for the selected stitch.

When thread tension is used, the tension discs will keep the correct amount of tension on the upper thread. Some special techniques may require the use of thread tension. Deselect the *deLuxe™* stitch system in sewing settings to ensure that thread tension is engaged. When the *deLuxe™* stitch system is selected, the control visible in sewing mode will change between thread portioning and thread tension depending on the current settings and the loaded stitch.

Use the thread portioning/thread tension control to adjust the balance between needle thread and bobbin thread, e.g. decrease when using metallic thread and increase when using heavy weight thread. Make a few tests with different settings on a scrap piece of the fabric you are going to use and check the balance between the upper thread and the bobbin thread.

Note: When changing the value of the thread portioning/ thread tension setting, the changes only affect the selected stitch. Your changed settings will be reset to default when selecting another stitch.

Tip: Increase the thread portioning/ thread tension setting for best results when sewing on denim fabric with thick threads.

Adjust Thread Tension/Thread portioning

For the best stitch appearance and durability make sure the threads meet evenly between the two fabric layers.

If the bobbin thread is visible on the top side of the fabric, the thread tension/thread portioning is too tight. Reduce the thread tension/thread portioning.

If the upper thread is visible on the back side of the fabric, the thread tension/thread portioning is too loose. Increase the thread tension/thread portioning.

For decorative stitches and buttonholes the upper thread should be visible on the back side of the fabric.

Make a few tests on a scrap piece of the fabric you are going to use and check the tension.

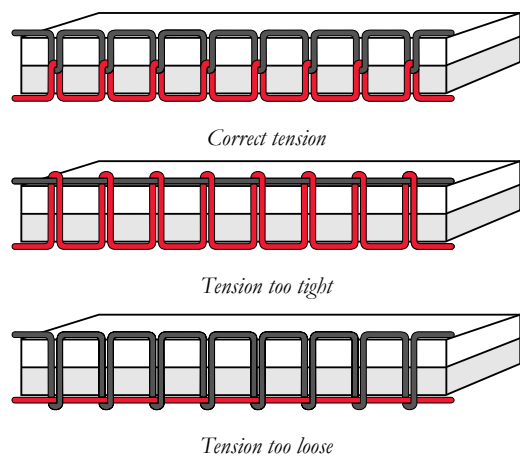

Presser Foot Pressure

Touch + to increase or - to decrease the pressure of the presser foot on the fabric.

EXCLUSIVE SENSOR SYSTEM™

Thanks to the EXCLUSIVE SENSOR SYSTEM™ feature, the presser foot automatically and continuously senses and adjusts as you sew any thickness of fabric for perfect even feeding.

Go to sewing mode to see the actual setting of the sensor foot pressure for the selected fabric and adjust the presser foot pressure.

Balance

When sewing on special fabrics or doing a special technique, the balance may need to be adjusted.

Start by sewing the stitch on a piece of scrap fabric. Touch the balance icon. Change the preview on the screen to match your sewn sample by using the + and - in the controls. When you sew again, the balance will be corrected.



Balance

Free Motion Options

All stitches on your machine can be sewn in free-motion to create unique effects.

Choose between different free-motion options.

For all free-motion sewing the feed teeth will lower automatically and the fabric must be moved manually.

When sewing free motion with a straight stitch, use the straight stitch plate for best result. Read about how to change to straight stitch plate.

Note: Make sure that the IDF System is disengaged.

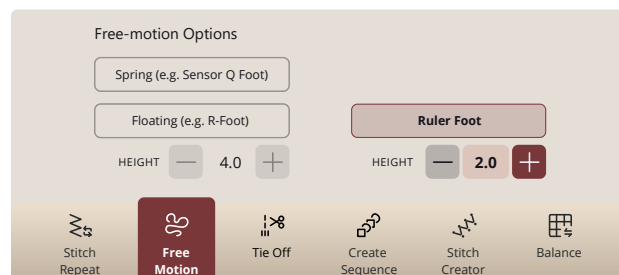

Free Motion Spring

Select free motion spring to use spring feet, e.g. the Sensor Q-Foot. The feed teeth will lower automatically.

A spring foot will raise and lower with each stitch to hold the fabric on the needle plate while the stitch is being formed.

When sewing, you need to move the fabric manually.

Sensor Q-Foot is recommended for all free motion sewing except when using specific techniques or accessories that do not support the use of Sensor Q-Foot.

Tip: There is an optional open toe free motion spring foot that can be purchased at your local authorized retailer.

Free Motion Ruler Foot (Optional)

Select free motion ruler foot to use the optional free motion ruler foot. The feed teeth will lower automatically.

The presser foot floats over the fabric while sewing.

Free Motion Floating

Select free motion floating to use floating feet, e.g. the R-Foot. The feed teeth will lower automatically.

When sewing at low speed the presser foot will raise and lower with each stitch to hold the fabric on the needle plate while the stitch is being formed. At higher speed, the presser foot floats over the fabric while sewing. The fabric must be moved manually.

Skipped stitches can occur if your fabric moves up and down with the needle as you are stitching. Lowering the presser foot height will reduce the space between the presser foot and the fabric and eliminate the skipped stitches.

Note: Be careful not to reduce the presser foot height too much. The fabric must still move freely under the presser foot.

To adjust the presser foot height in free motion floating mode, touch the presser foot height control to make adjustments.

Note: If free motion floating is activated, do not use a spring action foot, as this might damage the presser foot.

Note: Activate stitch width safety if the presser foot requires it.

Tip: There are optional free motion floating feet that can be purchased at your local authorized retailer.

Tie-Off Options

These options allow you program tie-off at the beginning and at the end of a stitch. It is also possible to program thread cut at the end of a stitch.

When touching the tie-off icon, three options open to let you select different functions; tie-off beginning, tie-off end and thread cut.

Your settings are shown under active features.

Note: For immediate tie-off, use the tie-off button, found on the front of the machine.



Sewing with Tie-Off Options selected

- The tie-off beginning will be performed as soon as you start to sew.
- Press the reverse button to perform tie-off end. The action indicator lamp will be lit to indicate that the machine will finish the stitch and do the tie-off.
- When a thread cut is programmed, the machine will automatically cut the threads after performing a stitch. The needle and presser foot will raise.

Note: Stop sewing and press the reverse button twice to activate reverse sewing. The reverse indicator lamp will be lit. No tie-off will be performed.

Press the reverse button when sewing in reverse to activate tie-off end. The action indicator lamp will be lit.

To go back to sewing forward, stop sewing in reverse and press the reverse button. No tie-off will be performed.



Tie-off beginning/ tie-off end



Reverse button

Save Stitch

You can choose to save your file to the mySewnet Cloud folder or to a USB device (only visible as a selection when an USB device is connected). Previously saved designs, stitches, sequences and/or fonts are shown.

Read about organizing your saved stitches in File Manager.

When saving current state, adjustments are stored and you can continue later by touching “Continue from Saved State” at the home screen.

Note: You can only have one current state saved at a time.



Save button

Sewing Programs

These techniques may require some special presser feet and accessories.

Stitch Repeat

Stitch repeat makes it possible for you to program an exact seam length, it also lets you decide how many repetitions of a stitch you want to sew.



Stitch repeat

Patchwork Program

The patchwork program makes it possible for you to program an exact stitch length that can be sewn repeatedly. This is very useful when quilting.

To program a seam length, touch stitch repeat and select patchwork program. Sew until you reach your desired seam length and press the reverse button while sewing. The reverse indicator on the machine will be lit until the current repetition is finished. This will set the length of the seam.

Once you have set the length of a seam, the patchwork program is inactive. The single stitch program is now activated instead. The number of stitch repetitions included in your programmed patchwork seam is shown. Adjust the length of the seam, by increasing/decreasing the number of repetitions using the +/- controls.

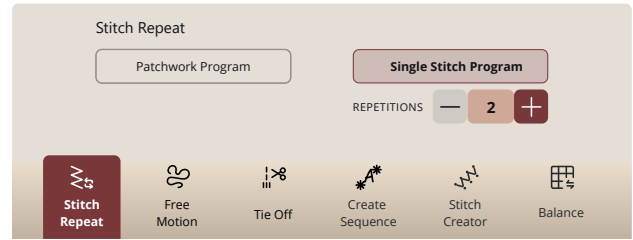

Single Stitch Program

The single stitch program lets you decide how many repetitions of a stitch you want to sew. Touch stitch repeat and select single stitch program. Set the number of repetitions using the +/- controls. The machine will stop automatically when the repetitions are sewn.

Combining Programs

Combining tapering and patchwork programs makes it possible to repeat a tapered seam with the same length.

Activate tapering . Sew your desired length. When the reverse button is pressed the reverse indicator will increase the light until the end taper and last repetition of the stitch is finished.

The seam is now programmed and the single stitch program is activated. When you start sewing again the seam will automatically be repeated with the same length.

The number of repetitions are shown. Adjust the length of the seam, by increasing/decreasing the number of repetitions using the +/- controls.

Note: The tapering is included in the repetitions shown on the screen.

Sewing Techniques

In JoyOS ADVISOR™ you can find all tutorials for the sewing techniques mentioned below.

In basic sewing techniques you will find the most commonly used sewing techniques. When you choose one of the basic sewing techniques, the recommended stitch for the chosen fabric is automatically loaded.

Seam

A seam sews two pieces of fabric together with a seam allowance that will usually be pressed open. In most cases, edges of the seam allowance are finished with an overcast stitch before sewing the seam.

Seams in stretch fabric must stretch with the fabric. The stretch stitch makes a stretchy seam that is suitable for sewing together pieces of light stretch fabric.

Your JoyOS ADVISOR™ feature will select the best stitch length and stitch width for the fabric weight and recommend the presser foot and needle.

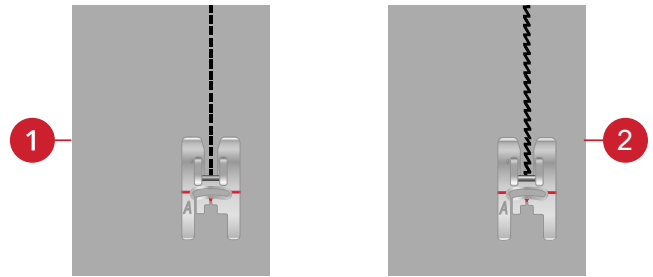

1. *Straight stitch*

2. *Stretch stitch*

Overcast

Overcast fabric edges to prevent fraying and to help them lay flat. It is easier to overcast before the garment is sewn together.

Your JoyOS ADVISOR™ feature will select the best stitch length and stitch width for the fabric weight and recommend the presser foot and needle.

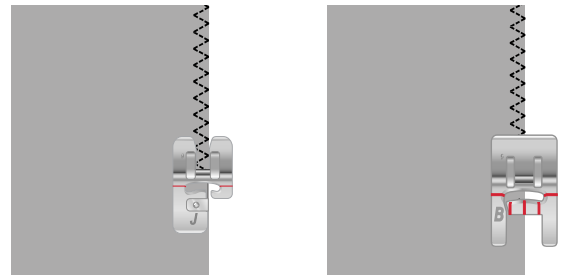

Seam and Overcast

The seam/overcast stitch sews the seam and overcasts the edges all at one time. The seam/overcast technique is perfect for stitching ribbed neckbands and cuffs. There are a number of different seam/overcast stitches in your machine.

Your JoyOS ADVISOR™ feature will select the best one for your fabric and make all adjustments automatically and recommend the presser foot and needle.

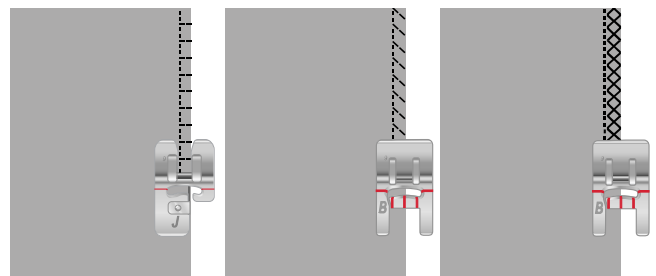

Baste

Basting is temporary stitching for fitting garments, gathering and marking. The JoyOS ADVISOR™ feature automatically sets a long stitch length and reduces the tension so the threads are easy to remove or to pull for gathering.



Blind Hem

The blind hem creates an invisible hem on garments. There are two types of blind hems; one is recommended for medium to heavy fabrics, the other for stretch. The blind hem is not suggested for light weight fabric, leather and vinyl.

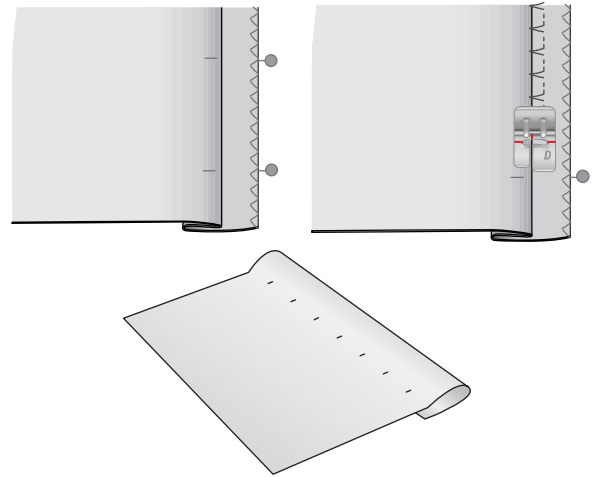

Hem

The hem technique on your JoyOS ADVISOR™ feature will select the visible or topstitch hem that is best for your fabric weight and type. For woven fabric, leather and vinyl a straight stitch is selected. For stretch fabrics, stitches that can stretch are selected.

Buttonholes

The JoyOS ADVISOR™ feature will select the best buttonhole and stitch settings for your chosen fabric. Fabric should be interfaced and/or stabilized where buttonholes are to be sewn.

Tip: In your accessory tray there is a special hook where you can hang your Sensor One-Step Buttonhole Foot.

Sew a test buttonhole on a fabric scrap to verify the desired length of the buttonhole.

Measure the desired distance from the fabric edge and then add the length of your buttonhole.

When sewing, place the finished fabric edge with stabilizer underneath the presser foot, facing away from you.

Use the marking on your fabric to position the starting point.

Manual Buttonhole

Manual buttonholes are recommended for woven heavy fabric. To sew a manual buttonhole, use the buttonhole foot C.

1. Sew the first column as long as you want the buttonhole to be.
2. Touch the reverse button. The machine sews the bartack and the second column.
3. When the columns are aligned, touch the reverse button to sew the second bartack.
4. Touch the STOP function to sew the same length repeatedly.

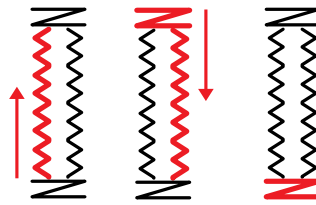

Sewing direction for buttonholes without satin stitches or satin stitch buttonholes sewn with presser foot C.

Automatic Buttonhole

When sewing buttonholes on woven light, woven medium, stretch light or vinyl fabric you can use the Sensor One-Step Buttonhole Foot. The Sensor One-Step Buttonhole Foot will sew automatic buttonholes. Read about how to attach the Sensor One-Step Buttonhole Foot.

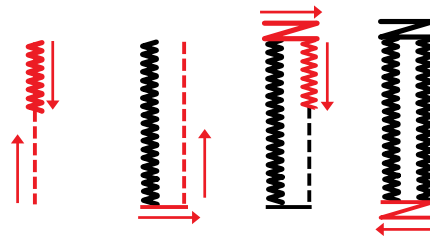

Sewing direction for satin stitch buttonholes sewn with the Sensor One-Step Buttonhole Foot.

Corded Buttonhole

Corded buttonholes are recommended when sewing buttonholes on stretch medium or stretch heavy fabric. Use gimp threads for a more stable durable and professional appearance. Use pearl cotton or a regular gimp thread. Attach the buttonhole foot C and use the finger on the back of the foot for holding the cord when sewing.

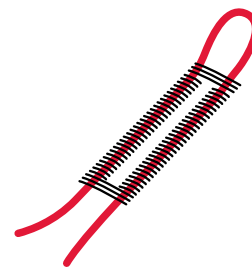

Programmable Button Sew On

Sew buttons, snaps, hooks and eyes quickly with your machine. Select sew on button in the JoyOS ADVISOR™ feature.

Note: Place the thin end of the multipurpose tool under the button when sewing on light fabrics. Use the thick end for heavier fabrics. Hold in place on the fabric with transparent tape.

Note: The recommended width of 3.0 is set for most buttons. If you sew a tiny button or a very large coat button, decrease (-) or increase (+) the stitch width until the swing of the needle sews in the holes of the button or snap.

Note: An optional button foot for sewing on buttons can be purchased at your local authorized dealer.

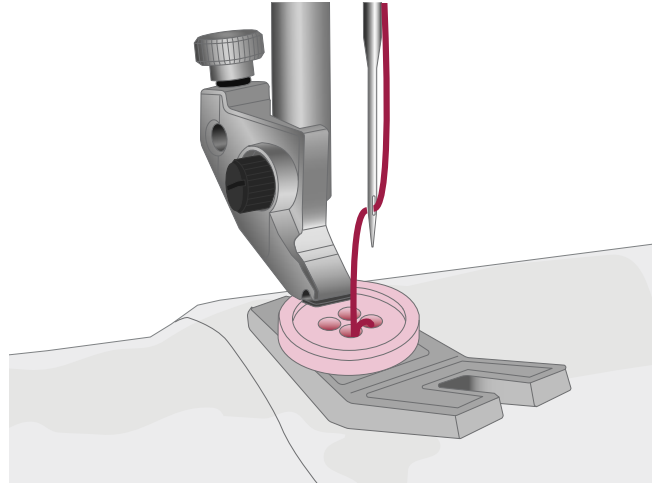

Tapering Stitches

The tapering menu will be visible when a stitch that can be tapered is selected. Touch the tapering menu to select from different angles for beginning and end tapers. The machine will sew the beginning tapered point and then continue with the selected stitch. When the desired length has been sewn, touch the reverse button. The stitch will taper to the end.

Select taper “off” to remove any tapering at the beginning or end of the stitch. If you select taper “off” on both the beginning and end, the stitch will be a regular stitch without tapering.



4-Way Stitches

The 4-way stitch allows you to sew several sturdy stitches in four different directions. You will have different 4-way stitches to choose from. This is especially helpful when patching trouser legs on a free arm. The 4-way stitches are programmed at a fixed length and stitch width.

8-Way Stitches

There are two different stitches, straight and reinforced straight stitch. Touch the arrows to select one of the pre-set sewing directions. To fine tune the direction of the stitch, use the stitch width and stitch length controls. Program these stitches alone or with decorative stitches from other menus to create unique stitches or borders.

Special Stitches For Optional Presser Feet

Includes special stitches like candlewicking and edge stitches. These techniques may require special presser feet and accessories. This is indicated by the optional presser foot icon on the screen.



Tip: Detailed information on the current selected stitch is shown in the stitch information.

Exclusive Sewing Techniques

Motif Builder Stitches

Includes two types of pictogram stitches: motifs in pairs that can be combined into a full shape and solitary motifs that can be combined into different shapes when using mirror side to side and sewn in different directions.

The projected stitch guides are used to get the perfect matching of patterns.

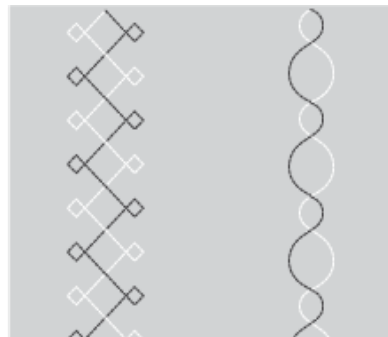

To the left: example of a solitary motif. To the right: example of motifs in pairs.

Dimensional Stitches

Dimensional stitches includes three types of stitches: appliqué, pop-up and sequin stitches. In this menu there will also be combined appliqué and pop-up stitches. Since every stitch is unique, these stitches will give different decorative effects depending on which stitch is selected and what type of fabric you have chosen.

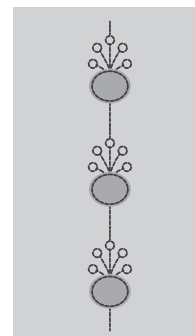

Example of appliqué stitch

Theme Stitches

Theme stitches are beautiful combined stitches, in a group of four, designed to be sewn out together in a random combination. Touch the reverse button on the front of your machine or the reverse button on the screen to change to the next stitch in the group. If you touch the reverse button twice – quickly – you will skip the next stitch in the group.

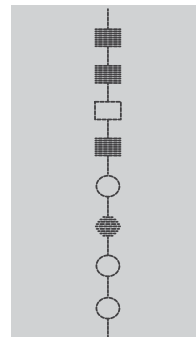

Example of theme stitch



Reverse button on the screen

Embellished Stitches

Embellished stitches are decorative stitches where you can change the appearance of the stitch after it is sewn for a special effect. These stitches can be decorated with crystals or cut for a tassel effect.

Tassel stitches are sewn with many threads on top of each other. The threads can either be left as they are sewn or cut to create a 3D effect. The long stitches should be cut at the very edge and from the top side of the fabric. To make the cutting easy, use a seam ripper.

Tip: For heavier threads, use the optional Specialty Candlewicking Foot for easier feeding.

Crystal stitches could either be used as they are or be embellished with crystals in the sewn circles.

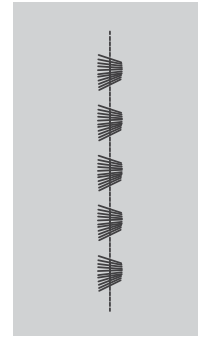

Example of tassel stitch

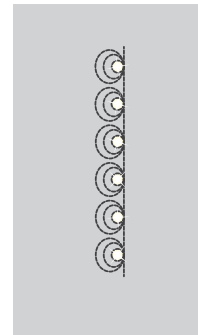

Example of crystal stitch

Floating Stitches

Floating stitches create a special effect where the connecting stitches are invisible. There are two different ways to use this technique; for the first technique, attach the optional edge joining foot, place a folded fabric centered on a piece of stabilizer and sew along the fold. The second technique is to sew two pieces of fabric together.

Once finished, unfold the fabric, giving it a good tug to reveal the decorative part of the stitch to the front.

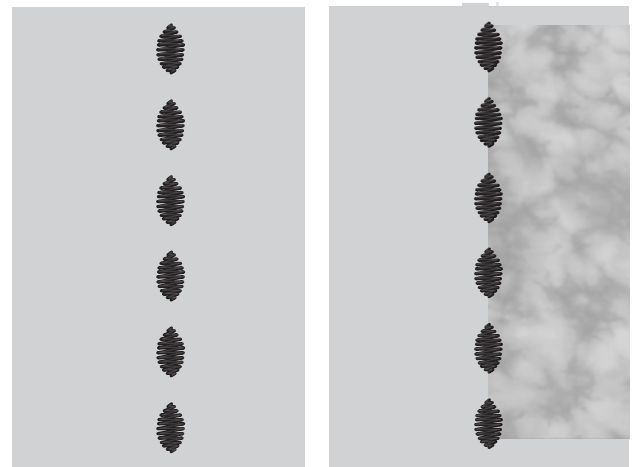

Guided Pictograms

Guided pictograms are shapes consisting of straight stitches, used together with projection to get perfect angles.

The projected stitch guides will show in which direction to sew the next part of the stitch until a full shape is created.

Pop-up Messages in Sewing

To make your sewing experience as convenient as possible, your machine will sometimes communicate with you using pop-up messages. Those messages can contain warnings, recommendations, information or prompt you to perform an action.

Below, some of the messages that can appear are listed and explained.

Bobbin Thread Low

When the bobbin thread is running low, a pop-up message appears giving you notice that you will soon need to replace the bobbin. If you want to continue sewing without replacing the bobbin, touch the foot control and do not close the pop-up.

When the bobbin is replaced with a full one, touch OK in the pop-up.

Stitch Width Safety

When stitch width safety is activated, the following pop-up message appears when you choose a stitch not suitable for stitch width safety.

Cannot Use the Automatic Needle Threader

If using a twin needle, touch OK and thread it manually. If using a regular needle, touch OK and deselect twin needle in the settings. Press the automatic needle threader button again.

Remove Sensor One-Step Buttonhole Foot

The Sensor One-Step Buttonhole Foot needs to be removed before doing any of the following:

- Sewing a stitch that is not a buttonhole.
- Sewing a buttonhole that can not be sewn with the Sensor One-Step Buttonhole Foot.
- Sewing an adjusted buttonhole saved without the Sensor One-Step Buttonhole Foot in the mySewnet cloud folder.

Check Upper Thread

The machine stops automatically if the upper thread runs out or breaks. Re-thread the upper thread, close the pop-up message and start sewing.

Attention!

If the machine stops and this pop-up appears on the screen you need to stop sewing. Wait a moment and touch OK when it is enabled. Check the needle size and condition. Check for correct threading.

Twin Needle

The following pop-up message appears when you choose a stitch not suitable for twin needle.

8 Stitch Creator™ Feature



Stitch Creator™ Feature – Overview

In Stitch Creator™, you can create completely new stitches and adjust every single stitch point. You can create a stitch all on your own or alter already built-in stitches or letters.

The width of the stitch field is 9mm and maximum stitch length is 5mm. The grid and the vertical center line will help you to create your stitch.

Stitch Creator™ feature can be used in both sewing mode and in embroidery edit.

If you want to edit a stitch created in Stitch Creator™, touch and hold on the work area and the smart toolbox will appear.

Your stitch can be saved to the mySewnet cloud folder or to a USB device. In embroidery edit the stitch is saved as a design and cannot be sewn as a stitch in sewing mode.

A stitch created in Stitch Creator™ feature can be used as part of a sequence. In sequence, locate your saved stitch. The stitch will be inserted at the cursor position in the sequence.

Note: Some stitches and fonts are not available to edit in Stitch Creator™ feature, for example buttonholes, stitches wider than 9mm and four direction stitches.

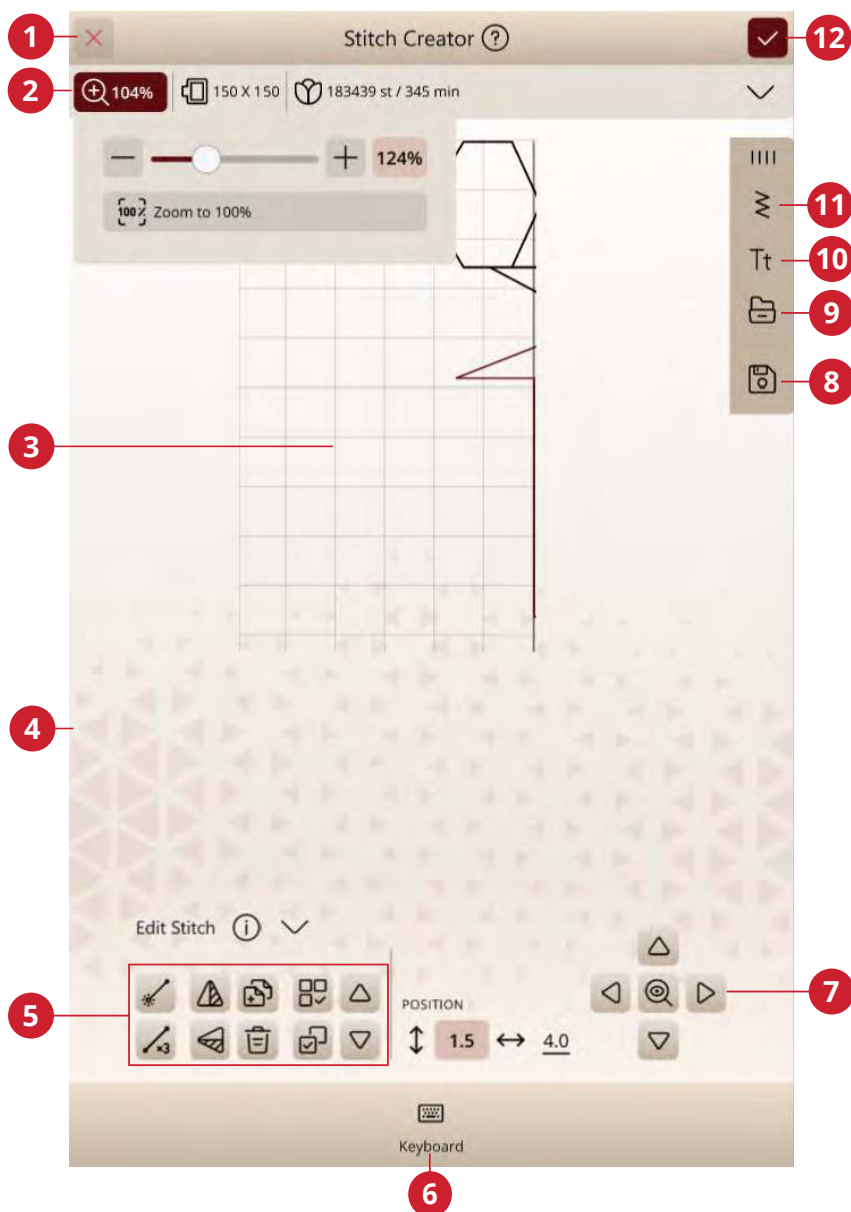

- | | | |
|-----------------|----------------|-----------------|
| 1. Cancel | 5. Edit stitch | 9. File manager |
| 2. Zoom options | 6. Keyboard | 10. Font menu |
| 3. Stitch field | 7. Control | 11. Stitch menu |
| 4. Preview | 8. Save | 12. OK |

Getting Started with Stitch Creator™

Definition of a Stitch Point

A stitch point is the point where the needle goes through the fabric. Stitches are connected by stitch points.

Each stitch point is indicated by a dot (A). A marked stitch point is indicated by a filled square (B). A selected stitch point is indicated by an outlined square (C).



Select Stitches/Stitch Points

To select a stitch point, just touch it on screen. If selecting more than one stitch point, the stitches in between will automatically be selected as well.

To mark the previous or next stitch point in your stitch, touch the select multiple icon and use the arrows. The current stitch position is shown between the arrows. The first number is the marked stitch point. The second number is the total number of stitch points.

To select all stitch points at the same time, touch the select all icon.

Select Multiple

To select the stitch points next to the marked stitch point, touch select multiple and then touch the arrows to select the next stitch point.

Use the up arrow to select stitch points before the marked stitch point and the down arrow to select the stitch points after the marked stitch point.

Note: If selecting stitch points using the up arrow, you can deselect them by touching the down arrow.



Select All

To select all stitch points at the same time, touch the select all icon. To deselect all, touch the icon again.



Preview

When making a stitch in Stitch Creator™ a preview of your created stitch will appear. This will help you see what the stitch will look like when having several repeats.



Edit Stitch in Stitch Creator™

Zoom Options

When using the zoom slider, the focus will be on the marked stitch point.

The distance between the grid lines at 100% zoom, equals 1mm on the fabric. If you zoom in on the stitch field, the distance between the grid lines will change. If zooming out, only the edge lines of the stitch field will be visible.

You can also zoom in/out by pinching and stretching or use the zoom to 100%.

Move

To move your stitch or stitch point, you can select stitch points directly on the screen using your fingers or by touching the arrows in the wheel.

The number next to the vertical position shows the actual needle position from the center line for the marked stitch point.

The number next to the horizontal position shows the actual feeding length from the previous stitch point.

Duplicate Selected Stitch Point

If you want to duplicate a stitch point, select the stitch point and use duplicate to create a copy.

If several stitch points are selected, all stitch points will be duplicated and inserted after the marked stitch point.

Touch & hold on the duplicate icon to enter the exact number of duplicates you want to insert.

Delete Selected Stitch Point

If you want to delete a single stitch point, select the stitch point and touch the delete icon. If more than one stitch point is selected, they will all be deleted when touching the delete icon.

Touch & hold on the delete icon to delete all stitch points in the stitch field.

Mirroring

The selected stitch point(s) will be mirrored horizontally and/or vertically.

Note: Only enabled if more than one stitch point is selected.

Triple Stitch

Touch the triple stitch icon and the selected stitch(es) will be tripled.

Note: Only enabled if more than one stitch point is selected.

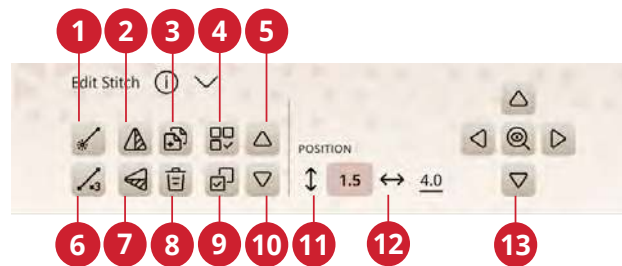

1. New stitch point
2. Mirror side to side
3. Duplicate
4. Select all
5. Previous stitch
6. Triple stitch
7. Mirror end to end
8. Delete
9. Select multiple
10. Next stitch
11. Actual feeding length
12. Actual needle position
13. Fine tuning controls



Mirror side to side/end to end



Triple Stitch

Add a Stitch or Stitch Point

You can also add an existing stitch from the stitch selection shortcut in the menu bar or the selection menu.

Touch the icon to insert one single stitch point. The two stitch points will create a new stitch.



New Stitch

Pop-up Messages in Stitch Creator™ Feature

To make your sewing experience as convenient as possible, your machine sometimes communicate with you using pop-up messages. Those messages can contain warnings, recommendations, information or prompt you to perform an action.

Below, some of the messages that can appear are listed and explained.

Not an Editable Stitch

Some stitches are not available to edit in Stitch Creator™ feature. Buttonholes, stitches wider than 9mm and four direction stitches cannot be opened in Stitch Creator™ feature.

Sequence Out of Range

Your stitch sequence can be up to approximately 500mm (20") long. If the sequence exceeds the maximum length this pop-up will let you know that stitch or stitch point you are trying to add will make the sequence too long.

9 Embroidery Edit



Embroidery Edit — Overview

In embroidery edit you can adjust, combine, save and delete designs, stitches and fonts.

You can edit your design combinations without having the embroidery unit connected to your machine. The loaded design(s) are shown in the embroidery area.

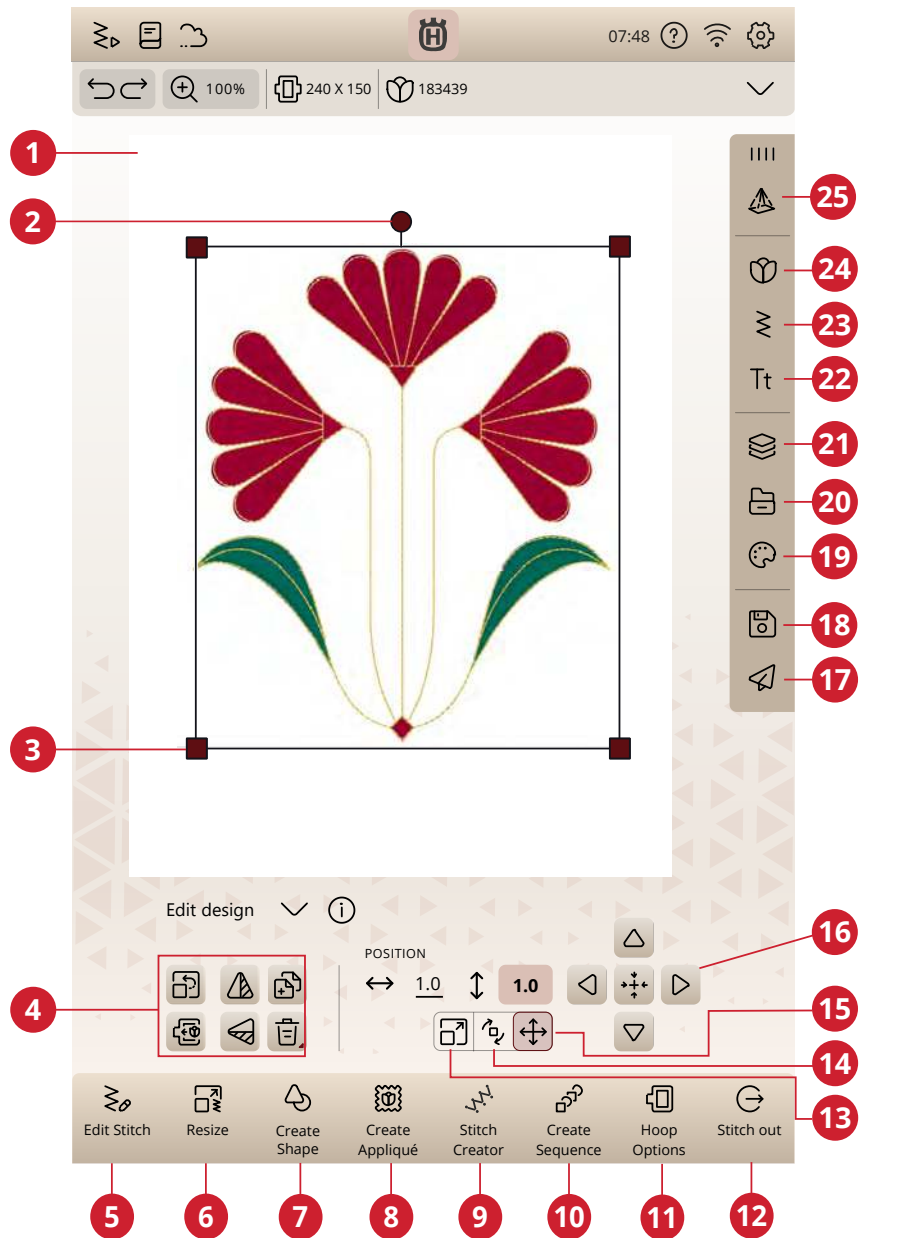

- | | | |
|----------------------------|---------------------------------|---------------------|
| 1. Embroidery area | 10. Create sequence | 19. Color edit |
| 2. Rotate handle | 11. Hoop options | 20. File manager |
| 3. Scale handles | 12. Go to embroidery stitch-out | 21. Layers |
| 4. Edit design | 13. Scale | 22. Font menu |
| 5. Edit stitch | 14. Rotate | 23. Stitch menu |
| 6. Resize | 15. Move | 24. Design menu |
| 7. Create shape | 16. Fine tuning controls | 25. Projection menu |
| 8. Create appliqué | 17. mySewnet send design | |
| 9. Stitch Creator™ feature | 18. Save | |

Load a Design

Touch the design menu and select a design. Available design categories are listed horizontally, swipe to see more categories. All available designs within the same category are listed vertically, swipe to see more designs. Touch & hold on a design to load it to embroidery edit and place it where you like. Touch once to select a design and touch again to load it to embroidery edit, it will be placed in the center of the hoop.

The entire menu window can be expanded if you touch and drag the triangle icon in the corner.

When a design is selected, you get a short description about the design.



mySewnet Library

mySewnet library is a subscription service where you can get access to thousands of embroidery designs. Visit our website to read more about this service and start your subscription.

If you have a subscription, WiFi is connected and you have logged in to your mySewnet account, the mySewnet library will be visible in your machine. Here you can scroll and select from all your mySewnet library designs.

Use the search function to find different types of designs. There are several ways to filter and sort designs. Filter designs by size by changing the maximum width and/or maximum height. Designs you've marked as favorite designs in mySewnet can also be filtered in your machine if you touch the favorite designs button.

You can also sort the designs by color block count, size (area) or stitch count. Touch the sort from button to sort from highest to lowest value. Touch the sort from button again to sort from lowest to highest value instead.

To remove all applied filters and clear your search, touch reset.

If you haven't started a subscription yet, the mySewnet library menu will still be visible in your machine, but no designs in this menu will be shown.

Load a Font

Text can be created with embroidery fonts and stitch fonts. If you select a font the embroidery text keyboard will open.

Read about Embroidery Text.



Load a Stitch

Touch load stitch to open the stitch menu and select a stitch. Available stitch categories are listed horizontally, swipe to see more categories. All available stitches within the same category are listed vertically, swipe to see more stitches.

Touch & hold on a stitch to load it to embroidery edit. The stitch menu window size can be changed by touching and dragging on the colored triangle in the lower corner. The entire menu panel can be moved around on the screen.

Simply touch & hold on the panel top to move where you want it to be placed.

Touch & hold on a stitch to load it directly to the embroidery area without the preview.



Load Saved Files

Load designs, stitches or sequences that you have saved in your mySewnet cloud folder or on a USB device from file manager.

It is possible to load previously stored patchwork, single stitch and tapering programs into embroidery edit to stitch out in the hoop.



Color Edit

To change the thread color on more than one color block at a time, touch the select multiple icon, then touch the color blocks to select the ones you want to change.

Touch the select all icon to make changes to all color blocks at one time. The select multiple icon is automatically selected.

Use the select equal icon to change all the same color blocks at one time. Touch the color block you want to change, then touch the select equal icon to select all identical color blocks in the list. The select multiple icon is automatically selected.

If two or more different color blocks are selected, select equal will select all identical color blocks of all of the selected colors.

Selected color blocks are highlighted. Color blocks that are not selected will be greyed out in the embroidery area on the screen to make it easy to see which color blocks in the design will be changed.

Touch the selected color block to deselect and show all color blocks in the embroidery area again.

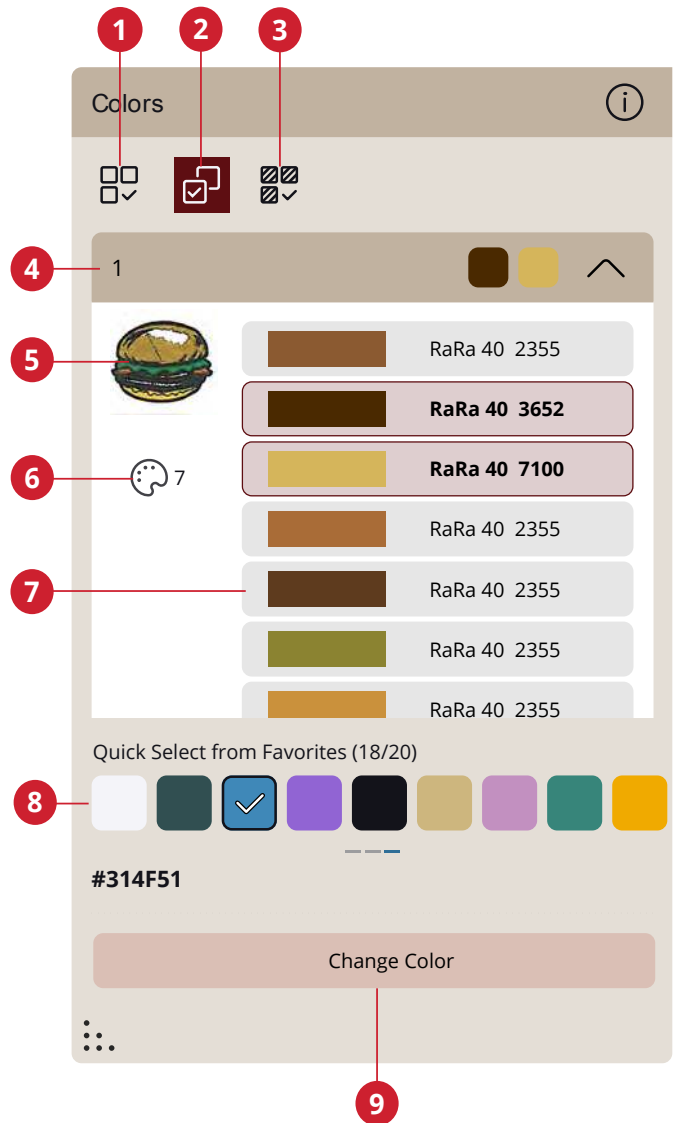

1. *Select all colors*
2. *Select multiple colors*
3. *Select same colors*
4. *Color blocks for design number 1*
5. *Design thumbnail*
6. *Number of colors in the design*
7. *Color block and color number*
8. *Quick select from favorites*
9. *Change color*

Change Color

You can edit the colors in your design. Each color block is represented in a color block list next to the design thumbnail image. Touch the color that corresponds to the color block that you want to change. You can either choose to quick select directly from your favorites or touch change color.

Use the color picker to select the color you prefer. The currently selected color is shown in the color circle.

You can also select a color by choosing from a thread color list or by entering a specific thread color number.

If you want to save a color as a favorite, touch the “+”. A selected color can also be replaced or removed by touching the respective function.

If you regret a color selection, touch cancel and you will return to embroidery edit without changing color.

When you are satisfied with your color selection, touch apply to confirm.

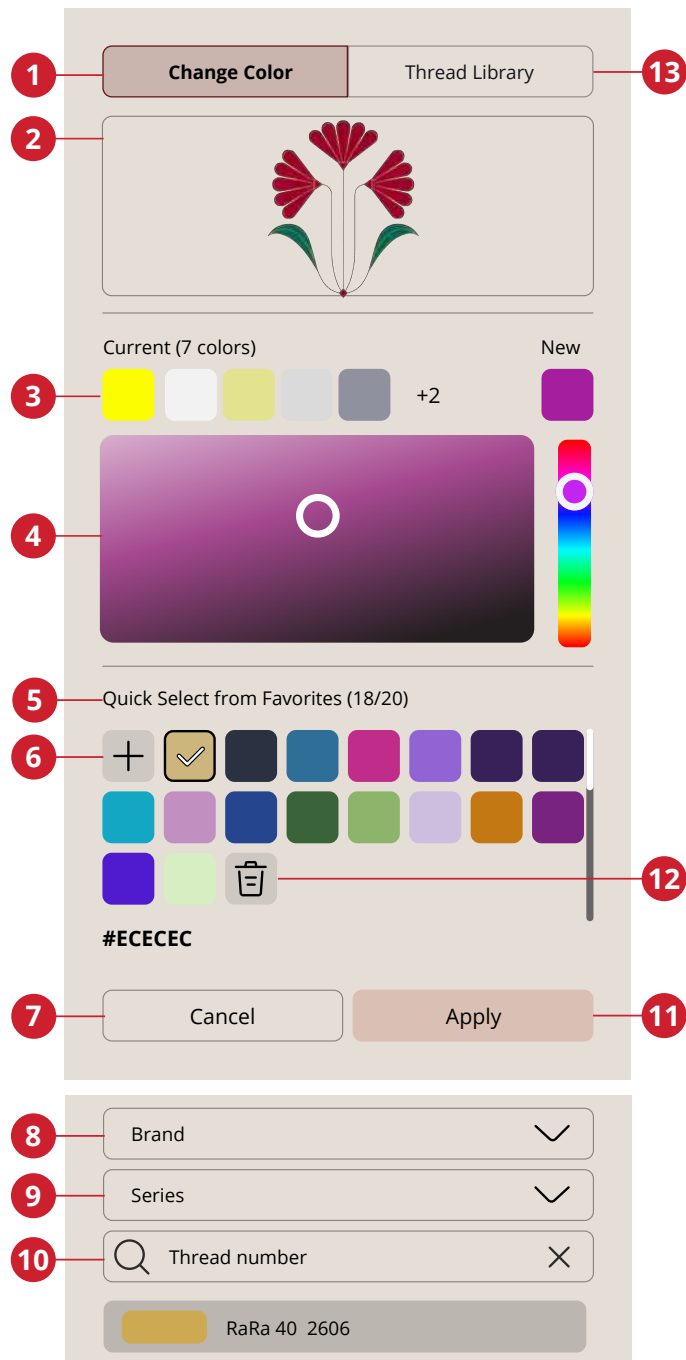

- | | | |
|-------------------------|-------------------------------|---------------------------|
| 1. <i>Change color</i> | 6. <i>Add new color</i> | 10. <i>Thread number</i> |
| 2. <i>Preview</i> | 7. <i>Cancel</i> | 11. <i>Apply</i> |
| 3. <i>Current color</i> | 8. <i>Thread brand</i> | 12. <i>Delete</i> |
| 4. <i>Color picker</i> | 9. <i>Thread model/series</i> | 13. <i>Thread library</i> |
| 5. <i>Quick select</i> | | |

Layers

You can arrange the stitch-out order of loaded designs.

To select one design, simply touch the design on the screen, or in the layers window. The selected design will be surrounded by a selection frame in the embroidery area and indicated with a different background color in the list.



Select Designs/Change Stitch-Out Order

The designs in layers window are numbered.

By default, the designs will be stitched out in the order they are loaded to the embroidery area.

To change stitch-out order, touch & hold on the layer and then drag and drop it at another place in the list.



Select All

If you want to select all designs, simply touch the select all icon. All designs on your screen will be surrounded by design selection frames. You can now make changes to all of the selected designs. If you want to combine all the designs into one design, touch the group/ungroup icon.

When you touch the select all icon it activates the select multiple icon so you can mark/unmark any design.



Select All

Select Multiple

Select multiple allows you to select two or more of the designs on your screen at the same time. Touch the select multiple icon and then touch the designs on the screen you want to select. Alternatively select the thumbnail pictures in the layers window. A design selection frame will surround the selected designs; both the thumbnail pictures in the layers window and the designs in the embroidery area. To deselect, touch the designs again in the embroidery area or the thumbnails and the design selection frame will disappear.



Select Multiple

Group/Ungroup

If you have selected two or more designs and want to combine them to be adjusted as one design, touch the group icon. A design selection frame will surround each design that is selected and, when grouped, the design selection frame will surround all of the designs in the group. Touch the ungroup icon and they will once again become individual designs.



Group/Ungroup

Edit Functions

You can move, rotate, scale and pan directly on the multi-touch screen using your fingers.

Touch the selected design with your finger to position it anywhere in the embroidery area. Use the fine tuning controls to fine tune.

The fine tuning controls varies in appearance depending on which function it is used for.

Move

Touch and move a selected design with your finger to position it anywhere in the embroidery area.

You can also touch the move icon and use the arrows to adjust the position of the selected design(s). The numbers above the arrows show the horizontal and vertical distance from the center of the hoop for the selected design(s).

Touch the move to center icon to position the selected design(s) in the center of the hoop.

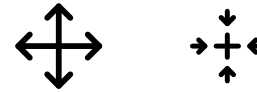

Move/ move to center

Rotate

Rotate the selected design(s) by touching the rotate handle located in the center of the top of the design selection frame and move your finger on the screen.

You can also touch the rotate icon and use the arrows to adjust the rotation of the selected design(s). Each touch on the 90 degrees icon rotates the selected design(s) 90 degrees clockwise. The number shows, in degrees, the current rotation angle.



Rotate

Scale

With the scale function, you can increase or decrease the size of the selected design(s) +/- 20% without changing the number of stitches.

Scale the selected design(s) by touching one of the scale handles in the corners of the design selection frame and move your finger on the screen. When scaling a design the original size icon will be enabled. Touch the icon and the design will return to the original size.

You can also touch the scale icon and use the arrows to adjust the size of the selected design(s). The numbers shows current width and height.

By default the proportions are locked. This is indicated with a closed padlock in the center of the fine tuning controls. Touch the padlock in the center of the fine tuning controls to unlock and activate individual scaling of width and height.

Note: To increase or decrease a design more than 20%, use the resize function.



Scale



Original size



Lock/ unlock

Duplicate/Multi Duplicate

Select duplicate to make a copy of your selected design(s).

Touch & hold on the duplicate icon to open a keypad and enter desired number of copies you want to add.



Delete/Delete All

Touch the delete icon, and the selected design(s) will be deleted from the embroidery area. If more than one design is selected, a pop-up message will appear. Touch OK to confirm to delete selected designs.



If you touch & hold on the delete icon a pop-up will appear to ask if you want to delete all loaded designs from the embroidery area. Touch OK in the pop-up message to confirm.

Mirroring

To mirror a design sideways, select mirror side to side. To mirror a design lengthwise, select mirror end to end.



Mirror side to side/mirror end to end

Move into Hoop

A red frame will surround the embroidery area if a design is placed outside the hoop area. Select move into hoop to move any design that is outside the hoop area into the hoop area. The design will be placed at the outermost edge of the hoop.



Undo/Redo

Touch the arrow pointing left to undo your latest design adjustment. Touch repeatedly to step back through your adjustments.

Touch the arrow pointing right to redo your latest design adjustment. Touch repeatedly to step forward through your adjustments. Redo is only activated when undo has been touched.



Undo/redo

Note: Not all adjustments can be undone. They will be greyed out if undo/redo are not possible.

Pan

To pan the embroidery area, touch anywhere outside the loaded design(s) and move your finger.

To return to centered view of the hoop, touch zoom to hoop.

Zoom Options

Zoom to all will show all the design(s) in the embroidery combination. Zoom to hoop will adjust the embroidery area to fit the selected hoop.

Use the zoom slider and move to the right to zoom in and to the left to zoom out. The percentage of magnification will be shown above the slider.

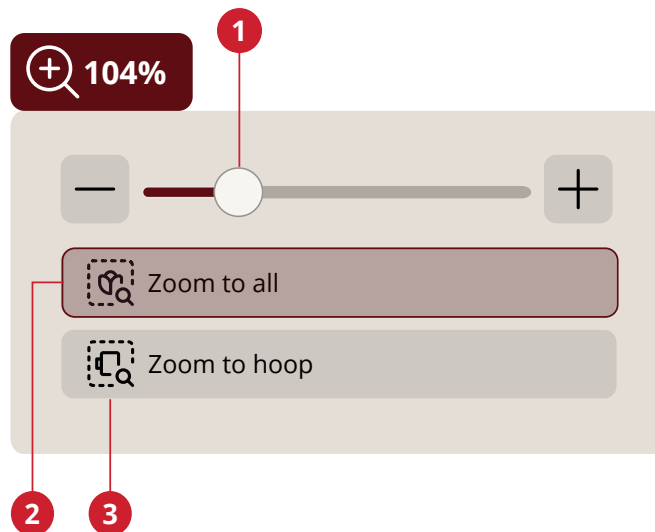

1. Zoom slider
2. Zoom to all
3. Zoom to hoop

Hoop Options

In hoop options you can change the embroidery area background, background color, hoop size and activate/deactivate a grid and alignment.

Select Hoop

A list is shown with hoop choices, including hoops that are available to purchase from your authorized HUSQVARNA® VIKING® retailer.

Touch one of the hoops in the hoop size list to select the correct hoop size.

Note: You can select a specific default hoop size in settings. The machine will then always select this hoop when loading a design, independent of the design size.

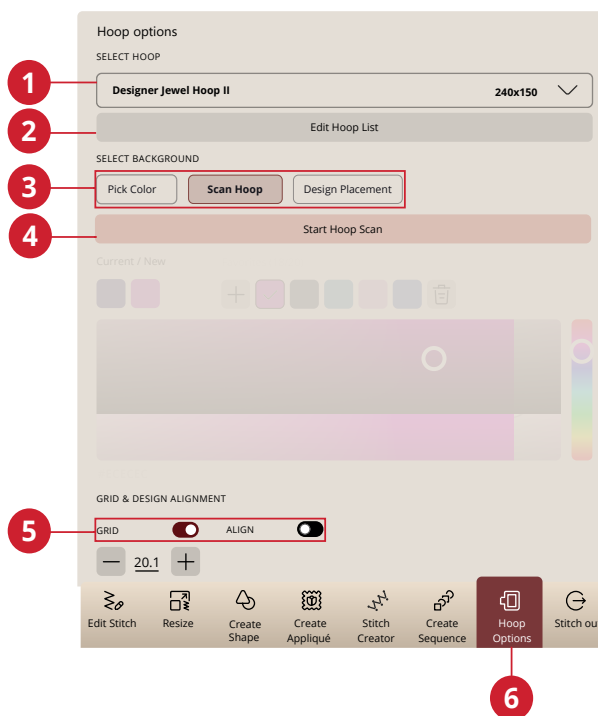

1. Select hoop
2. Edit hoop list
3. Select background
4. Start hoop scan
5. Grid options
6. Hoop options

Scan Hoop

You can use your fabric as a background in embroidery edit.

Make sure the embroidery unit is attached and then touch scan hoop.

The embroidery arm will need to calibrate. When the calibration is complete, attach the hoop you want to use.

The scanning process will start when the hoop is attached and you have given approval for the next step. If you want to cancel the process you can press cancel in the pop-up window.

When the process is done, you will see the scanned background in the embroidery area.

Background

Customize your the embroidery area by choosing from different type of backgrounds. You can use your scanned hoop, a color similar to your fabric, or a background from the mySewnet app.

Grid Options

Activate/deactivate grid by touching the check box.

Use the grid as a guide when you combine or place designs.

You can set the distance between the grid lines by entering a number in the keypad.

Note: Touch & hold on the embroidery area to open the smart toolbox and select grid on/off.

Alignment

If activated, guides will appear when moving your design around the screen. This will help you to easier line-up two designs to one another.

Background Color

Choose between different background colors for the embroidery area that matches the color of the fabric you will use.

mySewnet Send Design

Send selected embroidery designs directly to other mySewnet enabled devices. Choose any of the available devices by touching it. The pop-up closes and the selected design(s) are sent.

Note: You can only send designs to devices connected to the same mySewnet account.



Edit Stitch

Touch edit stitch to open the control window for adjusting selected stitch.

Note: The default setting is always shown in white numbers.

Read about adjusting your stitch in Edit Stitch.



Resize

Resize can reduce or increase an embroidery design. The machine recalculates the number of stitches in the design so the original stitch density remains.

Note: To reduce or increase the design less than 20%, use the scale function. The scale function does not change the stitch count.



Resize

Resize Adjustments

To change the size of the design, touch one of the resize handles in the corners of the design selection frame and move your finger on the screen. When resizing, the height and width of the design are always adjusted proportionally. You can also use the direction arrows to reduce or increase the design. The numbers show the current width and height in millimeters/inches.

When you resize a design the original size icon will be enabled.

Touch to return to the original size (length and width).

Adjust the placement of the design in the hoop using move and/or rotate.

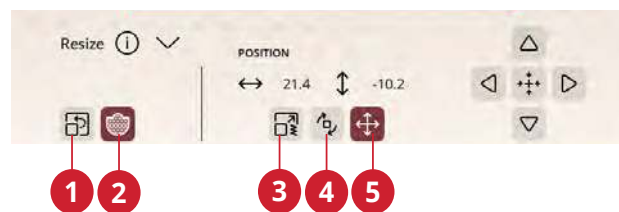

1. Original size
2. Retain filltype
3. Resize
4. Rotate
5. Move

Retain Fill Type

Some fill areas in an embroidery design are made in a specific fill type to achieve the best results. When enlarging or reducing a design, the stitches in the fill area will be affected. The retain fill type function is selected by default, this will keep the fill types as they were originally created.

Retain fill type gives the best result in most cases. If your design becomes distorted, try resizing without retaining the fill type. Reload the original design, deselect retain fill type and resize your design again.



Retain Fill Type

Embroider Your Resized Design

When you are satisfied with the design size and position, touch OK. The resize window will close and your resized design is loaded to the embroidery edit window.

Touch cancel to return to embroidery edit without resizing.

Note: Stitches and stitch programs cannot be resized.

Important Resize Information

Since designs are digitized for a specific design size, it is important to consider the following information about resize. Always embroider a test sample of your resized design before embroidering on a project.

- Resize is always proportional. If you reduce a design 30%, it will be 30% smaller in both length and width. If the design is very detailed, some of it may be lost or distorted, and/or it can become very dense. Some designs, especially those with lots of detail, should not be reduced more than 25%.
- Designs can be resized larger than the selected hoop. After resizing, make sure the design fits or select a larger hoop for the machine to be able to embroider it.
- If you enlarge a design too much, you may see stitch irregularities. Touch the original size icon to return to original size and resize to a smaller percentage for a better result. Please use the embroidery software to resize very large and complex designs. Go to www.mysewnet.com to learn more.
- It does not matter in which order you select functions to adjust the size, position and rotation. When you touch OK, your machine always resizes first and then adds the other adjustments.
- It is recommended that you scale instead of resize to change a design less than 20%. Scale is also recommended for designs digitized with single or triple stitches, such as cross stitch embroideries. In this case, you do not want to add stitches to the design, you only want to make the design larger or smaller by making each original stitch larger or smaller.
- Always start with the original design when resizing. This is to ensure the best possible stitch quality. If a resized design is saved, and then resized again, it can cause stitch irregularities.

Embroidery Text

To create a text, start by selecting an embroidery font. Use the keyboard to write your text and touch OK when finished to close the keyboard. If you want to adjust an existing text in embroidery edit, select the text design, touch & hold on the embroidery text to open the smart toolbox and select edit embroidery text.

Create a Text

Use the keyboard and touch the letters you want to add to the text. The text is shown in the embroidery area and in the text area above the keyboard.

You can change the font and the size of the entire text by touching another embroidery font in the font menu. The text that is written will change to the new font and/or font size in the embroidery area.

Add a Letter

Use the cursor arrows to move the cursor to where you want to add a letter into a text. Touch the letter and it will be inserted at the cursor position. You can also touch with your finger in the text area to move the cursor.

Delete a Letter

To delete a letter, place the cursor after the letter to be deleted. Touch the delete icon. If you want to delete all text that is written, touch & hold the delete icon.

You can also touch & hold in the embroidery area to open the smart toolbox and select delete or delete all.

Text Shaping

You can shape your written text with different shaping functions.

Select Text Shape

Touch the select text shape icon to open and select a shape line. Touch a shape line and your text will follow the shape line on the screen. The arrow indicates the direction your text will follow when adding letters to the shape line.

To change the size of the shape, touch one of the scale handles in the corners of the design selection frame and drag your finger on the screen.

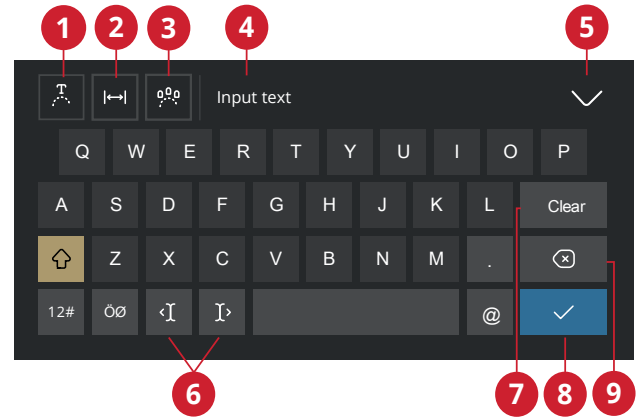

1. *Select text shape*
2. *Select text spacing*
3. *Select letter angle*
4. *Text area*
5. *Close the keyboard*
6. *Cursor arrows*
7. *Clear*
8. *Done*
9. *Delete*

Select Spacing

Touch the select spacing icon to open options for spacing your text along the shape line: evenly spaced, left justified, centered or right justified. Evenly spaced will place the text evenly along the shape line with an equal distance between all letters. If you choose left justified the text will begin loading to the left. Centered will center the text on the shape line. If you choose right justified, the text will begin loading to the right. The distance between each letter can be increased or decreased with the spacing slider, except for when evenly spaced is selected.

Fixed Letter Angle

Decide how to align the letters on the baseline. Select to have the objects placed parallel to the baseline or to keep the current angle. The setting affects all objects on the shape.

Create Shape

Creating shapes is a unique way to take your creativity to another level. Use your beautiful stitch sequences or embroidery designs to form one of several shapes.

The stitches/designs will be placed along the baseline in the order that they are loaded.

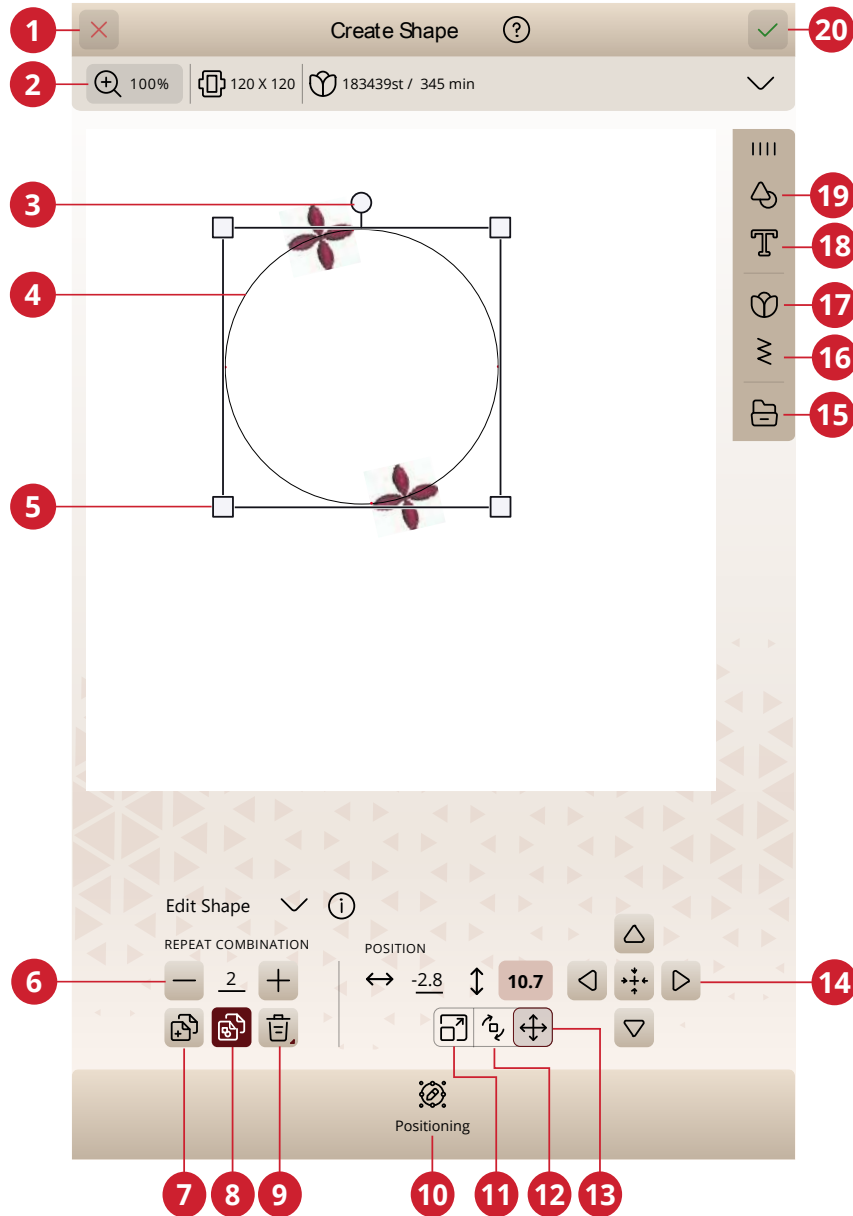

- | | | |
|--------------------------|--------------------------|-------------------|
| 1. Cancel | 8. Repeat combination | 15. File manager |
| 2. Zoom options | 9. Delete | 16. Stitch menu |
| 3. Rotate handle | 10. Positioning | 17. Letter shapes |
| 4. Shape line | 11. Scale | 18. Font menu |
| 5. Scale handles | 12. Rotate | 19. Shape menu |
| 6. Set number of designs | 13. Move | 20. OK |
| 7. Duplicate last design | 14. Fine tuning controls | |

Repeat Combination/Duplicate Last Design

Add more designs onto your shape in two different ways. When using repeat combination, the designs will be added to the shape in the same order as the ones already loaded. When using the duplicate last design, only the last added design in the shape will be added. Touch in the number area to open a keypad to set the number of designs.

Note: Duplicate, delete or set number of designs/stitches are not available when shaping an embroidery text. Read about how to adjust your text while shaping in the embroidery text chapter.

Set Number of Designs/Stitches

If you want to enter the total number of designs/stitches you want in your shape, touch the number to open a keypad. Enter the desired number of designs/stitches in the keypad and touch OK.

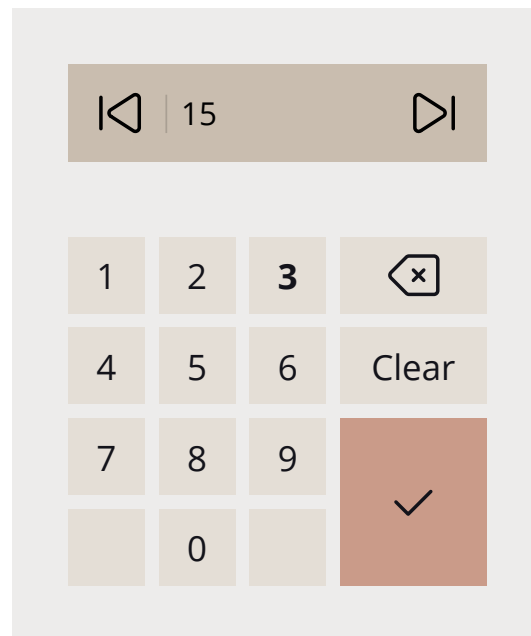

Create Appliqué

You can add an appliqué to your quilt or garment easily using this feature. In your DESIGNER EPIC™ 3 machine there are many different autofill stitches to choose from when creating the appliqué. You can also choose decorative stitches or mini designs to cover the raw edges of the appliqué.

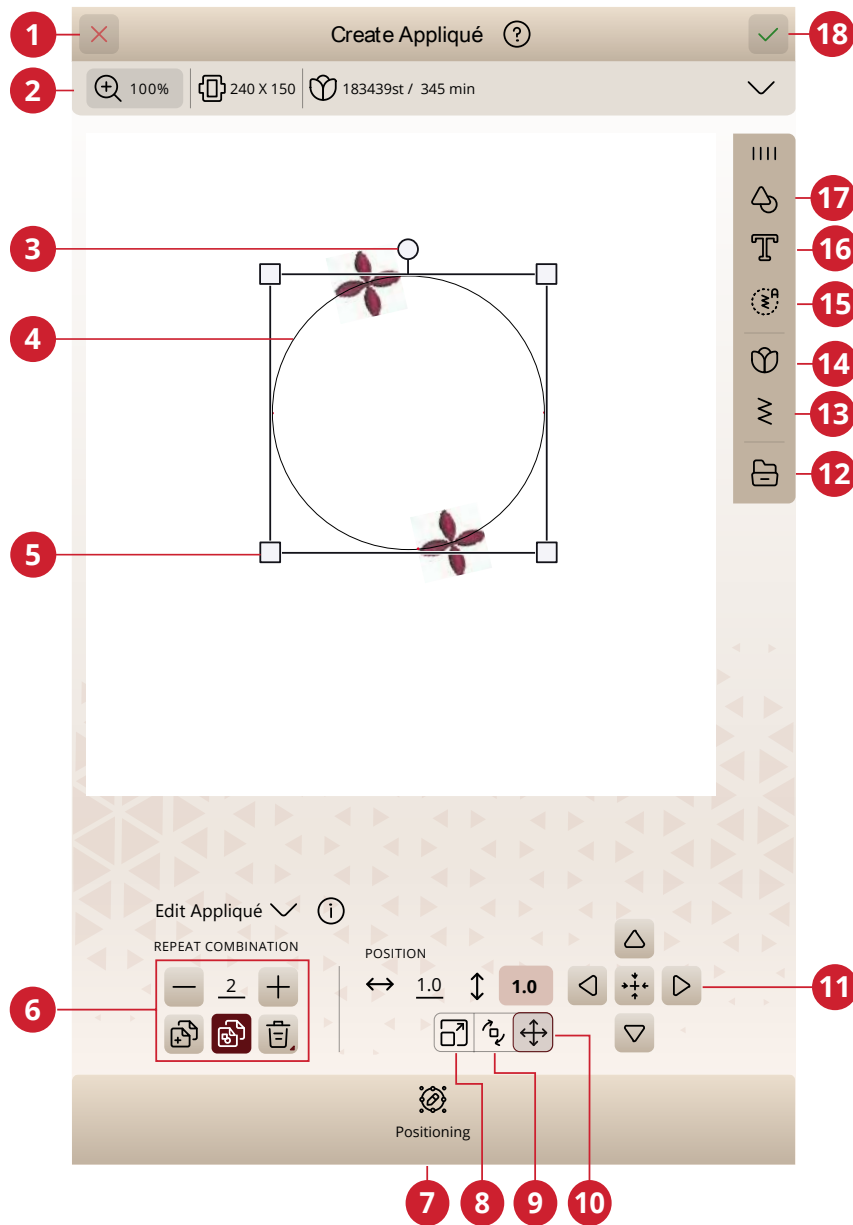

- 1. Cancel
- 2. Zoom options
- 3. Rotate handle
- 4. Shape line
- 5. Scale handles
- 6. Edit design

- 7. Positioning
- 8. Scale
- 9. Rotate
- 10. Move
- 11. Fine tuning controls
- 12. File manager

- 13. Stitch menu
- 14. Design menu
- 15. Autofill stitch
- 16. Letter shapes
- 17. Shape menu
- 18. OK

Stitch Out an Appliqué

The first color block will sew a straight stitch outline on the base fabric to show where the appliqué will be sewn.

Place your appliqué fabric over the outline stitch on the base fabric. Make sure that your appliqué fabric covers the outline.

The second color block will sew another straight stitch to secure the appliqué fabric to the base fabric.

Trim excess appliqué fabric as close to the stitching line as possible.

The stitches in color block three will cover the raw edges of your appliqué.

Load Autofill Stitch

If you select an autofill stitch it will fill the shape with enough stitches to fill the entire shape. If selecting a decorative stitch or a mini design you will need to set the number of the stitches/designs you want to add.

Note: When creating an applique using a decorative stitch/mini design you can edit each stitch/design individually.



Positioning in Create Shape/Create Appliqué

Touch the positioning icon to make adjustments to your shape.



Select Spacing

You have several options for spacing your designs along the shape line: evenly space, left justified, centered or right justified. Evenly spaced is selected by default and will place the designs evenly along the shape line with an equal distance between all designs. If you choose left justified the designs will begin loading from the left. Centered will center the designs on the shape line. If you choose right justified, the designs will begin loading from the right. The distance between each design can be increased or decreased with the spacing slider, except for when evenly spaced is selected.



Select Line Positioning

You can place your designs horizontally, relative to the shape line: above, centered or below.



Select Side Positioning

There are several options for how the designs will be rotated on the shape line: no rotation, rotate 90 degrees clockwise, rotate 180 degrees or rotate 90 degrees counter-clockwise.



Fixed Design Angle

You can select design angle to align all the designs in a fixed, vertical rotation on the shape line. Deselect to keep the current angle along the shape line.

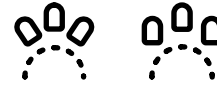

Control Points

A control point is a point affecting the selected shape. Each shape is built by several control points. Together they define what the shape will look like.

A selected control point is marked with a filled square. An unselected control point is marked with an outlined square. All control points are visible when you are editing the points. By adjusting the control points, the selected shape can be changed with unlimited possibilities.

Note: The possibility to change the design using control points is only available for the basic shapes.

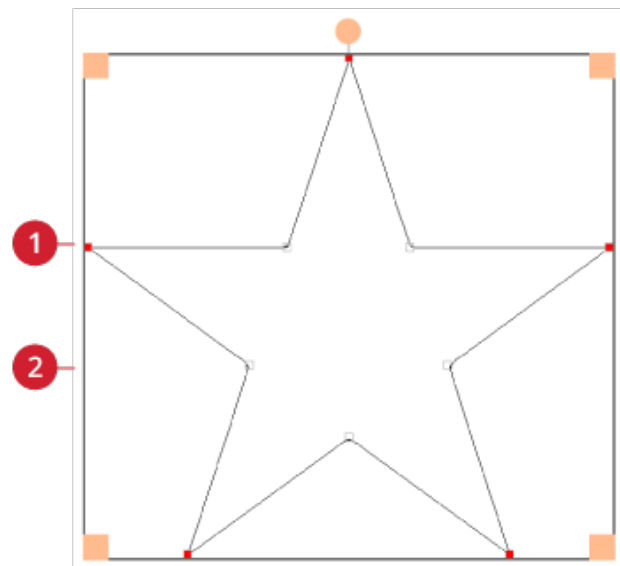

1. Selected control point marked with a filled square

2. Unselected control point marked with an outlined square

For each shape, there are pre-defined sets of control points. Select all or some of the control points.

When you have selected a set of control points, you can make adjustments to the shape: move, rotate and scale. The adjustments made will only affect the selected control points.

To increase or decrease the smooth of the selected control points use the smooth control. The higher number, the closer the baseline will be to the selected control points.



Save Design

To save your file, touch save. You can choose to save your file to the mySewnet Cloud folder or to a USB device. Previously saved designs, stitches, sequences and/or fonts are shown.

Read about organizing your saved stitches in File Manager.

When saving current state, all your adjustments are stored and you can continue later by touching “continue from saved state” at the home screen.

Note: You can only have one current state saved at a time.



Save

Pop-up Messages in Embroidery Edit

To make your experience as convenient as possible, your machine sometimes communicate with you using pop-up messages. Those messages can contain warnings, recommendations, information or prompt you to perform an action.

Below, some of the messages that can appear are listed and explained.

Embroidery Combination is too Complex

This pop-up message appears e.g. for one of the following reasons:

- The design combination contains too many color blocks.
- There are too many designs in the combination.
- One or more designs have been grouped and re-grouped too many times.
- The design combination you are trying to make contains too many stitches. Your design combination can have a maximum of approximately 500,000 stitches.

Exceeded Maximum Number of Stitches

The design combination you are trying to make contains too many stitches. Your design combination can have a maximum of approximately 500,000 stitches.

10 Embroidery Stitch-Out



Embroidery Stitch-Out – Overview

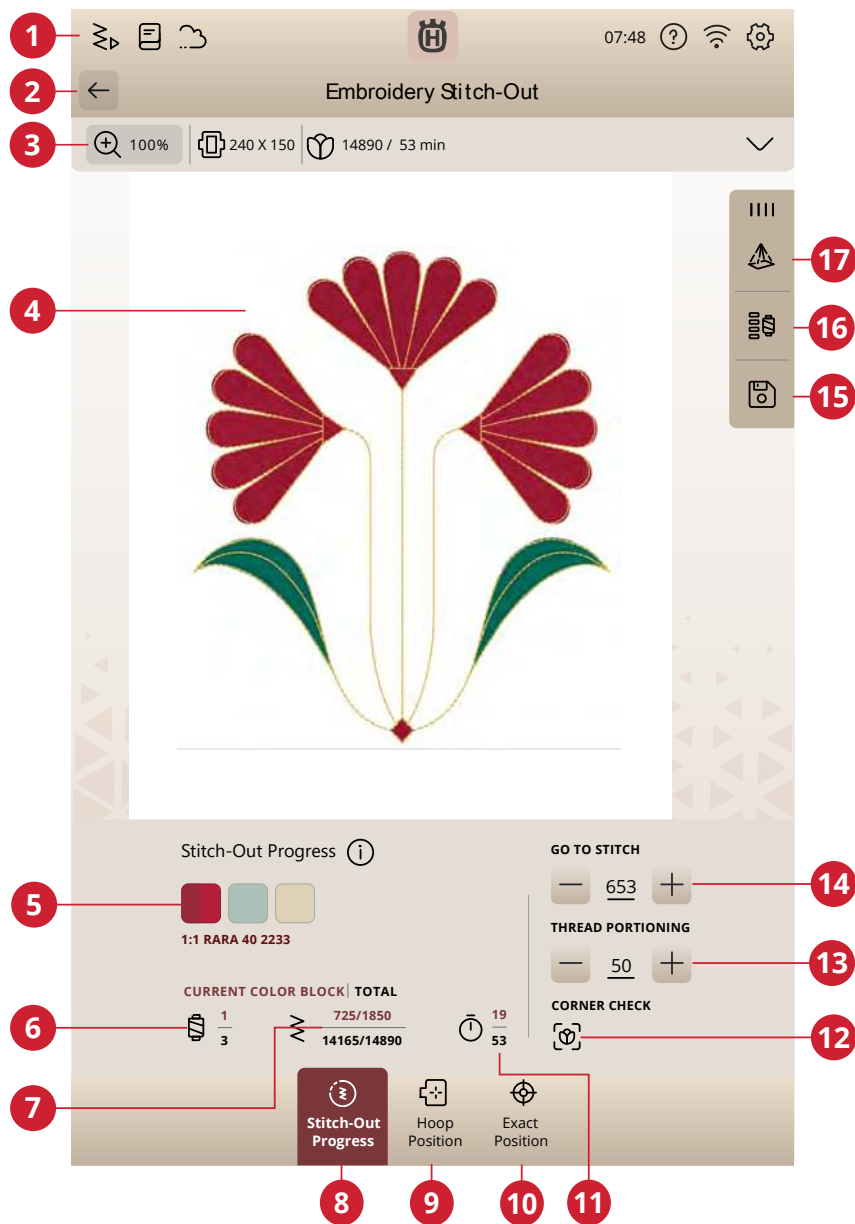

- | | | |
|--|--|---|
| <ol style="list-style-type: none"> 1. Go to sewing mode 2. Go back to embroidery edit 3. Zoom options 4. Embroidery area 5. Stitch out progress 6. Current color block number/total number of color blocks | <ol style="list-style-type: none"> 7. Current stitch/total stitch count for: current color block/embroidery combination 8. Stitch-out progress 9. Hoop position 10. Exact position 11. Remaining embroidery time by color block/designs | <ol style="list-style-type: none"> 12. Corner check 13. Thread portioning/thread tension 14. Step stitch-by-stitch/go to stitch 15. Save 16. Color block options 17. Projection |
|--|--|---|

Review the Embroidery Stitch-Out Settings

Before starting to embroider, review the embroidery stitch-out settings to check that everything is set as you desire. You can select to skip this screen in future embroideries.

Attached Needle Plate

The straight stitch plate is generally recommended for best results in embroidery. Your DESIGNER EPIC™ 3 machine senses which needle plate is attached. If the needle plate shown is not the one you wish to use, attach your preferred needle plate.

Selected Hoop

The currently selected hoop in embroidery edit is shown. If you want to change the hoop, return to Embroidery Edit and change the hoop in Hoop Options.

Selected Foot Type

Select which embroidery foot type you will use for the embroidery. The Sensor Q-Foot and *deLuxe*™ Stitch System are recommended for best embroidery results.

Basting Options

Select basting to add a basting stitch that will secure your fabric to your stabilizer. You can choose either baste around design or baste around hoop or both. Basting can also be activated in the color block list. Read about basting options.

Thread Cut Options

Any settings for the thread cut options made in embroidery settings will be shown here and you can change the thread cut options here as well.

Turn Off Stitch-Out Settings

Check the “Don’t show this information again” box to go directly to embroidery stitch-out, without reviewing the embroidery settings.

This function can be reactivated in machine settings.

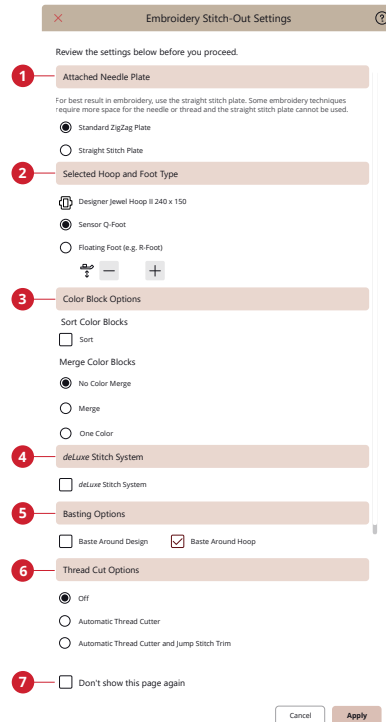

1. *Attached needle plate*
2. *Selected hoop & foot type*
3. *Color options*
4. *deLuxe™ Stitch System*
5. *Basting options*
6. *Thread cut options*
7. *Don't show this page again*

deLuxe™ Stitch System

When the *deLuxe™* Stitch System feature is selected, your machine will automatically choose the best way to control the upper thread, by thread portioning or thread tension, based on your selected stitch and settings. Thread portioning automatically and continuously measures the fabric thickness to meter the correct amount of thread for the selected stitch. When using thread tension, the tension discs will keep the correct amount of tension on the upper thread.

Thread portioning is the recommended setting for embroidery except when using certain optional accessories or special techniques which may require the use of thread tension for best results.

Color Options

Preset your embroidery with any of the three color options: color block sort, color block merge or one color. You can also set these options in the color block list. Read more about color block sort, color block merge or one color.

Note: You can set both color block sort and color block merge if desired.

Turnable Hoop Options – Side Sort

This option will only be visible if the 460x450 mm hoop is chosen in hoop options in embroidery edit. If you want to embroider all designs on one side of the hoop, before you turn the hoop, select the side sort option.

Color Block List

All colors in the loaded design(s) are shown in the order they will be embroidered. Each listed color shows the design number and color block order. Also shown are the thread manufacturer, thread weight and thread color number. The size of each color block gives an indication of how many stitches the color block contains.

Swipe in the color block list to see all of the color blocks. To go to another color block, touch it in the color block list.

Basting Options

Basting enables you to secure your fabric to a hooped stabilizer. It is especially useful when the fabric that is going to be embroidered cannot be hooped. Basting provides support for stretchy fabrics.

The basting options are set in the stitch-out settings window before entering embroidery stitch-out. You can also select basting in the color block list.

Select baste around design to add a basting stitch around the design, outlining the area where the design will be placed on the fabric.

Select baste around the hoop to add a basting stitch around the inside edge of the hoop.

You can select both basting options to add additional support for certain fabrics and techniques.

Note: When activated only the basting color blocks will be shown in the color block list. When basting is complete the color block list will once again show the color blocks of your design.

Ghost Mode

Touch ghost mode and only the color block that is currently stitching will be visible in the embroidery area. All other color blocks will be greyed out.

Ghost mode can be useful when your design contains color blocks in different shades of the same color, especially if they are close to or overlapping each other.

Color Block Sort

Color block sort intelligently sorts all color blocks so that the blocks with the same color will follow each other in the color block list.

Note: Color block sort has to be selected before you start to embroider. Once you have started to embroider the color block sort option will be disabled.

Color Block Merge

Select color block merge to eliminate the stops between identical color blocks.

Note: The appearance of the color block list will remain the same.

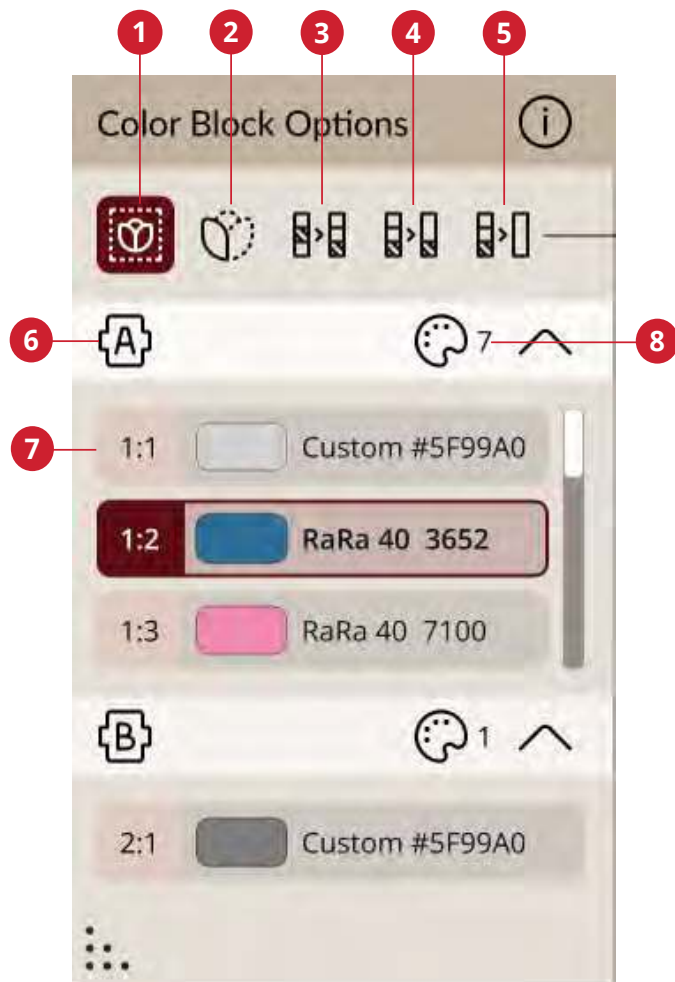

- | | |
|----------------------|---------------------------|
| 1. Basting options | 5. One color |
| 2. Ghost mode | 6. Turnable hoop |
| 3. Color block sort | 7. Color block list |
| 4. Color block merge | 8. Number of color blocks |

One Color

Select to activate one color embroidery. All designs are shown in a grey color and the machine will not stop for color block changes. To deactivate one color embroidery, deselect one color option in the stitch-out settings.

Note: If the automatic thread cutter and automatic jump stitch trim function is selected in settings, the jump stitches will still be trimmed between the color blocks.

Stitch-Out Progress

Here you will find information about the stitch-out progress, for example remaining embroidery time and current color block.

When embroidering, a cursor indicates current needle position on the screen.

You can use the stitch-by-stitch control to go to a particular stitch within the color block.

Remaining Embroidery Time

An estimation of the remaining embroidery time is shown, both for each color block and the whole design. If one color is activated, the estimated remaining embroidery time for the whole embroidery combination is shown.

Number of Stitches in Embroidery Combination

The current stitch position in embroidery combination is shown as well as the total number of stitches in the design or combination.

Step Stitch-by-Stitch / Go to Stitch

Touch – to step backwards and + to step forward stitch-by-stitch. Move backwards a few stitches, after the upper thread breaks or runs out, to ensure that the thread will be secured.

Touch & hold to move through the stitches more rapidly.

The cursor on the screen will follow the stitches in the embroidery area.

To go to a particular stitch within the color block, touch the step stitch-by-stitch icon. A keypad will open, where you can enter the stitch number. If the number entered is too large, the machine will move to the last stitch in the current color block.

Corner Check

Use corner check to trace the four corners of the design. This will make it easier to see the final placement of the design on your fabric.

Each touch will move the hoop to the four different positions and then go back to the current stitch position.

deLuxe™ Stitch System

The control visible in embroidery stitch-out will change depending on whether the *deLuxe™* Stitch System is active or not in the embroidery settings. Use the controls to adjust the balance between upper thread and bobbin thread, e.g. when embroidering with specialty thread. Read more about the *deLuxe™* Stitch System in embroidery settings.

Zoom Options

Zoom options are available on the secondary top bar. Zoom to all will show all the design(s) in the embroidery combination. Zoom to hoop will zoom to show the whole hoop on the screen.

Hoop Position

Use the hoop position options to move the embroidery hoop to different positions.

Current Stitch Position

When you want to return to the current stitch position and continue embroidering after you have changed the hoop position, touch the current stitch position. You can also press the start/stop button, on the front of the machine, once to return to the current stitch position and start the embroidery.

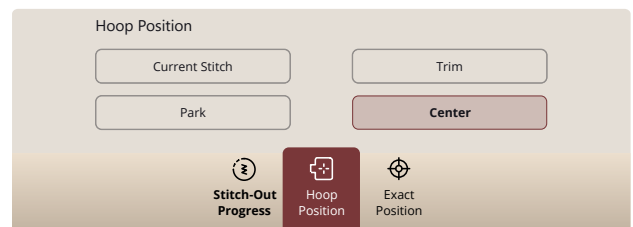

Park Position

When you have finished your embroidery, remove the hoop and select park position. The embroidery arm will be placed in a position that will allow easy storage. Use the park position when you need to have a free sewing space with the embroidery arm out of the way.

Trim Position

Trim position will move the hoop towards you, making it easier to trim threads and fabric for specialty techniques.

Center Position

When you need to remove the hoop, e.g. when changing a bobbin, touch the center position. This will also show the center position of the hoop.

Exact Position

Use exact position to place a design on an exact location on your fabric without re-hooping.

It can also be useful when you want to embroider a design to exactly match a specific spot on your project or next to a previously embroidered design.

Tip: Use the projection as a help when using exact position. By activating the projector, you can see how the design will be stitched out on the fabric.

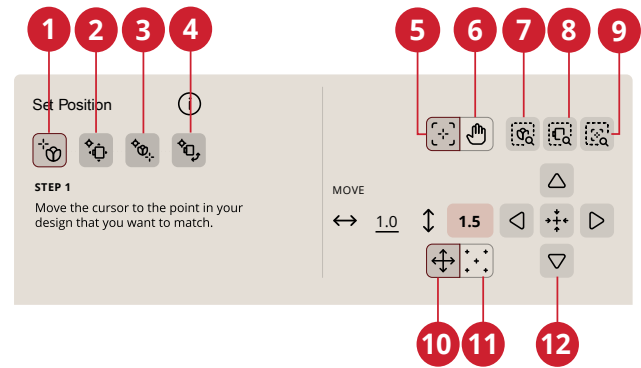

1. Select a locking point on screen
2. Set matching point on screen
3. Rotate design on fabric
4. Move locked point on fabric
5. Set cursor
6. Pan
7. Zoom to all
8. Zoom to hoop
9. Zoom to cursor
10. Move
11. Set cursor point
12. Fine tuning controls

Zoom Options

Use the different zoom options to zoom in on your design(s). You can also use the zoom slider. When using the zoom to cursor it will maximize the zoom and pan the embroidery area so the cursor position is centered on the screen.



Zoom to all/Zoom to hoop/Zoom to cursor

Set Cursor Point

Move the cursor point to any of the selected corners or to the center of the design. The set cursor point can be used to trace the design field by touching each of the four corner icons. Find the center of the design by touching the set cursor point center icon.

Exact Position Exercise

Follow the instructions on screen.

I. Select a Locking Point on Screen

Move the cursor with your finger to the point in the design on your screen that you want to match to a point on your fabric/previous design. Fine tune with the fine tuning controls. If you want to place the locking point in a corner or center of the design, touch zoom to cursor to maximize the zoom and pan the embroidery area for exact position of the cursor.

2. Move Locked Point on Fabric

The cursor will be locked to the design. It will change color with a ring around the center of the locking point. Touch and move with your finger on the screen to position your design exactly where you want it to match on the fabric or to the previously stitched design. Use the fine tuning controls to fine tune. Watch the hoop until the needle is exactly where you want it to be on the fabric or the previously stitched design. The locking point on the fabric shows the position of the needle in the design.

Note: If you also need to adjust the angle of the design, continue with step 3.

3. Set Matching Point on Screen

Select another matching point on the design to match a second position on the fabric or previously stitched design. Touch and move the cursor on the screen to where you would like the matching point to be in your design. Fine tune with the fine tuning controls. Use zoom to cursor to maximize the zoom and pan the embroidery area for exact position of the cursor.

4. Rotate Design on Fabric

Rotate is automatically selected. Touch and move using your finger on the screen, or use the fine tuning controls, to rotate the design until the needle is exactly where you want it to be on the fabric or the previously stitched design.

Projection in Embroidery Stitch-Out

You can use the projector as a help when positioning a design on the fabric. Maybe you want to cover a stain, place another design in relation to an already embroidered one, or put your design on, for instance, a pocket.

When the projection is activated, the projector will show an image of the embroidery design(s) to be projected onto your hooped fabric. The cross hair shown on the screen corresponds to the machines needle position.

The projector has a projection area of approximately 4" x 2.4"(10x6cm) in front of the needle. If the embroidery design is larger than the projection area, the part of the design(s) that fits inside the projection area is shown on the fabric. You can move the position of the projection area by using the move hoop. By touching the positioning arrows, the cross hair on the screen and the hoop moves simultaneously to your desired position. The embroidery projection updates as you edit the position, orientation, color, etc. of the selected embroidery design.

Note: The embroidery arm and hoop will move when using the move hoop control, make sure the area around the embroidery unit is cleared.

Save Current State/Restore Current State

If you want to stop embroidering and save your current position, touch start/stop to stop the embroidery. Then touch the save icon. There you have the option to save current state. You can now turn your machine off.

When saving current state, all your adjustments are stored and you can continue the embroidery later by touching “continue from saved state” at the home screen.

Note: You can only have one current state at a time.

Auto Save

When embroidering, your machine will continuously and automatically save your ongoing work, including the current stitch, current embroidery, current stitch position and settings. If there is a power outage when you are in embroidery stitch-out a pop-up will appear when your machine is restarted. In the pop-up you can choose to return to embroidery stitch-out and bring up the design ready to stitch. The embroidery will start from approximately the same position as it was interrupted from.

Note: Before starting the embroidery go back a few stitches using the step stitch-by-stitch control to ensure that the threads will be secured.

Pop-up Messages in Embroidery Stitch-Out

To make your experience as convenient as possible, your machine sometimes communicate with you using pop-up messages. Those messages can contain warnings, recommendations, information or prompt you to perform an action.

Below, some of the messages that can appear are listed and explained.

The Embroidery Arm Needs to Calibrate

When the embroidery unit is attached, a pop-up message will appear and inform you to slide off the hoop and clear the machine area for calibrating the embroidery arm. You will also be reminded to disengage the IDF System and attach a suitable embroidery foot.



It is very important to remove the hoop, otherwise the hoop or the embroidery unit may be damaged while calibrating.

Bobbin Thread Low

When the bobbin thread is running low, a pop-up message appears giving you advance notice that you will soon need to change the bobbin. This gives you an opportunity to plan when you want to change your bobbin.

It is possible to embroider until the thread has completely run out. Without closing the pop-up, touch the Start/Stop button, on the front of the machine or the foot control to continue embroidering.

Touch cancel to remain at the current stitch position.

Touch OK to move the hoop to the center position. The hoop position pop-up opens. Replace the empty bobbin with a full one. Touch current position in the pop-up and pull back any excess length of needle thread. Touch the start/stop button to continue embroidering.

Cut and Remove the Thread Tail

After changing the thread, the machine will sew a few stitches and then stop so you can cut the thread tail.

Note: When automatic thread cutter and automatic jump stitch trim function is selected in embroidery settings, the thread will be cut automatically and no cut thread tail pop-up will be shown. Simply remove the thread tail that has been cut.

Change Thread

When it is time to change the upper thread, the machine will stop. Change the spool of thread and re-thread the machine. The recommended thread color number is shown in the pop-up message.

Your Embroidery is Finished

A pop-up message and sound informs you that your embroidery is finished. When the pop-up is closed the design will stay loaded in embroidery stitch-out and you can stitch the same embroidery again, including any changes you have made.

Attach Hoop

If the hoop attached to the machine does not match the hoop that is selected and displayed on the screen, the machine will not embroider. You must change the hoop to the one displayed on the screen or return to embroidery edit and select the hoop to match the attached hoop.

The hoop needs to be inserted properly for the machine to detect it. Slide the hoop connector into the hoop attachment from front to back until it clicks into place.

Change Needle (Optional Accessory)

Cutwork designs and felting designs require special optional needle accessories.

When the machine stops and this pop-up message is shown, insert the corresponding optional needle. Touch OK and press the start/stop button to resume.

Cutwork designs are marked with a cutwork needle symbol and felting designs are marked with a felting needle symbol in the DESIGNER EPIC™ 3 sampler.

Note: Cutwork designs can also be stitched out without using the cutwork needles. The cutwork area will then have to be cut manually and the color block for the cutwork needle in the color block list should be skipped.

Check Upper Thread

The machine stops automatically if the upper thread runs out or breaks. Re-thread the upper thread from the beginning, close the pop-up message and then go back a few stitches using the Step Stitch-by-Stitch control to ensure that the thread will be secured. Re-start your embroidery.

Attention!

If the machine stops and this pop-up appears on the screen you cannot continue embroidering. Wait a moment and touch OK when it is enabled. Check needle size and condition and check that your machine is threaded correctly.

Auto Smart Save

If a power outage has occurred, you will see this pop-up message when the machine is restarted. Touch OK in the pop-up to return to embroidery stitch-out. This will load the design ready to stitch from approximately the same position it was interrupted.

Tip: Before starting the embroidery go back a few stitches using the step stitch-by-stitch to ensure that the threads will be secured.

II Sequence



Sequence – Overview

In sequence, you can create and adjust a sequence of stitches. Combine various 9mm stitches, side-motion stitches and stitch fonts from the machine, the mySewnet cloud or from a USB device. Stitches made in IDF System feature can also be inserted in a sequence. You can create sequences up to approximately 500mm (20”) long. You can see how long your actual sequence is in the information area.



Touch to open Sequence

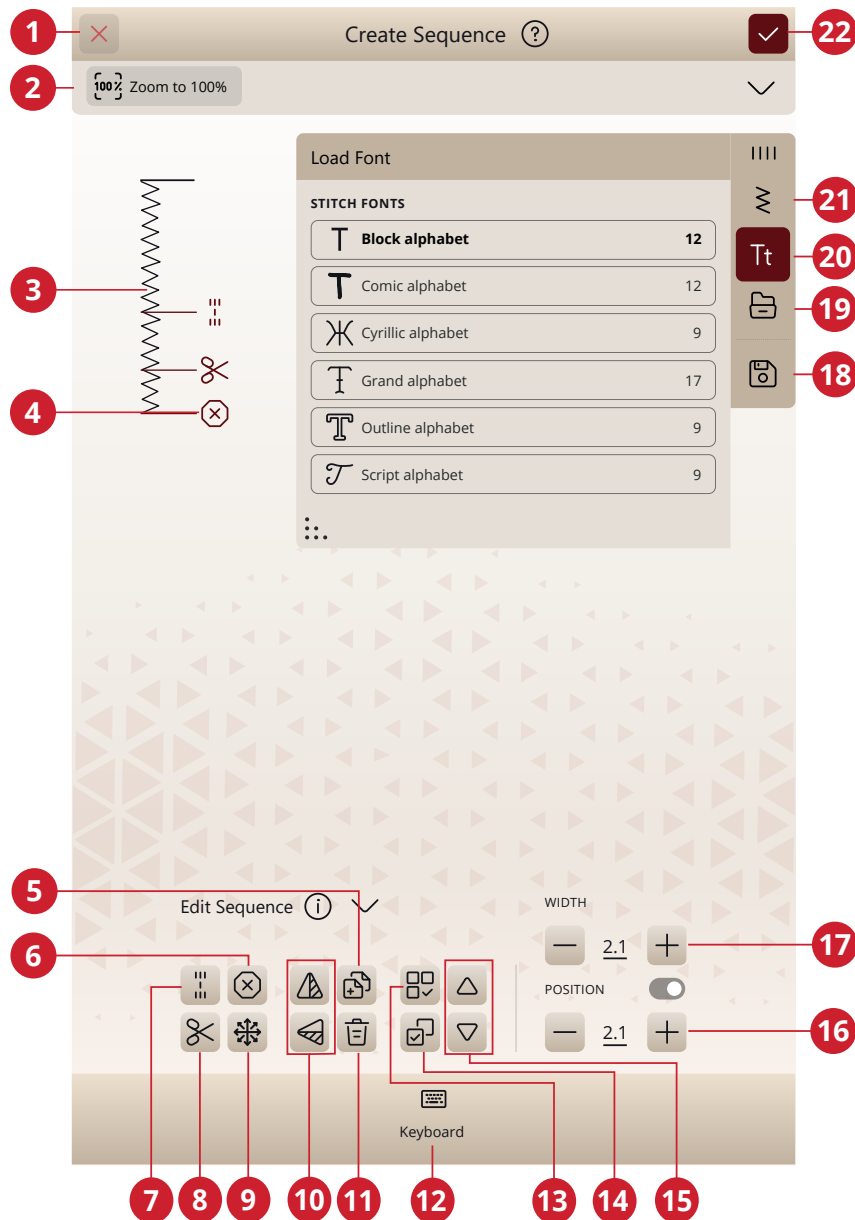

- | | | |
|----------------------------|---|-------------------------------------|
| 1. Cancel | 9. Directional stitches | 16. Stitch length/stitch density |
| 2. Zoom options | 10. Mirror side to side/mirror end to end | 17. Stitch width/stitch positioning |
| 3. Sequence in actual size | 11. Delete | 18. Save |
| 4. Inserted commands | 12. Keyboard | 19. File manager |
| 5. Duplicate | 13. Select all | 20. Font menu |
| 6. Stop command | 14. Select multiple | 21. Stitch menu |
| 7. Tie-off command | 15. Step between stitches | 22. OK |
| 8. Thread cut command | | |

Getting Started with Sequence

To start creating a sequence, select a desired stitch and/or letter and add it to the sequence. The active position is marked by a cursor and the selected stitch or letter will be highlighted. Only the selected stitch/stitches can be adjusted. Inserted stitches will be placed at the cursor position.

Touch select multiple to select several stitches in a sequence.
Touch select all to select all stitches.

Move the cursor through the sequence using the arrows. The number of selected stitch and total number of stitches in the sequence are shown between the arrows. When sewing a sequence it is possible to start sewing anywhere in the sequence. Use the arrows to step through the sequence.

Note: Buttonholes and 4-way stitches cannot be programmed.

Directional Stitches

Add directional stitches between stitches in a sequence. These stitches makes it possible to move stitches in various directions and you can create new shapes and wider large-area borders.

Directional stitches are straight stitches with a length of approximately 1mm and can be used in 16 different directions.

Touch your intended angle and one stitch will be inserted in the sequence at the cursor position.

The directional stitch can be deleted, duplicated or mirrored without closing the directional stitches pop-up.



Edit and Adjust Your Sequence

Adjust Stitch Settings

You can adjust the length and width of the stitch or change the density or position of the selected stitch. The adjustments work just like in sewing mode.

Duplicate

To duplicate a stitch, move the cursor to the stitch you want to duplicate. Touch the duplicate icon to copy the selected stitch.

Note: If you make adjustments on the stitch before duplicating, the copied stitch includes the adjustments.

Touch & hold to get a pop-up where you can enter the exact number of copies you want to insert.

Delete

If you want to delete a stitch or letter, touch the stitch or move the cursor to the stitch or letter you want to delete and touch delete. Touch & hold to delete the whole sequence.

Sequence Commands

You can insert tie-off, stop and thread cut commands into the sequence. These commands will be included in the sequence and will always be performed when sewing it.

Use the tie-off command if you want a secure tie-off. You can insert the tie-off commands anywhere in the sequence.

Note: If creating a sequence in embroidery mode, tie-off at the beginning and end will be added automatically, allowing you to create a sequence in between. The commands can be removed.

Insert a stop command if you want the machine to stop. This is useful for example at the end of the sequence if you want to sew it only once or to create a sequence in several rows.

Insert a thread cut command if you want the machine to tie-off and cut the threads and raise the presser foot.

Move the cursor to the position where you want to add a command. Select it and an icon will be added into the sequence. This confirms that the command is inserted and it also shows where the command will be performed in the sequence.

Note: The commands will appear on the screen in the order you program them.

Saving a Sequence

To save your file, touch save. You can choose to save the file to the mySewnet cloud folder or to a USB device. Previously saved designs, stitches, sequences and/or fonts are shown.

Learn how to organize your saved files in File Manager.



Save button

Sew or Embroider Your Sequence

To sew your stitch sequence, load it to sewing mode by touching OK in sequence.

If you have opened sequence in embroidery edit, touching OK will load your sequence to embroidery edit.

Note: A sequence created in embroidery mode will be loaded and saved as a design and can not be sewn as a stitch in sewing mode.

Adjust the Entire Sequence

To adjust the entire sequence, enter sewing mode by touching OK. Adjustments made in sewing mode will affect the entire sequence. Read about edit stitch.

Using Sequence in Sewing Mode and Embroidery Edit

In sewing mode it is possible to start sewing anywhere in the sequence. Use the arrows to step through the sequence. In sewing mode you can edit your entire sequence.

If you are in sewing mode and want to edit a stitch in the sequence, touch “edit in sequence” and the stitch will open in sequence. Make your adjustments and touch OK to load it to sewing mode again. Touch cancel to undo.

Note: Touch and hold in the stitch field area to open the smart toolbox to access edit in sequence.

In embroidery edit you can make changes to your sequence just like when editing a design.

If you want to edit a sequence loaded to embroidery edit touch the sequence and sequence will be highlighted. Touch to open sequence again. Make your adjustments and touch OK to load it to embroidery edit. Touch Cancel to undo.

Pop-up Messages in Sequence

To make your sewing experience as convenient as possible, your machine sometimes communicate with you using pop-up messages. Those messages can contain warnings, recommendations, information or prompt you to perform an action.

Below, some of the messages that can appear are listed and explained.

Stitch Cannot be Added in Sequence

Some stitches are not possible to insert in a stitch sequence, for example buttonholes and special stitch menus such as 4-way stitches.

Maximum Number of Stitches Has Been Reached

The stitch you are trying to add will make the stitch sequence too long. Your stitch sequence can be up to approximately 500 mm (20”) long and contain up to 199 stitches and commands. If the stitch sequence exceeds the maximum length this pop-up message will appear.

I2 Settings



Sewing Settings

deLuxe™ Stitch System

When the *deLuxe™* Stitch System is selected your machine will automatically choose the best way to control the upper thread, by thread portioning or thread tension, based on your selected stitch and settings. Thread portioning automatically and continuously measures the fabric thickness to meter the correct amount of thread for the selected stitch. When using thread tension, the tension discs will keep the correct amount of tension on the upper thread.

For best results we recommend you keep this setting selected except when using specific accessories or special techniques that do not support thread portioning.

Automatic Presser Foot Lift

When selected, the machine automatically raises the presser foot in the following situations:

- When stopping with the needle in the down position the presser foot will automatically raise to pivot height.
- After a thread cut the presser foot will be raised to lift position.

When deselected, the presser foot will stay lowered, even if the machine stops with the needle in down position.

Automatic Thread Cutter

When selected, the threads are cut automatically in the following situations:

- At cut commands in stitches and sequences.
- After sewing a single stitch e.g. a monogram or eyelets.

If deselected, no automatic thread cut will be performed.

Note: Deselect when using optional accessories that are attached in the two holes in the needle plate just above the bobbin cover, to prevent damage to the automatic thread cutter knife located under the needle plate.

Free-Motion Options

Choose between several free-motion options; free-motion floating, free-motion spring action and free-motion ruler foot. When one of the free motion options is selected the corresponding free motion mode will automatically be selected in sewing mode for all new projects loaded from the JoyOS ADVISOR™ feature.

It is recommended that you do not set an option for free motion in sewing settings; choose an option in sewing mode instead.

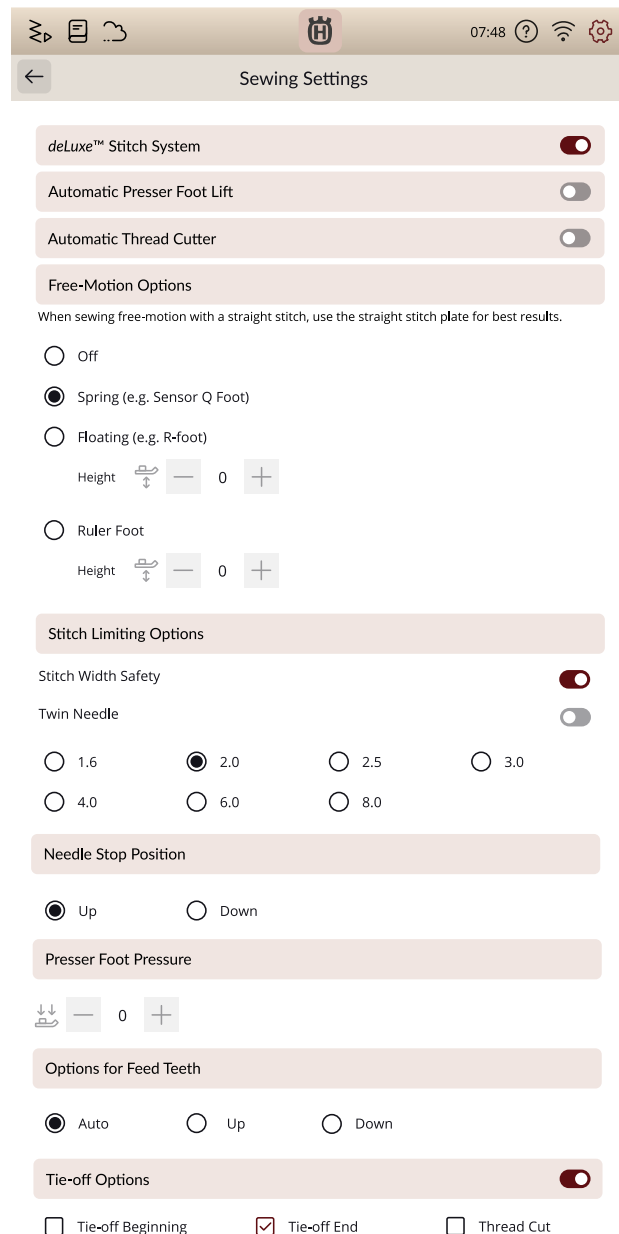

Stitch Limiting Options

Set the machine to stitch width safety or select the size of the twin needle to limit the stitch width and stitch positioning. This will minimize the risk of breaking a needle when sewing with accessories that do not allow the use of the entire stitch width.

Needle Stop Position

When up is selected your machine stops with the needle up. When down is selected your machine stops with the needle down.

This setting can also be set by touching the needle up/down button on the front of the machine.

Presser Foot Pressure

In most cases, you do not need to adjust the presser foot pressure. Specialty techniques may require an adjustment. The higher the number the more pressure on the fabric.

Options for Feed Teeth

When auto is selected (recommended) your machine automatically raises or lowers the feed teeth, depending on the stitch and other selected settings. For example, the feed teeth are lowered when sewing on buttons or when free-motion sewing.

Select up and the feed teeth will be raised for all sewing. Select down and the feed teeth will be lowered for all sewing.

Note: The machine will always lower the feed teeth automatically when raising the presser foot to extra lift position.

Note: The feed teeth options will automatically be reset to auto at the start of a new project from JoyOS ADVISOR™ or when restarting your machine.

Tie-Off Options

These options let you program a tie-off at the beginning and at the end of a stitch. It is also possible to program a thread cut at the end of a stitch.

Note: For immediate tie-off, use the tie-off button, found on the front of the machine.

Embroidery Settings

deLuxe™ Stitch System

When the *deLuxe™* Stitch System is selected your machine will automatically choose the best way to control the upper thread, by thread portioning or thread tension, based on your selected stitch and settings. Thread portioning automatically and continuously measures the fabric thickness to meter the correct amount of thread for the selected stitch. When using thread tension, the tension discs will keep the correct amount of tension on the upper thread.

For best results we recommend you keep this setting selected except when using specific accessories or special techniques that do not support thread portioning.

Deselect the *deLuxe™* Stitch System to switch to thread tension. The control for adjusting thread portioning/thread tension, will change depending on the active stitch and whether the *deLuxe™* Stitch System is selected or not in settings.

Embroidery Foot Type

Select either the Sensor Q-Foot or floating foot. It is very important that the correct setting is selected for the attached embroidery foot.

For best embroidery results, select and use the Sensor Q-Foot and the *deLuxe™* stitch system. This is strongly recommended. Some specific specialty techniques and/or accessories do not support the use of the Sensor Q-Foot, e.g. yarn couching and felting.

When the Sensor Q-Foot is selected the machine will lower the foot to hold the fabric at each stitch. When the floating foot is selected the machine will lower the foot to a pivot height above the fabric. When using a floating foot the presser foot height can be adjusted for improved performance when using different weights of material and/or embroidery threads.

Note: The embroidery foot type will automatically be reset to Sensor Q-Foot at the start of a new project from the JoyOS ADVISOR™ feature. Make sure you attach the Sensor Q-Foot or change the setting to floating foot (e.g. R-Foot).

Twin Needle Options

When a twin needle size is selected the *deLuxe™* Stitch System feature will automatically use thread tension. When embroidering with a twin needle the straight stitch plate needs to be removed as it cannot be used with a twin needle. The twin needle setting will automatically be set when loading a twin needle embroidery project from the project menu.

Note: It is very important to activate the twin needle setting when embroidering with a twin needle to prevent damage to the machine.

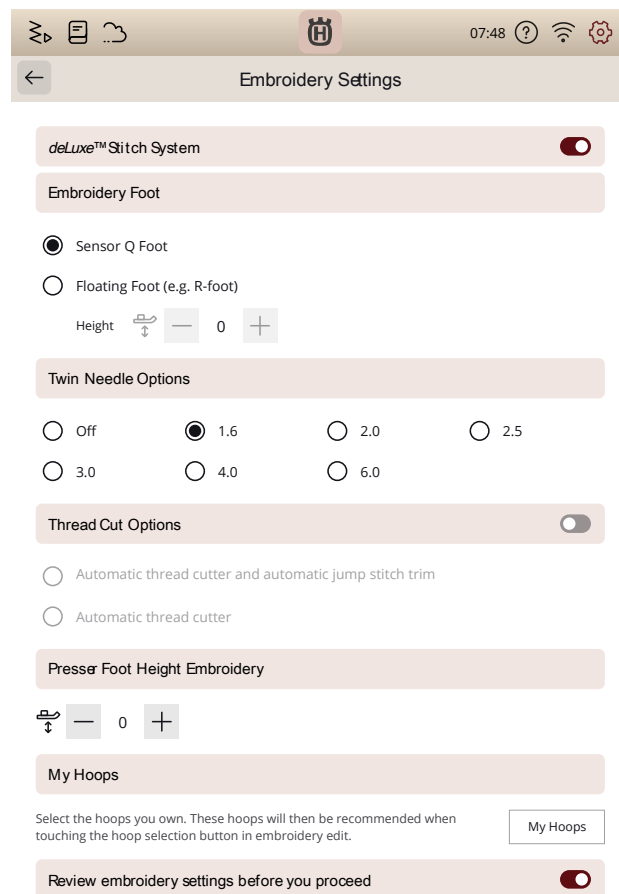

Thread Cut Options

Choose between three thread cut options: no thread cuts, automatic thread cut and a combination of automatic thread cut and automatic jump stitch trim.

Presser Foot Height Embroidery

When using the Embroidery/Darning Foot R, the presser foot height can be adjusted for improved performance when using different weights of material and/or embroidery threads.

Select Default Hoop Size

Touch to open a list of available hoop sizes. The selected hoop will be the default hoop when loading any design to the embroidery area, independent of the design size.

If no default hoop size has been selected your machine will choose the most suitable hoop for your embroidery.

Review Embroidery Settings

If you do not want to review your embroidery settings every time before you enter embroidery stitch out you can deselect this option.

Display & Audio Settings

All settings made in the machine settings will be saved, even when turning your machine off.

Language

Select your desired language. All texts in your machine will be changed after restart.

Time Format

Set if your clock show a 12- or a -24 hour format.

Time Zone

This is where you set your time zone. The clock is set to UTC (Coordinated Universal Time) standards. For exemple London is UTC time +/- 0 hours, New York is UTC -5 hours and Sydney is UTC +10 hours. Scroll through the time zones to find the time zone you are in.

Audio Volume

Change the audio volume using the slider bar. All sounds in your machine will be affected when the audio volume is changed. When the slider is all the way to the left, the volume is muted.

Audio Repeat

When active, the signal for some warning alerts or attention pop-up messages will be repeated in intervals until the pop-up is closed.

LED Work Light Brightness

Adjust the brightness of the LED lights to adapt to the light conditions in your sewing room. Simply move the slider to the right to make the LED lights brighter or to the left to make them less bright.

Units

Touch millimeter or inch to set the measurement unit you prefer.

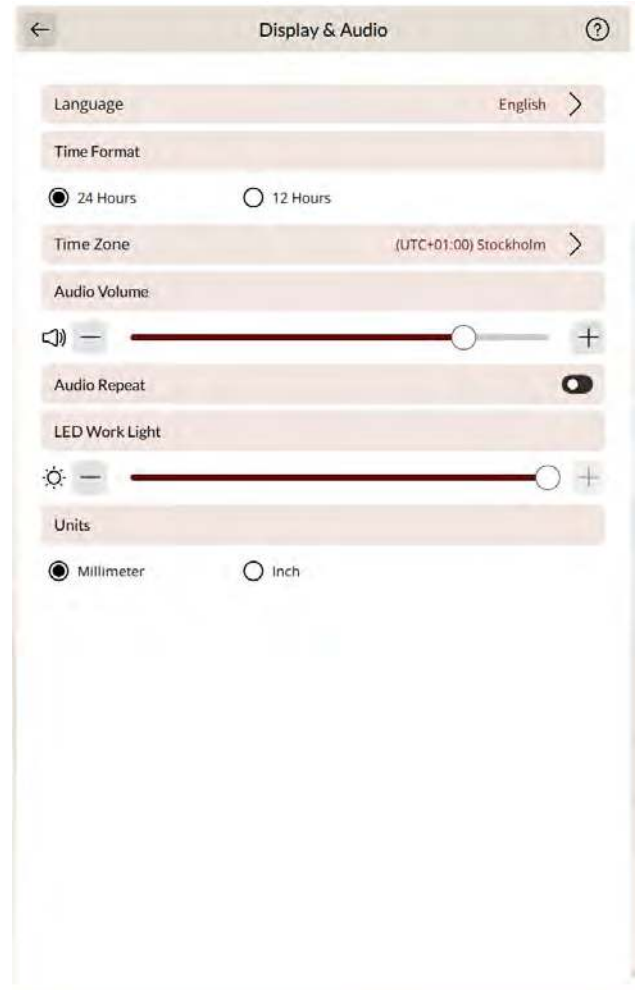

Personalize Settings

Machine Nickname

Touch to select a nickname for your machine. This can be useful when owning more than one machine, to distinguish one machine from another when working in mySewnet. The name will be shown on the screensaver.

Color Themes

Set your own favorite color theme to your machine.

Bottom Bar Text

Choose whether or not you want to have text together with your icons in the bottom bar.

Customize Your Workspace

Check this box to allow you to move around functions that are used often, and customize them on the screen.

Lock Screen

When selected, the screen is automatically locked whenever it is inactive for ten seconds. A pop-up is shown on the screen and the screen will remain locked until you touch OK in the pop-up.

Show Demo Mode

Activate to be able to access the feature videos directly on the home screen.

Play Feature Videos as Screensaver

When selected, the feature videos found in demo mode will be used as screensaver.

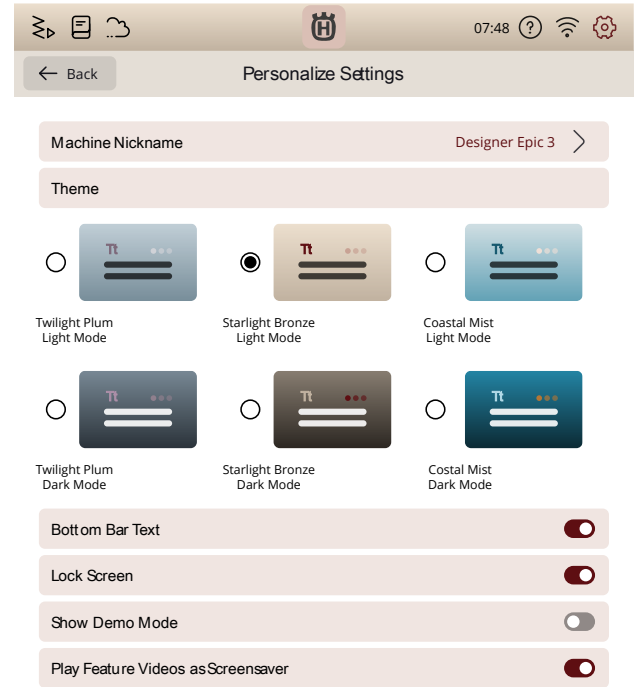

WiFi Settings

In WiFi settings you can activate/deactivate WiFi on your machine, search for available networks and connect. If connected to a network with internet access the latest firmware update will always be available. When WiFi is connected and you have logged in to the mySewnet cloud, all your saved files in the machine will synchronize with the mySewnet cloud.

Read more about the WiFi connection in your machine in the WiFi chapter.

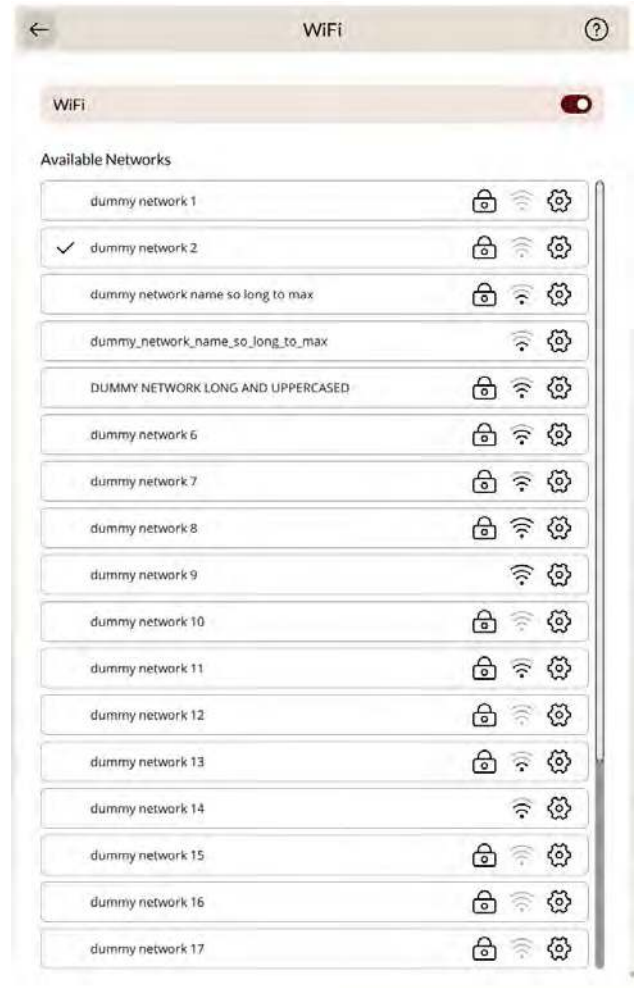

mySewnet Settings

In mySewnet settings you can sign in to your mySewnet account. With a mySewnet account you will be able to access all of the mySewnet services.

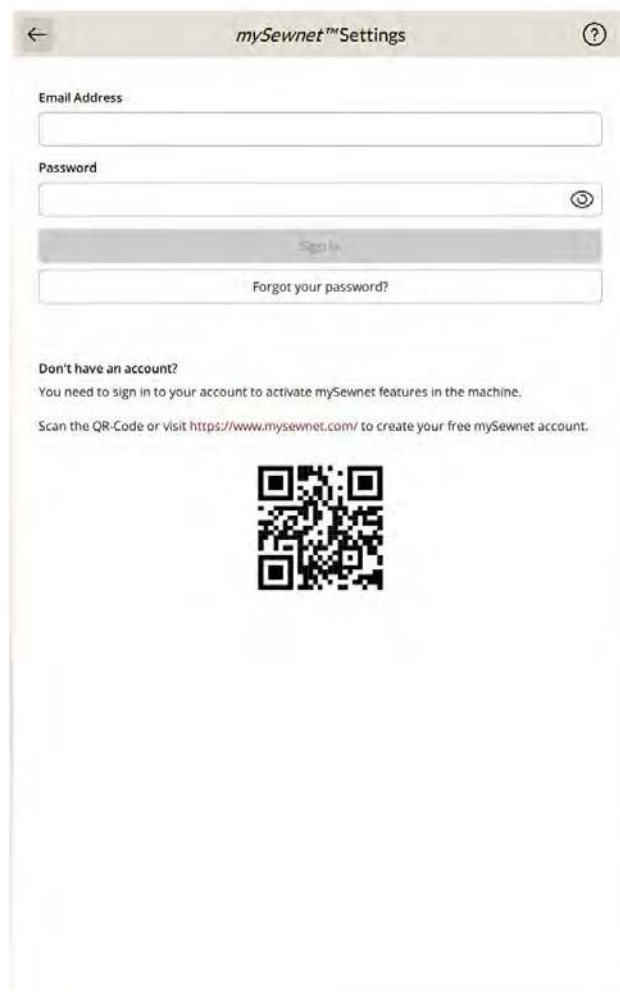

The screenshot shows the 'mySewnet™ Settings' app interface. At the top, there is a back arrow on the left and a help icon on the right. Below the title bar, there are two input fields: 'Email Address' and 'Password'. The 'Password' field has a toggle icon on the right. Below these fields is a grey 'Sign In' button. Underneath the button is a link that says 'Forgot your password?'. Further down, there is a section titled 'Don't have an account?' with the text 'You need to sign in to your account to activate mySewnet features in the machine.' and a link 'Scan the QR Code or visit <https://www.mysewnet.com/> to create your free mySewnet account.' Below this text is a QR code.

Camera and Projection Settings

Presser Foot Recognition

The presser foot recognition feature is using the camera and artificial intelligence (AI), with a neural network that makes predictions, so that your machine can recognize which presser foot is attached. If the presser foot predicted to be attached differs from the one recommended for the selected stitch, this will be indicated in the information area.

Note: The performance of the presser foot recognition feature can be affected by eventual alterations of a presser foot's appearance; due to room lighting, fabric reflectivity properties, position fluctuations, obstructions or physical alterations of the presser foot's surfaces.

Adjust Camera

After frequent use, transportation etc, the camera might need to be adjusted.

Touch fine tune to start the adjustment, then follow the directions given on your screen.

Adjust Projection

After frequent use, transportation etc, the projector might need to be adjusted to perform exact projection.

Touch fine tune to start the adjustment, then follow the directions given on your screen.



Machine Information

Machine information contains technical machine information such as: machine serial number, machine MAC address and current firmware. In machine information you can clear user account and files.

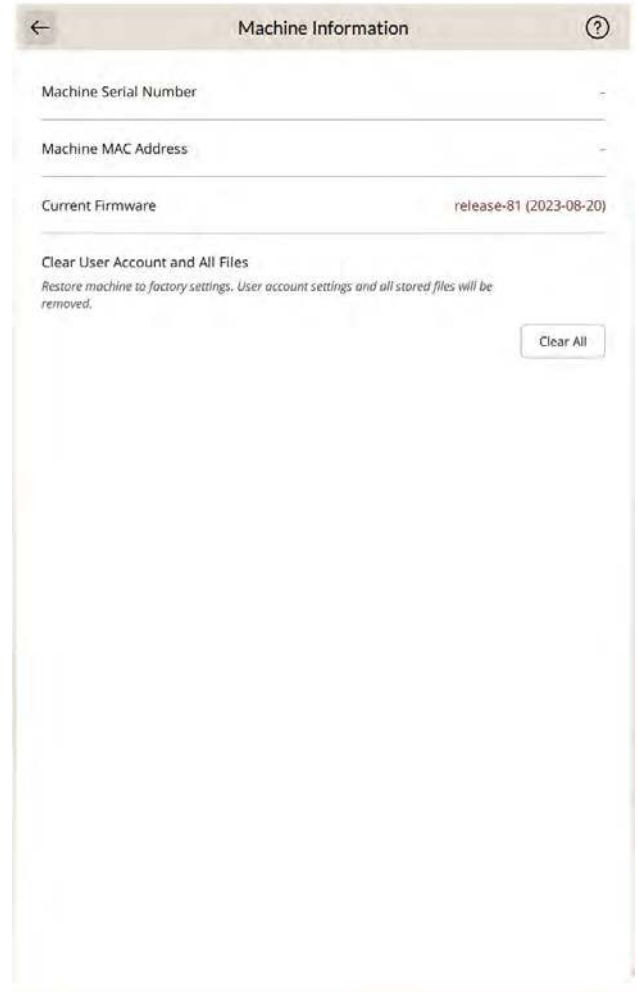

13 File Manager



File Manager – Overview

Touch the folder icon in the Menu Panel to open File Manager.

File Manager is used to open design files, font files and stitch files. Store your saved files in the mySewnet cloud folder or to a USB device connected to your DESIGNER EPIC™ 3 machine.

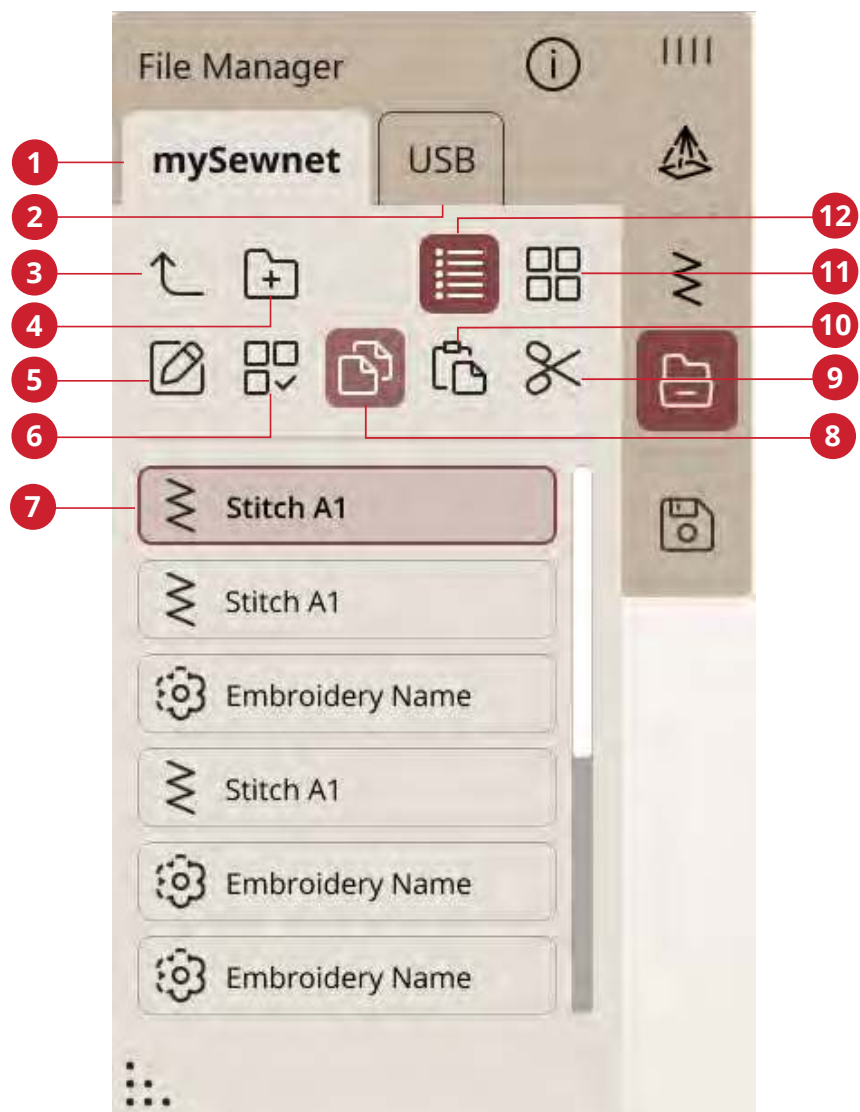

1. mySewnet folder
2. USB device
3. Move up one folder
4. Create new folder

5. Rename file or folder
6. Select multiple
7. Selection area
8. Copy

9. Cut
10. Paste
11. Delete
12. List/thumbnaill view

File Formats

Your DESIGNER EPIC™ 3 machine can load the following file formats:

- .VP4, VP3, .SHV, .DHV, .VIP, .HUS, .PEC, .PES, .PCS, .XXX, .SEW, .JEF, .EXP, .10* and .DST (embroidery files)
- .SPX (stitch file)
- .VF3 (embroidery font file)
- .JOS, .VPP (project files)

Note: Some versions of the embroidery files are not fully supported by your machine.

Note: If the file type or file version is not supported by your machine, or the file is damaged, it is shown in the selection area as an unrecognized file.

Browse File Manager

Store your designs, fonts and stitches in the mySewnet folder or to a USB device connected to the USB ports. The USB Device is only available when a USB device is connected to your machine.

To display the content, touch the mySewnet cloud folder or USB Device. Swipe with your finger upwards and downwards to scroll and view the content. Design files and font files are displayed as thumbnail images or with an icon depending on if you have list view or thumbnail view selected.

Open a File or Folder

Touch a file to read information about the file in the file information area. Touch & hold the file to load it.

If you load an embroidery font file, it will be loaded into embroidery edit. If you load a stitch font file, it will be loaded into sequence.

Touch & hold on a folder to open it. The content of the folder will be shown in the selection area.

Select Multiple

If you want to select several designs, stitches or fonts at one time, touch the select multiple icon. While select multiple is activated, touch the files you want to use.

Note: If you try to load a variety of file/folders at the same time that open in different modes/ screens, a pop-up message will be shown.



mySewnet Folder

Save designs, stitches and fonts to the mySewnet cloud folder on the machine. If you are signed in to a mySewnet account and connected to mySewnet your saved files will be synchronized automatically with the mySewnet cloud.

USB Device

The USB Device menu is only active when a USB device is connected to the machine. Touch the USB Device menu to display all of the connected devices. Touch a USB Device to explore it.

The files visible in the USB section is listed in File Formats.

Note: If you choose Delete All while in USB, it will delete all the files on your USB, even the ones not visible on the machine.

List/Thumbnail View

Touch the list/thumbnail view icon to toggle between showing the files in a list or as thumbnail icons. In list view each file is shown with the file name and file type. In thumbnail view each file is shown with file name and a thumbnail image of the file.

In list view all files are sorted in the following categories; folder, design, pattern, embroidery, font, stitch font, project, sounds and image. This makes it easier to find a specific file if you have many different file types in the same folder.



List view/thumbnail view

Move up One Folder Level

Use the move up one folder level icon to step up through the levels of folders. You can step up all the way to the first level. In the selection area you will see the files and folders for each level as you step up. Touch & hold on a folder to open it.

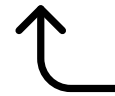

Move up One Folder Level

Organize

Below are instructions on how to organize your files in file manager.

Create New Folder

Touch the create new folder icon to create a new folder in the current position. A pop-up message opens where you can enter a name for your folder.



Create New Folder

Rename a File or Folder

To change the name of a file or folder, touch to select it and then touch the rename file or folder icon. A pop-up message opens where you can enter the new name for a file or folder.



Rename

Move a File or Folder

Use cut and paste to move file(s) or folder(s) to another location.

Select the file(s) or folder(s) and then touch the cut icon. Open the folder where you want to place the selection. Touch the paste icon. The file(s) or folder(s) is removed from its original location and now stored in the new folder.

Note: Activate select multiple to be able to select and move more than one file and/ or folder the same time.



Cut



Paste

Copy a File or Folder

Use copy and paste to copy file(s) or folder(s) to another location.

Select the file(s) or folder(s), then touch the copy icon. Open the folder where you want to place the selection. Touch the paste icon. The file(s) or folder(s) is now stored in the new folder and the original file(s) or folder(s) still exists in the previous folder.

Note: Activate select multiple to be able to select and move more than one file and/ or folder at the same time.



Copy



Paste

Delete a File or Folder

To delete a file or folder, select it and touch the delete icon. A pop-up message will appear so that you can confirm the deletion. If a folder is deleted, all files within the folder are deleted as well.

To delete all files and folders shown in the active folder, touch & hold the delete icon for a few seconds. A pop-up message will appear so that you can confirm the deletion of all content.

Note: If you choose Delete All while in USB, it will delete all the files on your USB, even the ones not visible on the machine.



Delete

Pop-up Messages in File Manager

To make your experience as convenient as possible, your machine sometimes communicate with you using pop-up messages. Those messages can contain warnings, recommendations, information or prompt you to perform an action.

Below, some of the messages that can appear are listed and explained.

Do You Want to Delete?

When deleting a file or folder, you will need to confirm the deletion in the pop-up message that appears on screen. This will prevent you from deleting anything by mistake.

Not Enough Available Memory

When only a small amount of space is left, your machine will alert you one time. If you continue to fill the space, it will not remind you again, until the space is completely full. Move your files to a USB device by using the cut and paste functions to free up space.

Folder Already Exists

You cannot create a new folder with the same name as another folder on the same level. Create your folder on a different level or enter a different name for the folder.

The Combination of Selected File Types Cannot be Loaded

Some file combinations can not be loaded to the same destination using select multiple.

I4 Maintenance



Cleaning the Machine Exterior

To keep your sewing machine operating well, clean it often. No lubrication (oiling) is needed.

Wipe the exterior surface of your machine with a soft cloth to remove any dust or lint built up.

Wipe the screen with a clean, soft and slightly damp microfiber cloth.

Removing the Needle Plate and Cleaning the Bobbin Area

 Lower the feed teeth by touching the presser foot up and extra lift button. Turn off the machine.

Remove the presser foot. Open the bobbin cover by pushing the release button (A) to the right. Remove the cover. Place the universal tool under the needle plate as shown and gently turn the universal tool to pop off the needle plate. Clean the feed teeth with the brush that is included with the accessories.

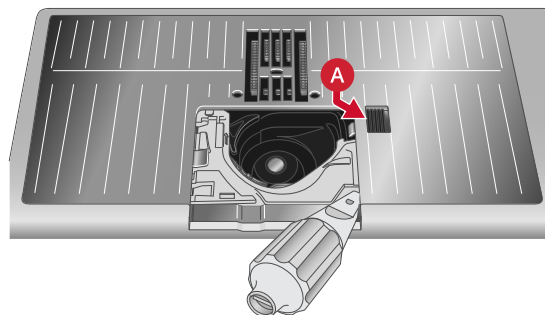

Cleaning Under the Bobbin Area

Clean the area under the bobbin case after sewing several projects or any time you notice an accumulation of lint in the bobbin case area.

Remove the bobbin case holder (A) covering the front part of the bobbin case by lifting it up. Remove the bobbin case (B) by lifting it up. Clean with the brush.

 Use caution when cleaning around the automatic thread cutter knife (C).

Put the bobbin case and the bobbin case holder back in place.

Note: Do not blow air into the bobbin case area. The dust and lint will be blown into your machine.

Note: When using optional accessories like cutwork and/or felting needles, it is necessary to clean the bobbin area after each embroidered design/project.

Note: Regularly clean the lint and threads from the bobbin area. Check the area when changing the needle plate.

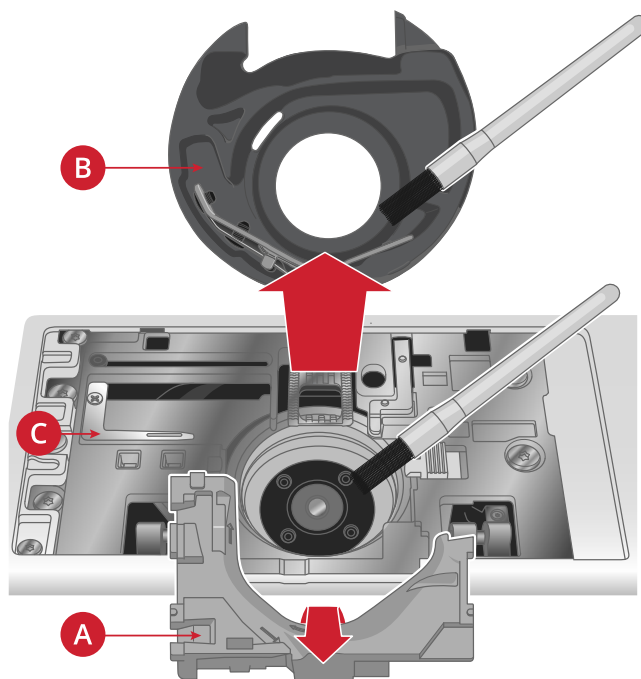

Replacing the Needle Plate

With feed teeth lowered, position the needle plate so that it fits into the notches at the back (A). Press the needle plate down until it clicks into place. Replace the bobbin cover.

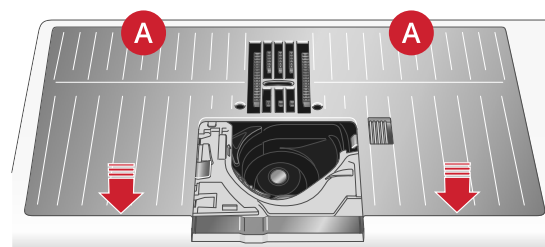

Troubleshooting

In this troubleshooting guide you will find solutions to the problems you may have with your machine. For further information please contact your local authorized HUSQVARNA® VIKING® retailer who will be happy to help you.

General Problems

Bobbin alarm does not work	Clean lint from bobbin area and use only the original HUSQVARNA® VIKING® bobbins designed especially for this model.
Thread cutter does not cut the thread	Remove needle plate and clean lint from bobbin area. Enable automatic thread cutter in the settings menu.
Fabric does not feed	Make sure the machine is not set for Free-Motion sewing. Make sure the feed teeth are not set to down in the settings menu.
Wrong stitch, irregular or narrow stitch	Deactivate twin needle or stitch width safety in the settings menu.
The needle breaks	Insert needle correctly as described, see page 32. Use a needle suitable for selected fabric. See chart at page 36.
The machine will not sew	Check that all plugs are securely inserted into the machine and the wall socket.
Poor sewing/embroidery result	Use only accessories designed for your DESIGNER EPIC™ 3 machine. Follow the on-screen recommendations.
The sewing and embroidery machine screen and/or function buttons do not respond to touch	The sockets and function buttons on the machine can be sensitive to static electricity. If the screen does not respond to touch, turn the machine OFF and then ON again. If the problem persists, contact your authorized HUSQVARNA® VIKING® retailer.
When sewing in heavy and/or dense fabrics the machine emits a distinct sound different from the sound normally generated when sewing.	The sound is not an indication of malfunction. The machine is equipped with a pulsating needle piercing feature that helps the needle to penetrate heavy and/or dense fabrics. The sound is caused when the presser foot and fabric lift with the needle. Increase the presser foot pressure to prevent the foot from lifting. If the sound does not seem to be related to the pulsating needle piercing feature, contact your authorized HUSQVARNA® VIKING® retailer for service.
The camera lens is dirty/blurry	If the Camera lens gets dirty or blurry please contact your authorized HUSQVARNA® VIKING® retailer for service.
The projection is blurry	If the projection is blurry please contact your authorized HUSQVARNA® VIKING® retailer for service.

The Automatic Needle Threader Does Not Work Properly

The needle eye is too small for the thread	Use a larger needle size or lighter weight thread. See chart at page 36.
Are you using a specialty thread such as an “invisible” or other stretchy thread, metallic or flat metallic thread or heavy weight thread?	Specialty threads may not be caught correctly by the hook on the automatic needle threader. If this happens, the needle will not be threaded. Try using the automatic needle threader again or thread the needle manually.

Pop-up message: The automatic needle threader is not in its home position. Touch OK to calibrate.	The needle threader has shifted from its home position, possibly due to something snagging on it during sewing or embroidery. Touch OK to calibrate the needle threader and continue sewing or embroidering.
Pop-up message: The calibration of the automatic needle threader has failed. Touch OK to calibrate again. If the automatic needle threader still does not calibrate correctly, please contact your local authorized service center.	Shown if the machine fails to calibrate the needle threader when turning on the machine. Remove anything that may be blocking the needle threader and touch OK.
Pop-up message: The automatic needle threader seems to be blocked and cannot return to its home position. Touch OK to move the automatic needle threader to position for manual cleaning.	If using thread that is too thick for the needle, the automatic needle threader may not be able to pull the thread through the needle eye. Touch OK to go to manual cleaning. A new pop-up message with further instructions will appear. If you cannot identify the problem or are unable to remove the thread, touch cancel.
Pop-up message: Gently remove any thread that is stuck in the automatic needle threader or needle eye. Touch OK to return the automatic needle threader to its home position.	If using thread that is too thick for the needle, the automatic needle threader may not be able to pull the thread through the needle eye. Remove the thread carefully so as not to damage the small hook that runs through the needle eye. Once the thread is removed, touch OK.
Pop-up message: The automatic needle threader is not in its home position. Further sewing is disabled to prevent damage to the machine. After closing this pop-up, touch the automatic needle threader button on your machine to try threading again or contact your local authorized service center.	Contact your authorized HUSQVARNA® VIKING® retailer for service.
Pop-up message: The automatic needle threader cannot return to its home position. Further sewing is disabled to prevent damage to the machine. Please contact your local authorized service center.	Contact your authorized HUSQVARNA® VIKING® retailer for service.

The Machine Skips Stitches

Did you insert the needle properly?	Insert needle correctly as described, see page 32.
Did you insert a wrong needle?	Use needle system 130/705 H. Use a needle suitable for selected fabric and thread. See chart at page 36.
Is the needle bent or blunt?	Insert a new needle (page 32).
Did you thread the machine properly?	Remove the thread completely and rethread the machine, see page 33.
Is the correct presser foot used?	Attach correct presser foot.
Is the needle too small for the thread?	Change the needle (page 32).
Is the fabric moving up and down with the needle when Free-Motion sewing or embroidering?	Attach Sensor Q-Foot (page 44). If using the R-Foot, increase the embroidery pivot height in settings menu in small increments until the problem is solved.

Needle Thread Breaks

Did you insert the needle properly?	Insert needle correctly, see page 32.
Did you insert a wrong needle?	Use needle system 130/705 H. Use a needle suitable for selected fabric and thread. See chart at page 36.

Is the needle bent or blunt?	Insert a new needle (page 32).
Did you thread the machine properly?	Remove the thread completely and rethread the machine, see page 33.
Does the thread slide down and get caught under the thread spool?	Place the large spool holder with the flat side up under the spool on the spool pin, or for larger spools use a thread net over the spool. See Threading Tips and Hints, page 39.
Is the needle too small for the thread?	Change the needle to the proper size for the thread.
Are you using poor thread with slubs or thread which has become dry?	Change to a new high quality thread purchased from an authorized HUSQVARNA® VIKING® retailer.
If using a spool cap on top of the spool, is it too small so the thread snags at the top of the spool?	Attach a spool cap slightly larger than the actual thread spool.
Is the best spool pin position used?	Try a different spool pin position (vertical or horizontal).
Is the needle plate hole damaged?	Change the needle plate (page 45).
Is the thread tension too high for selected thread?	Lower the thread tension in small increments until problem is solved.

Bobbin Thread Breaks

Is the correct bobbin used?	Use only bobbins especially designed for the DESIGNER EPIC™ 3 machine.
Did you insert the bobbin properly?	Check the bobbin thread.
Is the needle plate hole damaged?	Change the needle plate (page 45).
Is the bobbin area full of lint?	Clean lint from bobbin area and use only the original bobbins approved for this model.
Is the bobbin wound correctly?	Wind a new bobbin (page 40).

The Seam has Uneven Stitches

Is the thread tension correct?	Check needle thread tension. Remove the thread completely and rethread the machine, see page 33.
Is the thread you are using thick or slubbed?	Change the thread.
Is the bobbin thread evenly wound?	Check bobbin winding.
Is a correct needle used?	Insert a proper needle correctly as described, see page 32. Use a needle suitable for selected fabric. See chart at page 36.

The Machine Does Not Feed or Feeds Irregularly

Did you thread the machine properly?	Remove the thread completely and rethread the machine, see page 33.
Has sewing lint collected between the feed teeth?	Remove the needle plate and clean the feed teeth with the brush (page 156).
Is the Free-Motion setting on?	Turn off Free-Motion setting in sewing mode.
Are the feed teeth set to down?	Make sure the feed teeth are not set to down in the settings menu.
Is the correct presser foot used?	Attach correct presser foot.

Thread Loops are Forming on the Underside of the Embroidery Design

Has the embroidery built up too much to move freely under the presser foot?	Attach the Sensor Q Foot (page 44). If using the Embroidery/Darning Foot R, increase the embroidery pivot height in settings menu in small increments until the problem is solved.
---	---

The Embroidery Design is Distorted

Is the fabric hooped properly?	The fabric must be tightly hooped (page 53). For larger hoops, use hoop clips.
Is the inner embroidery hoop properly inserted into the outer embroidery hoop?	Hoop the fabric in such a way that the inner hoop exactly matches the outer hoop (page 53).
Is the area around the embroidery arm and hoop free?	Clear area around the embroidery unit.
Is the hoop attached properly?	The hoop must be attached securely in the hoop connector on the embroidery arm (page 54). If using the hoop adapter, make sure the hoop connector is inserted all the way into the hoop adapter (page 54).

The Embroidery Design has Puckered

Did you stabilize your fabric sufficiently?	Ensure you use the proper stabilizer for your technique or fabric type.
---	---

The Machine will not Embroider

Is the embroidery unit attached?	Make sure that the embroidery unit is properly attached into the socket (page 50).
Is the wrong hoop attached?	Attach the correct hoop.

The Machine Cannot Connect to a WiFi Network

The machine will not connect to a WiFi network	Make sure that WiFi is enabled on your machine. Touch the WiFi button or go to WiFi settings. Make sure that the machine detects a signal from your WiFi network. If there is no signal, move the machine closer to the WiFi router. Make sure you have selected your WiFi network.
The machine has no Internet connection	Make sure that your WiFi router has access to the Internet.
The WiFi network is password protected	Make sure that you have selected your WiFi network and entered the correct password. If you do not know the password, contact the administrator of your network.

The Machine Cannot Synchronize with the mySewnet Cloud

<p>The machine cannot synchronize files with the mySewnet cloud</p>	<p>Make sure that you have a working WiFi connection.</p> <p>Make sure that you have signed in to your mySewnet account. New mySewnet accounts are registered at husqvarnaviking.mysewnet.com</p> <p>Make sure that there is available space on the mySewnet cloud.</p> <p>If the mySewnet cloud is not accessible although you have checked the WiFi connection, the server could temporarily be unavailable. Please try again later.</p>
---	--

Service

Have your sewing machine serviced regularly by your local authorized retailer!

If you have followed this troubleshooting information and still have problems, contact your retailer. It may be helpful to bring the fabric, thread and stabilizer you are using with you. If you have a stitch out that shows the problem, please bring that as well. A sewing sample will often give better information than words and help your technician diagnose the problem.

Non-Original Parts and Accessories

The warranty does not cover any defect or damage caused by use of non-original accessories or parts.

Technical Specification

DESIGNER EPIC™ 3 Household Sewing Machine

<p>Sewing Speed 1050 stitches/minute maximum</p>	<p>Rated Voltage 100–240V, 50–60Hz</p>	<p>Nominal Consumption <100W</p>
<p>Light Led Lights</p>	<p>Foot Control Model: FR5 Manufacturer: Shanghai Binao Precision Mould Co., Ltd</p>	<p>Safety Class II (Europe)</p>
<p>WiFi Module Frequency: 2.4 band / 802.11 b/g/n Transmitting power: +17 dBm Receiver sensitivity: -97 dBm</p>	<p>Machine Dimensions Length: 628 mm Width: 275 mm Height: 362 mm</p>	<p>Net Weight Machine only: ≈15 kg Embroidery unit: ≈8 kg</p>

The technical specifications and this user's guide can be changed without prior notice.

Index

1. Select a Locking Point on Screen	126
2. Move Locked Point on Fabric	127
3. Set Matching Point on Screen.....	127
4-Way Stitches	87
4. Rotate Design on Fabric.....	127
8-Way Stitches	87

A

Accessories	17
Accessory socket.....	13
Accessory Tray	14
Active Features	58
Add a Letter.....	110
Add a Stitch or Stitch Point.....	95
Adjust Camera.....	146
Adjust Projection	146
Adjust the Entire Sequence.....	135
Adjust Thread Tension/Thread portioning.....	78
Adjustable ¼" Foot for IDF System.....	18
All Purpose Sewing Thread.....	29
Alphabets	24
Apps.....	62
Attached Needle Plate.....	121
Attaching and Removing the Hoop	54
Attaching the Sensor One-Step Buttonhole Foot	44
Attaching the Sensor Q-Foot.....	44
Audio Repeat	142
Audio Volume	142
Auto Save	128
Automatic Buttonhole.....	85
Automatic needle threader.....	13, 15
Automatic Needle Threader.....	35
Automatic Presser Foot Lift.....	138
Automatic Thread Cutter.....	138
Auxiliary spool pin	12

B

Background Color.....	107
Balance	79
Base plate	12
Baste.....	83
Basting Options.....	121, 123
Blind Hem.....	84
Blindhem Foot D.....	18
bobbin case.....	156
bobbin case holder	156
Bobbin cover.....	12
Bobbin cover release button.....	12
Bobbin Thread Breaks	159
bobbin winder.....	40
Bobbin winder.....	13

Bobbin Winding	40
Bobbin winding lever.....	13
Bobbin winding thread guides	12
Bobbins.....	17
Browse File Manager	151
Brush.....	17
Button Stitch Repetition.....	78
Buttonhole Foot C	18
Buttonhole Slit Length.....	77
Buttonholes	85

C

Camera and Projection Settings	146
Cancel.....	57
Center marks.....	48
Center Position.....	125
Change Color	102
Changing the Needle	32
Changing the Needle Plate.....	45
Changing the Presser Foot.....	43
Check Upper Thread	90
Cleaning the Bobbin Area.....	156
Cleaning the Machine Exterior	156
Cleaning Under the Bobbin Area	156
Color Block List.....	123
Color Block Merge	123
Color Block Sort	123
Color Edit	101
Color Options	122
Color Themes	143
Combining Programs.....	82
Common Functions.....	57
Connect the foot control cord.....	26
Connect to a Network with WiFi.....	46
Connect to mySewnet Services	46
Connecting the Embroidery Unit.....	50
Control Points	116
Copy a File or Folder.....	153
Corded Buttonhole.....	85
Corner Check	124
Create a Text	110
Create Appliqué.....	114
Create New Folder	152
Create Shape	112
Current Stitch Position.....	125
Customize Your Work Area	57
Cut.....	15

D

Decorative Stitch Foot B	18
Definition of a Stitch Point	93

Delete a File or Folder	153
Delete a Letter.....	110
Delete Selected Stitch Point	94
Delete/Delete All.....	105
<i>deLuxe</i> [™] Stitch System.....	78, 122, 125, 138, 140
Denim Needle	31
DESIGNER [™] Jewel Hoop II (240x150mm).....	17
DESIGNER [™] Regal Hoop (465x260mm).....	17
DESIGNER [™] Royal Hoop II (360x200mm)	17
DESIGNER [™] Splendid Square Hoop II(120x120mm).....	17
Dimensional Stitches	87
Directional Stitches	133
Display & Audio Settings.....	142
Duplicate Selected Stitch Point	94
Duplicate/Multi Duplicate.....	104

E

Edge/Quilting guide.....	17
Edging Foot J for IDF System.....	18
Edit Functions.....	103
Edit Stitch.....	108
Edit Stitch in Stitch Creator [™]	94
Embellished Stitches.....	89
Embroider Your Resized Design.....	108
Embroidery arm	48
Embroidery Edit.....	97
Embroidery Edit — Overview	98
Embroidery Foot Type.....	140
Embroidery hoop attachment.....	48
Embroidery hoop connector.....	48
Embroidery Hoop Overview	48
Embroidery hoop release button.....	48
Embroidery Needle	31
Embroidery Settings	140
Embroidery Stitch-Out	119
Embroidery Stitch-Out – Overview.....	120
Embroidery Text.....	110
Embroidery Thread.....	30
Embroidery unit connector.....	13, 48
Embroidery Unit Extension.....	51
Embroidery Unit Overview	48
Embroidery/Darning Foot R	18
Exact Position	126
Exact Position Exercise.....	126
EXCLUSIVE SENSOR SYSTEM [™] EXCLUSIVE SENSOR SYSTEM.....	79
Extra wide space for Side-Motion Foot S	14

F

Fabric Selection	67
Fast forward.....	70
FAT32.....	27
Feature – Overview Stitch Creator [™]	92

File Formats.....	151
File manager.....	112, 114
File Manager	149
Firmware Update Using a USB Device	61
Firmware Update Using WiFi.....	60
Fixed Design Angle	116
Fixed Letter Angle.....	111
floating foot	140
Floating Stitches.....	89
Foot control socket	13
Free arm.....	13
Free Arm.....	27
Free Motion Options	79
Free mySewnet Embroidery Software (PC and MAC).....	62
Free-Motion Options.....	138
Full screen on/off.....	70
Function buttons	12
Function Buttons	15

G

General Problems	157
Getting Started with Sequence.....	133
Getting Started With WiFi	60
Getting Started with WiFi and mySewnet Cloud	46
Ghost Mode.....	123
Grid Options.....	107
Group/Ungroup.....	103

H

Hand wheel.....	12
Handle	13
Hem	84
high signal strength.....	60
Home	56
Home Screen— Overview.....	64
Hook for storing the Sensor One-Step Buttonhole Foot	14
Hook to attach the extension to the embroidery unit.....	48
Hooks to attach the extension to the machine	48
Hoop clips	17
Hoop Options.....	106
Hoop Position.....	125
Hooping the Fabric	53

I

Immediate tie-off	15
Important Needle Information.....	31
Important Resize Information.....	109
Included Accessories	17
Included Hoops.....	17
Indication of embroidery area.....	48
Information	58

Information and Sewing Recommendations	76
Inner hoop	48
Inserting the Bobbin	42
Integrated Dual Feed (IDF) System	13

J

JoyOS ADVISOR™	56
----------------------	----

K

Knit fabric	67
-------------------	----

L

Language	142
Large Hoop Support	51
Large spool holder	17
Layers	102
Leather	68
LED lights	12
LED Lights	27
LED Work Light Brightness	142
Left Side	13
Letter shapes	112, 114
Lid	12
List/Thumbnail View	152
Load a Design	99
Load a Font	99
Load a Stitch	73, 100
Load Autofill Stitch	115
Load Saved Files	100
Lock Screen	143

M

Machine Information	147
Machine Overview	12
Main Functions	56
Main spool pin	12
Manual Buttonhole	85
Manual Thread Cutter	28
medium signal strength	60
Mirroring	77, 94, 105
Move	94, 104
Move a File or Folder	153
Move into Hoop	105
Move up One Folder Level	152
Multi-touch screen	12
Multipurpose tool	17
mySewnet account	161
mySewnet cloud	161
mySewnet Cloud	61

mySewnet Folder	151
mySewnet Library	99
mySewnet Services	61
mySewnet Settings	145

N

Needle Area	13
Needle Combination	36
Needle holder with needle clamp screw	13
Needle plate	12
Needle Stop Position	139
Needle stop up/down	15
Needle Thread Breaks	158
Needle thread guide	13
Needles	31
Non-Original Parts and Accessories	161
Non-Stick Glide Foot H for IDF System	18
Number of Stitches in Embroidery Combination	124

O

OK	57, 112
One Color	124
Open a File or Folder	151
Options for Feed Teeth	139
Organize	152
Outer hoop	48
Overcast	83

P

Packing Away After Sewing	27
Pan	105
Park Position	125
Patchwork Program	82
Play/pause	70
Pop-up Messages in Embroidery Edit	116
Pop-up Messages in Embroidery Stitch-Out	129
Pop-up Messages in File Manager	154
Pop-up Messages in Sequence	135
Pop-up Messages in Sewing	89
Pop-up Messages in Stitch Creator™ Feature	95
Positioning in Create Shape/Create Appliqué	115
power button	26
Power button and power symbol	13
Power cord socket	13
Pre-tension thread guide	12
Presser Feet	18
Presser foot	13
Presser foot ankle	13
Presser foot bar	13
Presser foot down and pivot	15
Presser Foot Height Embroidery	141

Presser Foot Pressure.....	79, 139
Presser Foot Recognition.....	146
Presser foot up and extra lift.....	15
Programmable Button Sew On.....	86
Project Creator.....	62
Project Viewer.....	70

Q

Quick Help.....	57
Quick release.....	48

R

Rear.....	13
Recommendations.....	58
release button.....	156
Remaining Embroidery Time.....	124
Removable bobbin holder.....	14
Removing the Embroidery Unit.....	51
Removing the Needle Plate.....	156
Rename a File or Folder.....	152
Repeat combination.....	112
Repeat on/off.....	70
Replacing the Needle Plate.....	156
Resize.....	108
Resize Adjustments.....	108
Retain Fill Type.....	108
Retaining screw.....	48
Reverse.....	15
Review Embroidery Settings.....	141
Review the Embroidery Stitch-Out Settings.....	121
Rewind.....	70
Ribs for fitting the clips.....	48
Right Side.....	13
Rotate.....	104
Rotate handle.....	112, 114
Ruler with button ruler.....	12

S

Save.....	56
Save Current State/Restore Current State.....	128
Save Design.....	116
Save Stitch.....	81
Saving a Sequence.....	135
Scale.....	104
Scale handles.....	112, 114
Seam.....	83
Seam ripper.....	17
Secondary Top Bar.....	58
Select All.....	93, 103
Select Default Hoop Size.....	141
Select Designs/Change Stitch-Out Order.....	103

Select Hoop.....	106
Select Line Positioning.....	115
Select Multiple.....	93, 103, 151
Select Side Positioning.....	115
Select Spacing.....	111, 115
Select Stitches/Stitch Points.....	93
Select Text Shape.....	110
Selected Foot Type.....	121
Selected Hoop.....	121
Selecting Correct Thread.....	36
Self-Adhesive Glide Plates.....	19
Sensor One-Step Buttonhole Foot.....	19
Sensor Q-Foot.....	18, 49, 140
Sequence.....	131
Sequence – Overview.....	132
Sequence Commands.....	134
Service.....	161
Set Cursor Point.....	126
Set Number of Designs/Stitches.....	113
Settings.....	137
Sew or Embroider Your Sequence.....	135
Sewing.....	71
Sewing Mode – Overview.....	72
Sewing Programs.....	81
Sewing Settings.....	138
Sewing Techniques.....	83
Shape line.....	112
Shape menu.....	112, 114
Side-Motion Foot S.....	19
Single Stitch Program.....	82
Slot for needle packs.....	14
Slots/grooves to attach embroidery unit extension and/ or extension table.....	13
Smart Toolbox.....	57
Space for accessories.....	14
Space for needle plate.....	14
Space for seam ripper and brush.....	14
Space with hole for Buttonhole Foot C.....	14
Spaces for presser feet.....	14
Speaker.....	13
Special Stitches For Optional Presser Feet.....	87
Speed Control Slider.....	28
Spool cap.....	17
Spool Caps.....	29
Spool Pins.....	29
Stabilizers.....	69
Start/Stop.....	15
Step Stitch-by-Stitch / Go to Stitch.....	124
Stitch Creator™.....	92
Stitch Density.....	77
Stitch Length.....	77
Stitch Limiting Options.....	139
Stitch menu.....	112, 114
Stitch Menu Overview.....	24
Stitch Out an Appliqué.....	115
Stitch Overview.....	20
Stitch Positioning.....	77
Stitch Repeat.....	81

Stitch restart.....	15
Stitch Settings.....	76
Stitch Width.....	77
Stitch-Out Progress.....	124
Stop.....	15
Storing a Needle Plate.....	45
Straight Stitch Plate.....	17, 49
Stretch Fabrics.....	67
Stretch Needle.....	31

T

Tapering Stitches.....	86
Technical Specification.....	161
telescopic thread guide.....	33
Telescopic thread guide.....	12
Telescopic Thread Guide.....	28
Text Shaping.....	110
The Automatic Needle Threader Does Not Work Properly.....	157
The Embroidery Design has Puckered.....	160
The Embroidery Design is Distorted.....	160
The Machine Cannot Connect to a WiFi Network.....	160
The Machine Cannot Synchronize with the mySewnet Cloud.....	161
The Machine Does Not Feed or Feeds Irregularly.....	159
The Machine Skips Stitches.....	158
The Machine will not Embroider.....	160
The Seam has Uneven Stitches.....	159
Theme Stitches.....	88
Thread cone holder.....	17
Thread Cut Options.....	121, 141
Thread cutter.....	12
Thread cutter for bobbin winding.....	13
Thread Loops are Forming on the Underside of the Embroidery Design.....	160
Thread net.....	17
Thread Sensor.....	28
Thread Slides Down on the Standing Thread Spool.....	39
Thread Spool is Pulled up on the Spool Pin.....	39
Thread take-up lever.....	12
Thread Tangles or Curls when Unwinding.....	39
Thread tension discs.....	12
Threading.....	33
Threading for Twin Needle.....	37
Threading slot.....	12
Threading slots.....	12
Threading the Upper Thread.....	33
Threading Tips and Hints.....	39
Threads.....	29
Tie-Off Options.....	80, 139
Time Format.....	142
Time Zone.....	142
Top Bar.....	58
Touch & Hold.....	57
Transparent Thread.....	30
Trim Position.....	125

Triple Stitch.....	94
Troubleshooting.....	157
Turnable Hoop Options – Side Sort.....	122
Twin Needle Options.....	140

U

Undo/Redo.....	105
Universal Needle.....	31
universal tool.....	156
Universal tool.....	17
Unpacking Machine and Embroidery Unit.....	26
USB Device.....	152
USB ports.....	13
USB Ports.....	27
Using a USB Device.....	27
Using Sequence in Sewing Mode and Embroidery Edit.....	135
Using the Automatic Needle Threader.....	35
Using the Hoop Adapter.....	54
Utility Foot A for IDF System.....	18
Utility Stitches 1, Basic Stitches.....	20

V

Vinyl.....	68
------------	----

W

Watch full animation.....	70
WiFi.....	160
WiFi Introduction.....	60
WiFi router.....	160
WiFi Settings.....	144
Winding Through the Needle.....	41
Wing Needle.....	31
Woven fabric.....	67
Woven Fabrics.....	67
Woven or Knit.....	67

Z

Zipper Foot E for IDF System.....	18
Zoom Options.....	94, 106, 125

You have purchased a modern, updatable sewing and embroidery machine. As we regularly release firmware updates, it is possible that there may be some differences between the machine firmware and the firmware described in the user's guide. Consult your local authorized HUSQVARNA® VIKING® retailer, and be sure to visit our website at www.husqvarnaviking.com for the latest updates of the firmware and the user's guide.

We reserve the right to change the machine equipment and the assortment of accessories without prior notice, or make modifications to the performance or design. Such modifications, however, will always be to the benefit of the user and the product.

INTELLECTUAL PROPERTY

Patents protecting this product are listed on a label positioned underneath the Sewing Machine.

DELUXE, DESIGNER, DESIGNER EPIC, EXCLUSIVE SENSOR SYSTEM, 164, JOYOS ADVISOR, MYSEWNET, VIKING, and KEEPING THE WORLD SEWING & Design are trademarks of KSIN Luxembourg II, S.a.r.l.

HUSQVARNA and the "crowned H-mark" are trademarks of Husqvarna AB. All trademarks are used under license by VSM Group AB.



Please note that on disposal, this product must be safely recycled in accordance with relevant National legislation relating to electrical/electronic products. Do not dispose of electrical appliances as unsorted municipal waste, use separate collection facilities. Contact your local government for information regarding the collection systems available. When replacing old appliances with new ones, the retailer may be legally obligated to take back your old appliance for disposal free of charge.

If electrical appliances are disposed of in landfills or dumps, hazardous substances can leak into the groundwater and get into the food chain, damaging your health and well-being.



FR

Cet appareil, ses accessoires et piles se recyclent

À DÉPOSER EN MAGASIN



À DÉPOSER EN DÉCHÈTERIE



OU

Points de collecte sur www.quefairedemesdechets.fr
Privilégiez la réparation ou le don de votre appareil !



FR



Importer to the UK:

VSM UK

Ravensbank House, Ravensbank Drive

North Moons Moat, Redditch. B98 9NA, United Kingdom

Manufacturer

VSM GROUP AB, **SVP Worldwide**

Soldattorpsgatan 3, SE-54474, Jonkoping, SWEDEN



www.husqvarnaviking.com